

Ultralight dark matter searches with **KAGRA** gravitational wave telescope

Yuta Michimura

Department of Physics, University of Tokyo

michimura@phys.s.u-tokyo.ac.jp

Tomohiro Fujita, Jun'ya Kume, Soichiro Morisaki, Koji Nagano,
Hiromasa Nakatsuka, Atsushi Nishizawa, Ippei Obata

Slides are available at <https://tinyurl.com/YM20210901>

Ultralight Dark Matter

- Ultralight DM ($< \sim 1$ eV) behaves as classical wave fields

$$f = 242 \text{ Hz} \left(\frac{m_{\text{DM}}}{10^{-12} \text{ eV}} \right)$$

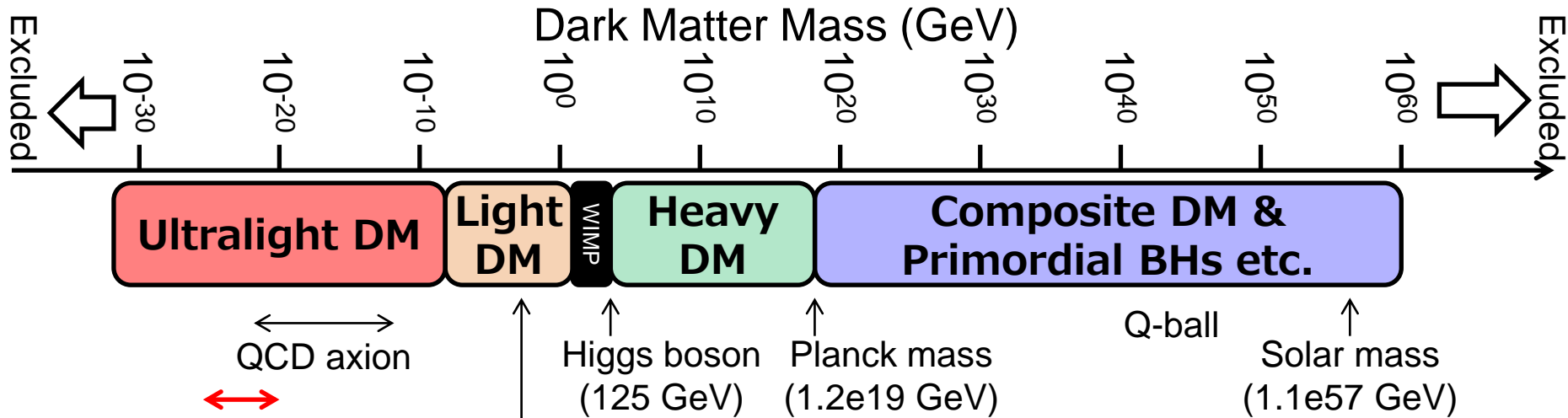

2.4 Hz ~ 2.4 kHz
(1e-14 ~ 1e-11 eV)

Laser Interferometry [arXiv:2006.09721](https://arxiv.org/abs/2006.09721)

XENON1T limits on ALP
(1-210 keV)

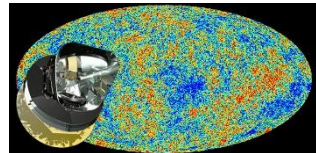
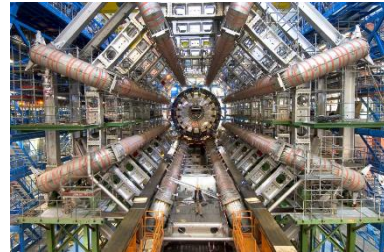

Laser Interferometry

- Sensitive to length / speed of light changes

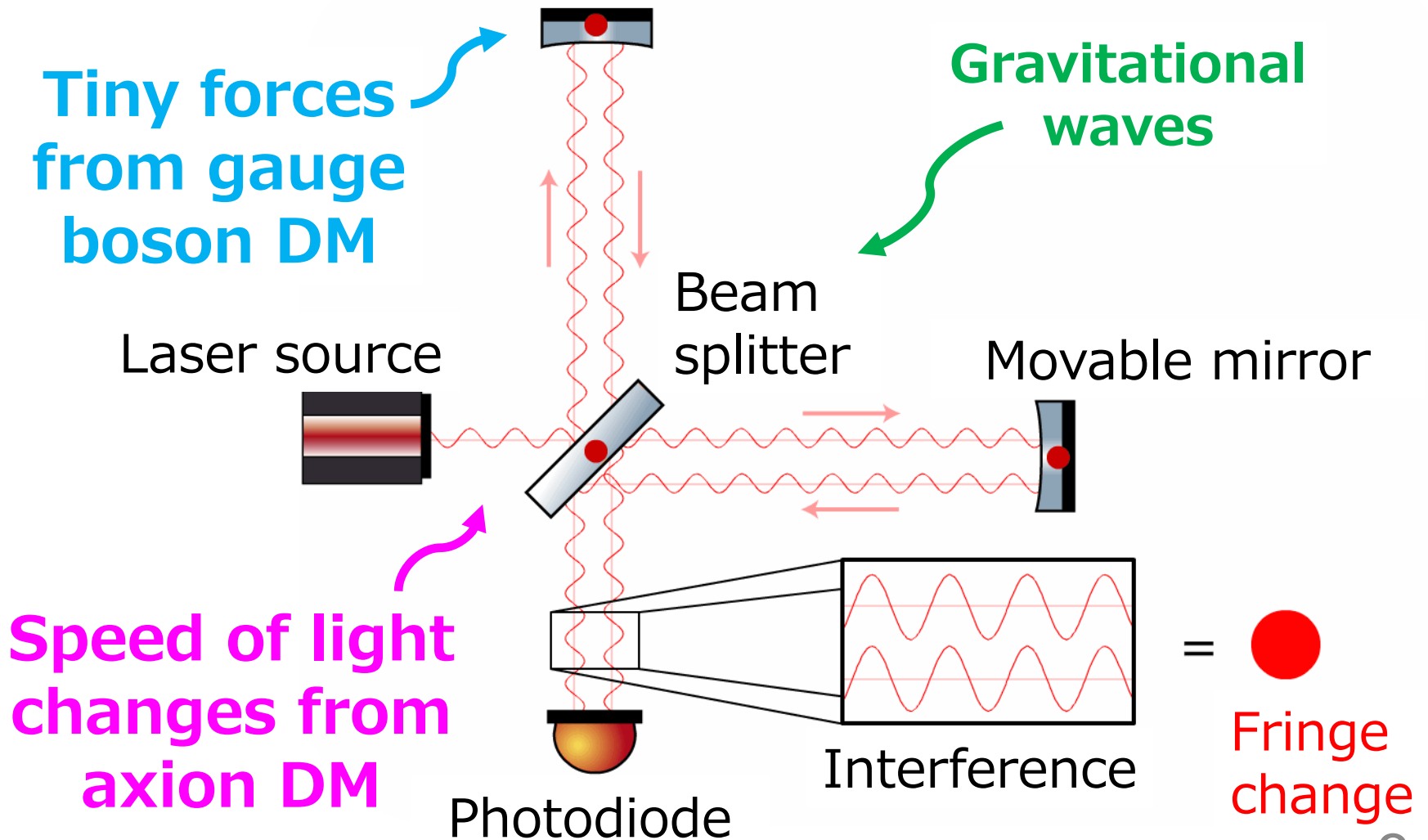

Dark Matter Search with KAGRA

- Use underground, cryogenic gravitational wave detector KAGRA in Japan to search for ultralight dark matter

Ultralight DM

Axion like particles

Gauge bosons

[PRL 123, 111301 \(2019\)](#)
[arXiv:2106.06800](#)
(PRD accepted)

Polarization measurement

[PRD 102, 102001 \(2020\)](#)
[PRD 103, L051702 \(2021\)](#)



Axion and Axion-Like Particles

- Pseudo-scalar particle originally introduced to solve **strong CP problem** (QCD axion)
- Various axion-like particles (ALPs) predicted by string theory and supergravity
- Many experiments to search for ALPs through **axion-photon coupling**
Especially by using **magnetic fields**

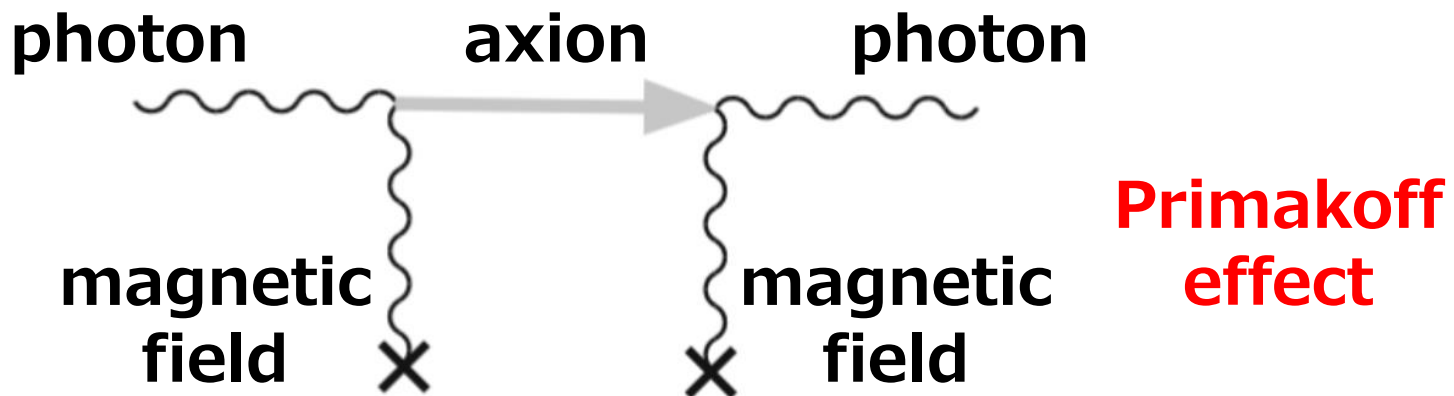

Previous Searches

Light Shining through Wall (ALPS etc.)

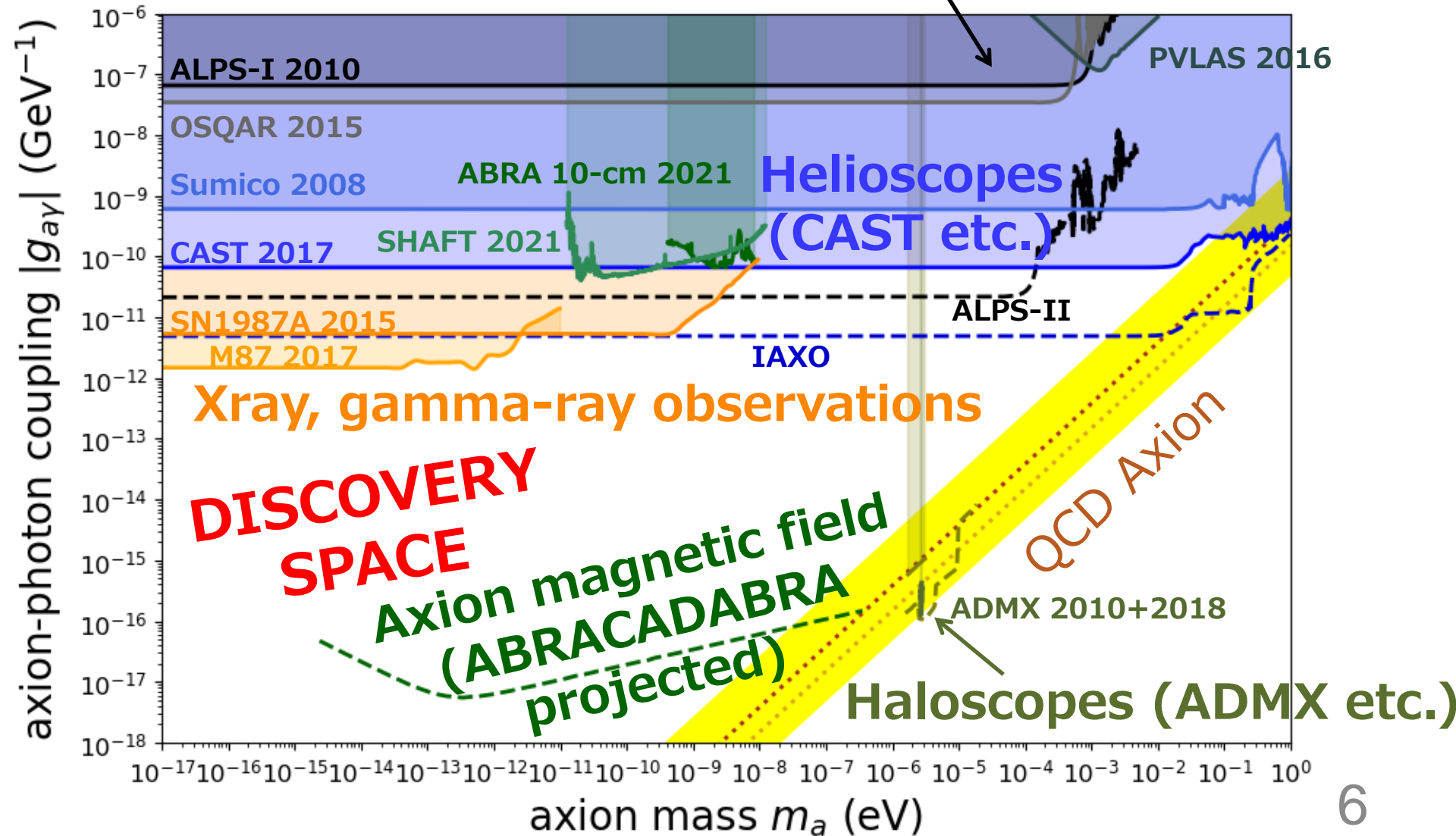

Polarization Modulation from Axions

- Axion-photon coupling ($\frac{g_{a\gamma}}{4} a F_{\mu\nu} \tilde{F}^{\mu\nu}$) gives **different phase velocity** between left-handed and right-handed circular polarizations

$$c_{L/R} = \sqrt{1 \pm \frac{g_{a\gamma} a_0 m_a}{k} \sin(m_a t + \delta_\tau)}$$

coupling constant
axion field
axion mass

- Linear polarization will be **modulated**
p-pol sidebands will be generated from s-pol
- Search can be done **without magnetic field**

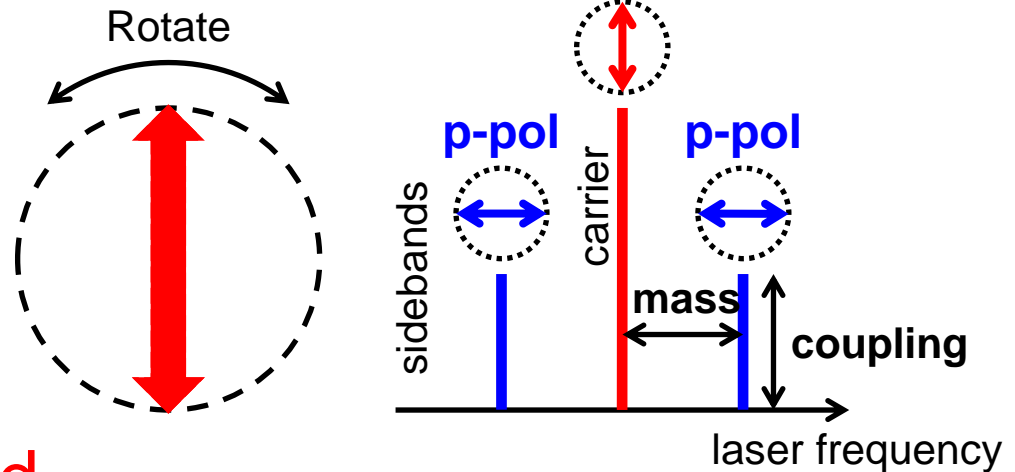

Linear Cavities for Axion Search

- Polarization flip at mirror reflection can be used to enhance the signal when the **round-trip time equals** odd-multiples of **axion oscillation period**
- Long baseline linear cavities in **gravitational wave detectors** are suitable

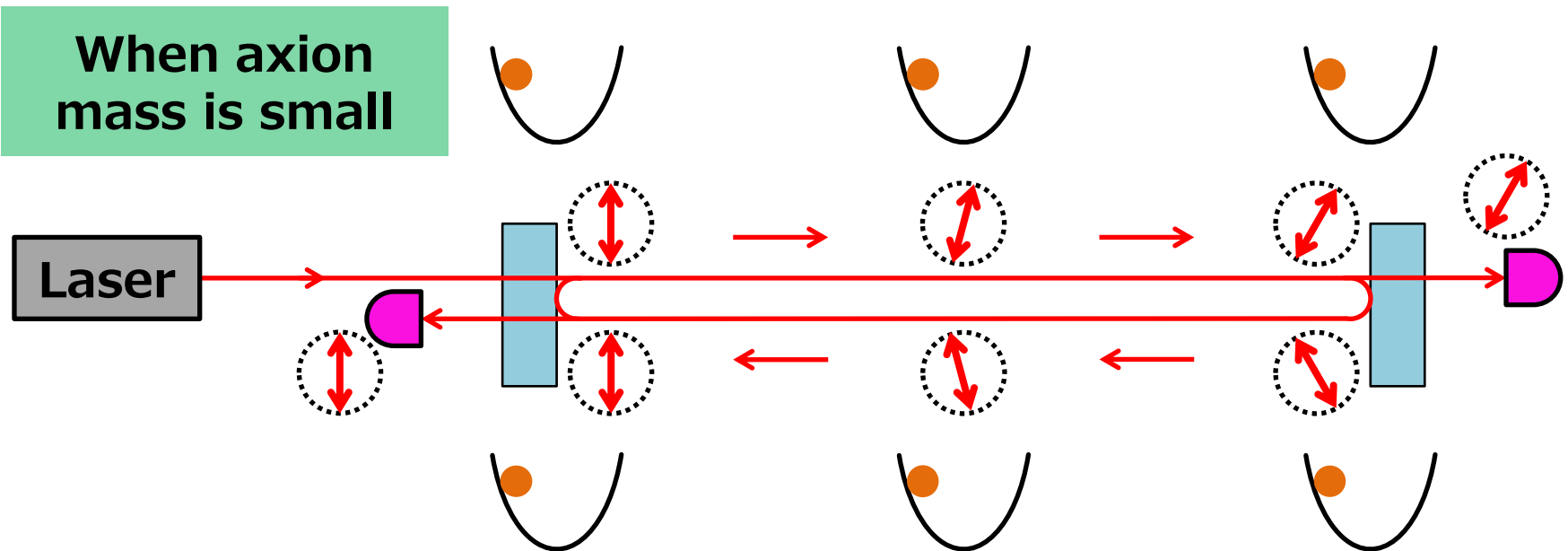

Linear Cavities for Axion Search

- Polarization flip at mirror reflection can be used to enhance the signal when the **round-trip time equals** odd-multiples of **axion oscillation period**
- Long baseline linear cavities in **gravitational wave detectors** are suitable

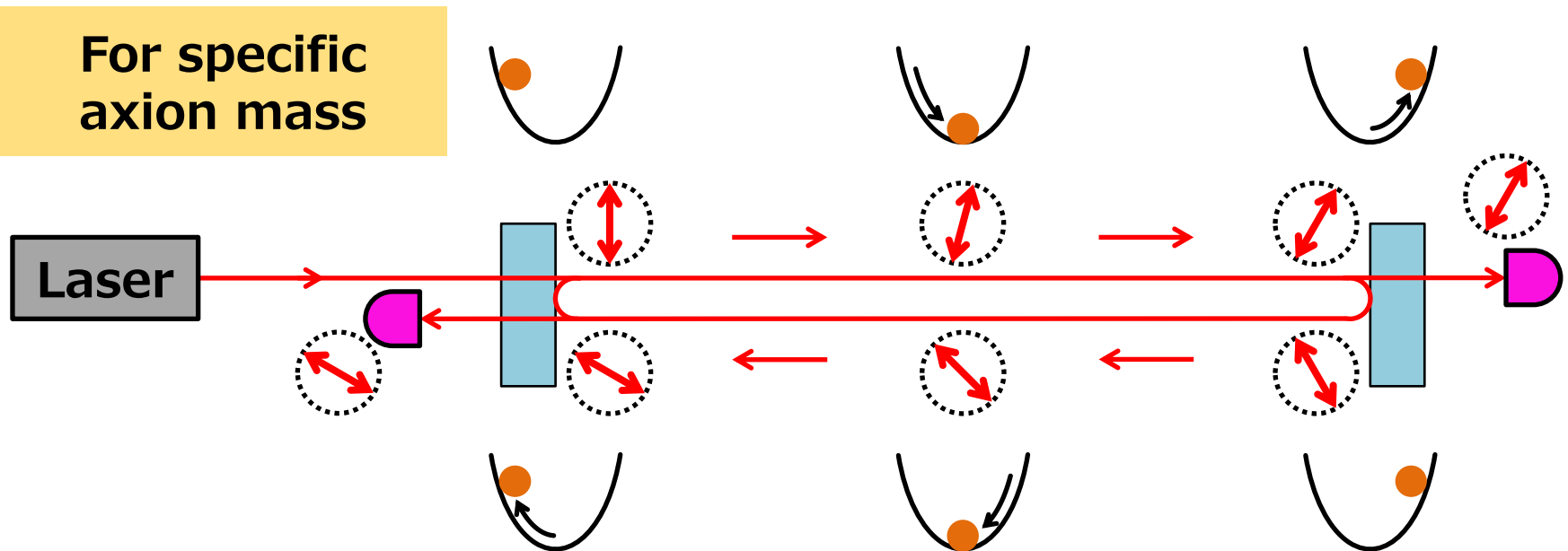

Axion Search with KAGRA

- Axion search and GW observation can be done **simultaneously**

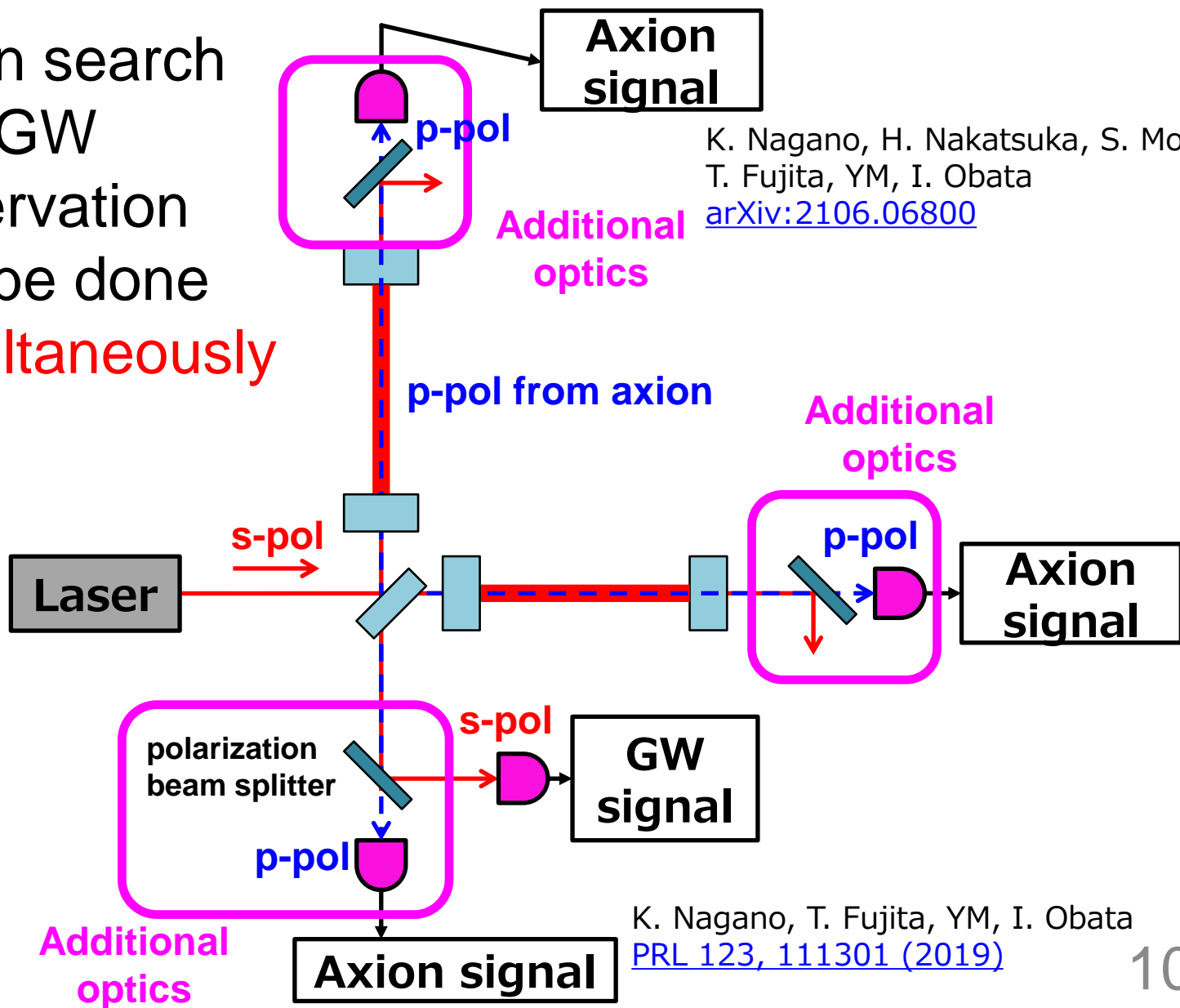

K. Nagano, H. Nakatsuka, S. Morisaki,
T. Fujita, YM, I. Obata
[arXiv:2106.06800](https://arxiv.org/abs/2106.06800)

K. Nagano, T. Fujita, YM, I. Obata
[PRL 123, 111301 \(2019\)](https://doi.org/10.1126/science.1211301)

KAGRA Axion Sensitivity

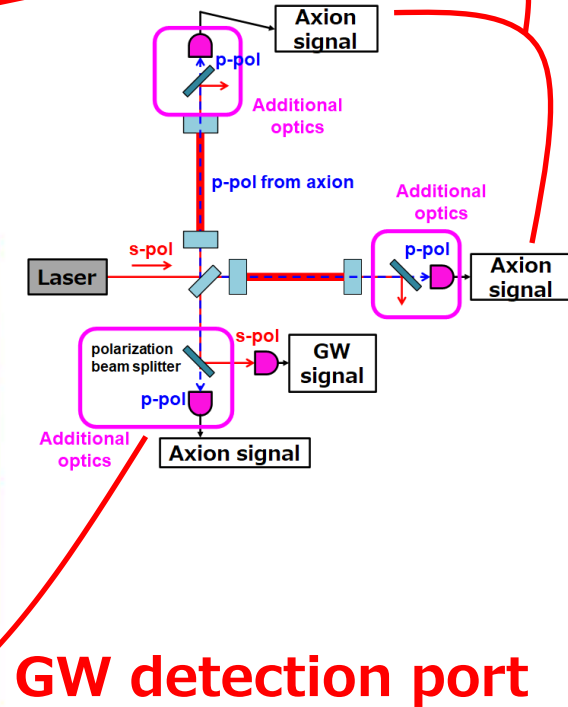
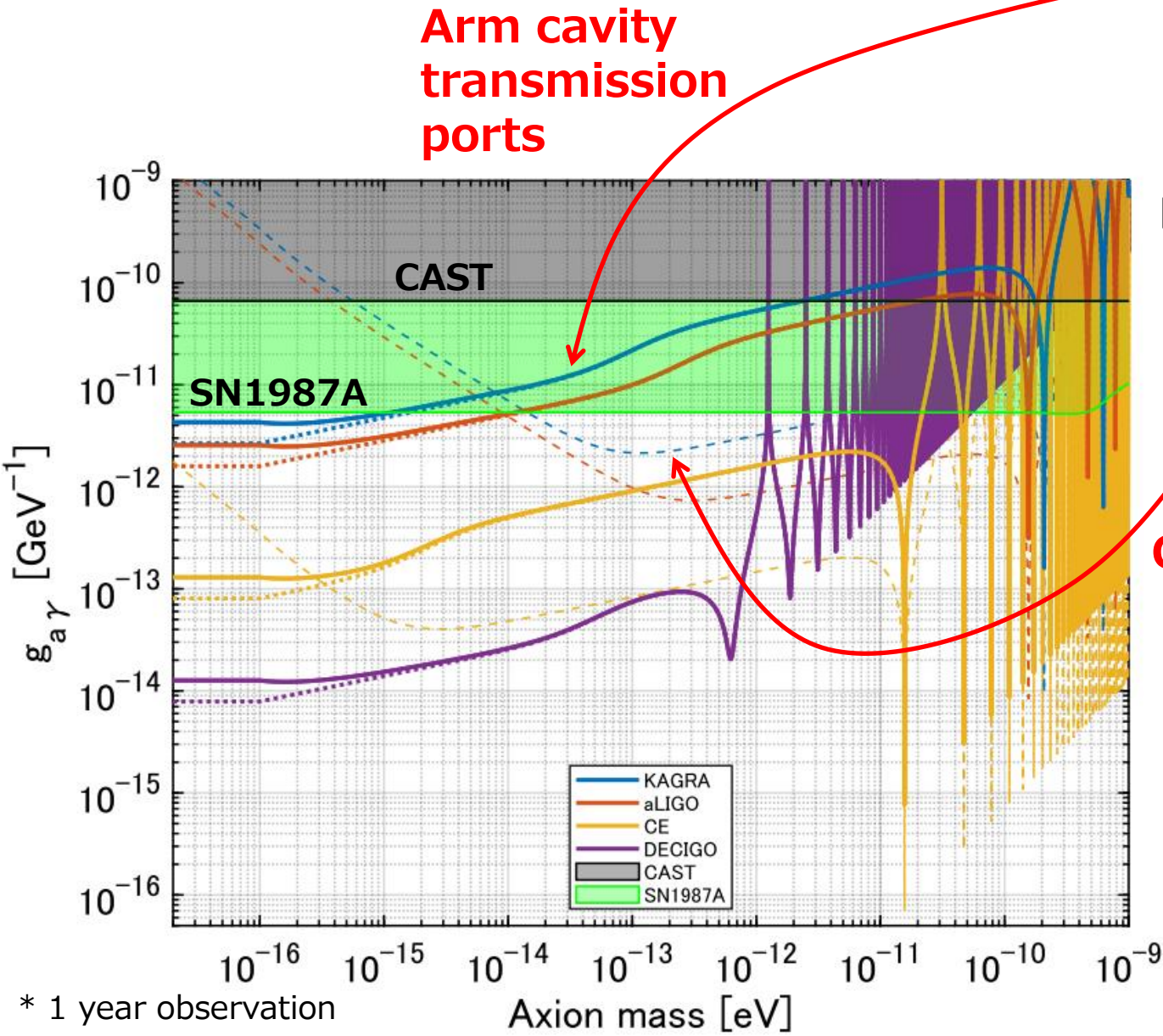

GW detection port

Complemental search using different ports

* 1 year observation

Optics for Axion Search Installed

- Polarization optics mostly installed at X-arm transmission port
- Connected to the data acquisition system
- Axion search to be done in the next observing run O4 in 2022-2023

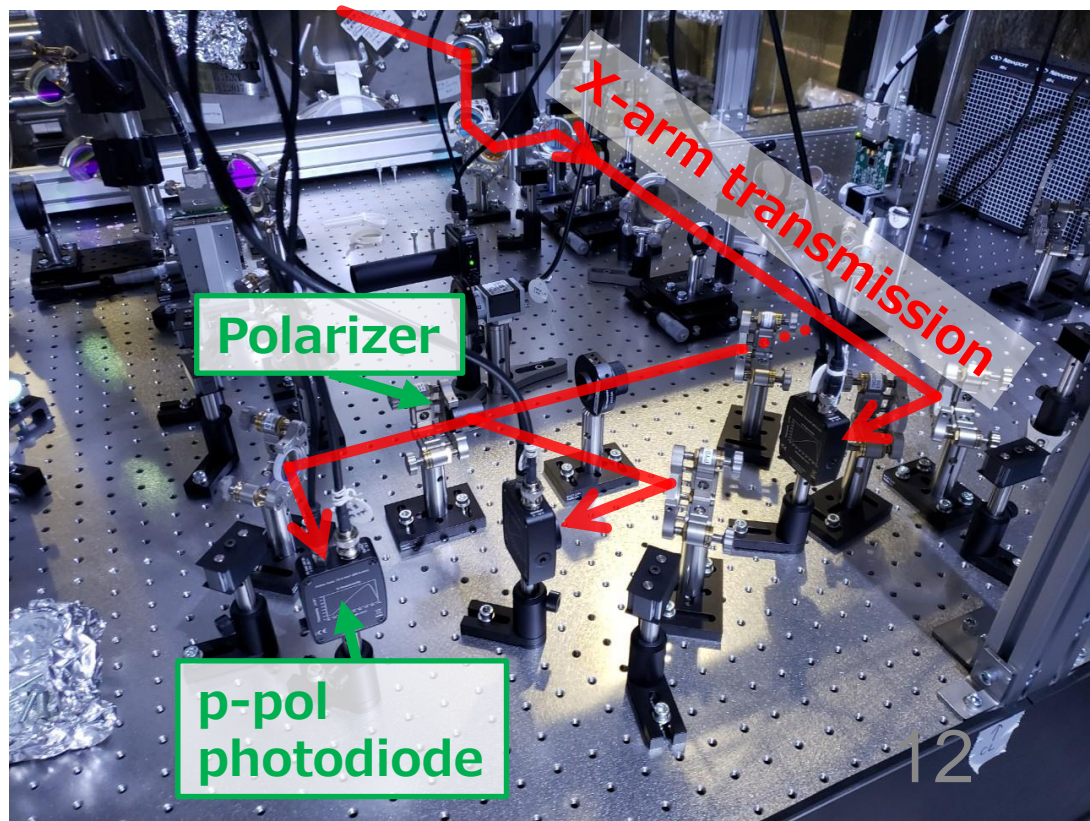

[klog #17692](#)

Gauge Boson

- Possible **new physics** beyond the standard model:
New gauge symmetry and gauge boson
- New gauge boson can be dark matter
- **B-L** (baryon minus lepton number)
 - Conserved in the standard model
 - Can be gauged without additional ingredients
 - Equals to the number of neutrons
 - Roughly 0.5 per neutron mass,
but slightly **different between materials**
Fused silica: 0.501
Sapphire: 0.510
- Gauge boson DM
gives **oscillating force**

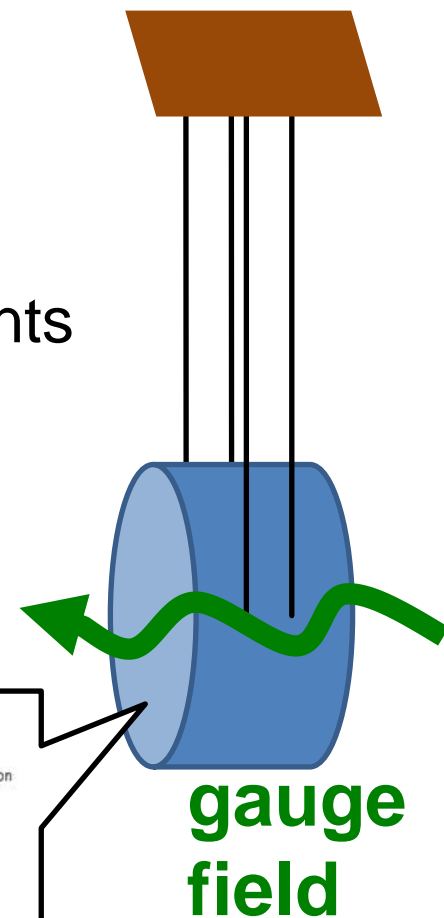
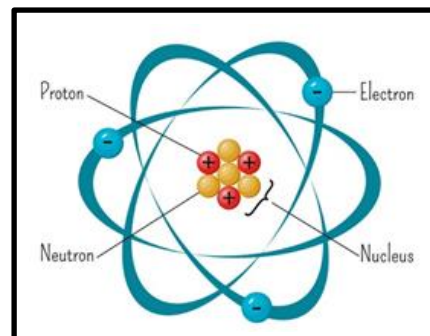

Oscillating Force from Gauge Field

- Acceleration of mirrors

$$\vec{a}(t, \vec{x}) = \epsilon_D e \frac{q_D}{M} \sqrt{2\rho_{DM}} \vec{e}_A \sin(m_A t - \vec{k} \cdot \vec{x})$$

charge (pointing to q_D)
 gauge boson mass (pointing to m_A)
 coupling (pointing to $\epsilon_D e$)
 mirror mass (pointing to M)
 DM density (pointing to ρ_{DM})
 polarization (pointing to \vec{e}_A)
 different phase at different position (pointing to $\vec{k} \cdot \vec{x}$)

- Gauge boson mass and coupling can be measured by measuring the **oscillating** mirror displacement
- Almost no signal for symmetric cavity if cavity length is short (phase difference is 10^{-5} rad @ 100 Hz for km cavity)

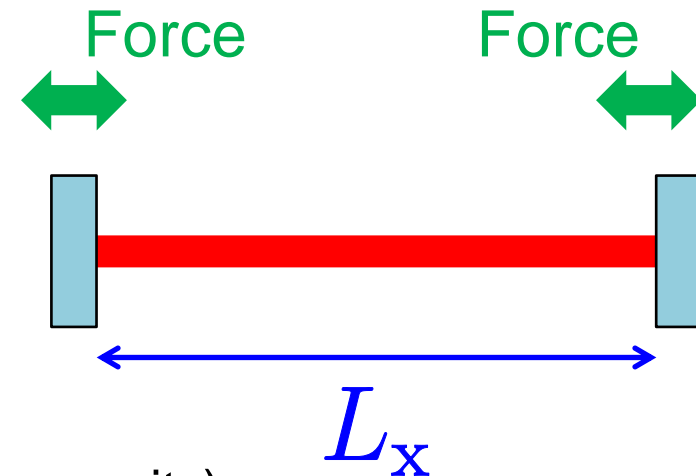

- How about using interferometric **GW detectors**?

Search with GW Detectors

- GW Detectors are sensitive to differential arm length (**DARM**) change
- Most of the signal is cancelled out

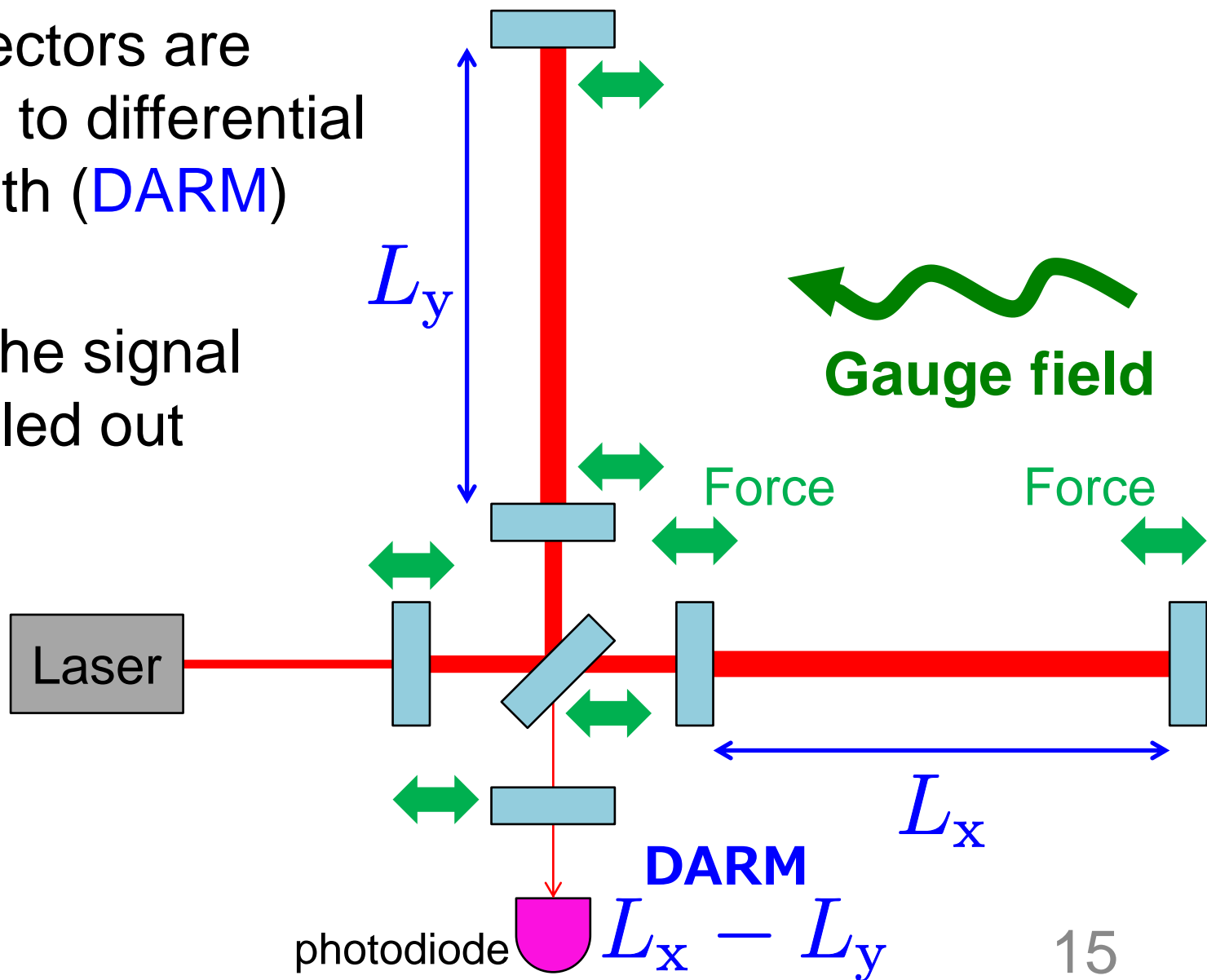

Previous Search with LIGO/Virgo

- Gauge boson dark matter search with **LIGO O1** data and **LIGO/Virgo O3** data have been done
H-K Guo+, [Communications Physics 2, 155 \(2019\)](#)
LIGO, Virgo, KAGRA Collaboration, [arXiv:2105.13085](#)
- **Better constraint** than equivalence principle tests
So far searches focus on $U(1)_B$ baryon number coupling

- Why repeat the search with KAGRA?

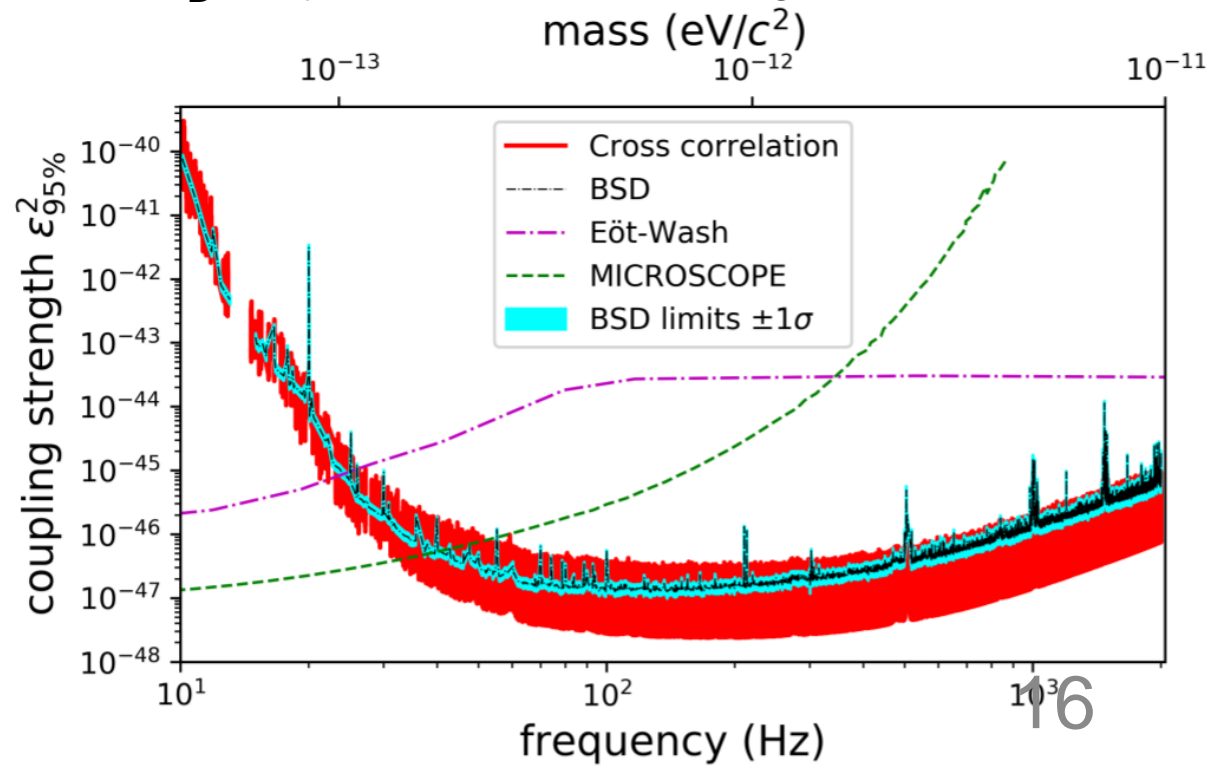

Search with GW Detectors

- GW Detectors are sensitive to differential arm length (**DARM**) change
- Most of the signal is **cancelled out** (LIGO/Virgo case)

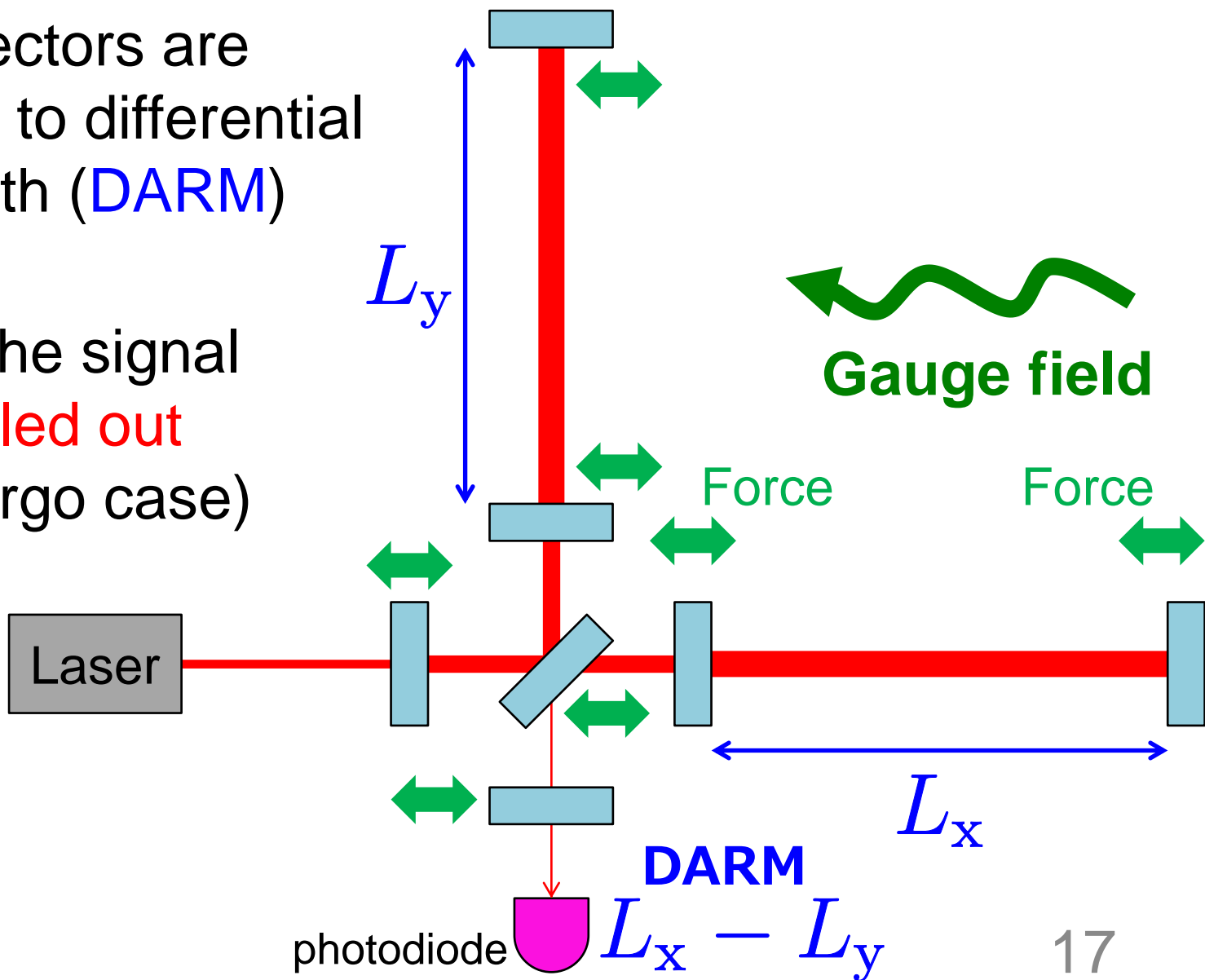

Search with KAGRA



- KAGRA uses cryogenic **sapphire mirrors** for arm cavities, and fused silica mirrors for others
- KAGRA can do **better than LIGO/Virgo** which uses fused silica for all the mirrors

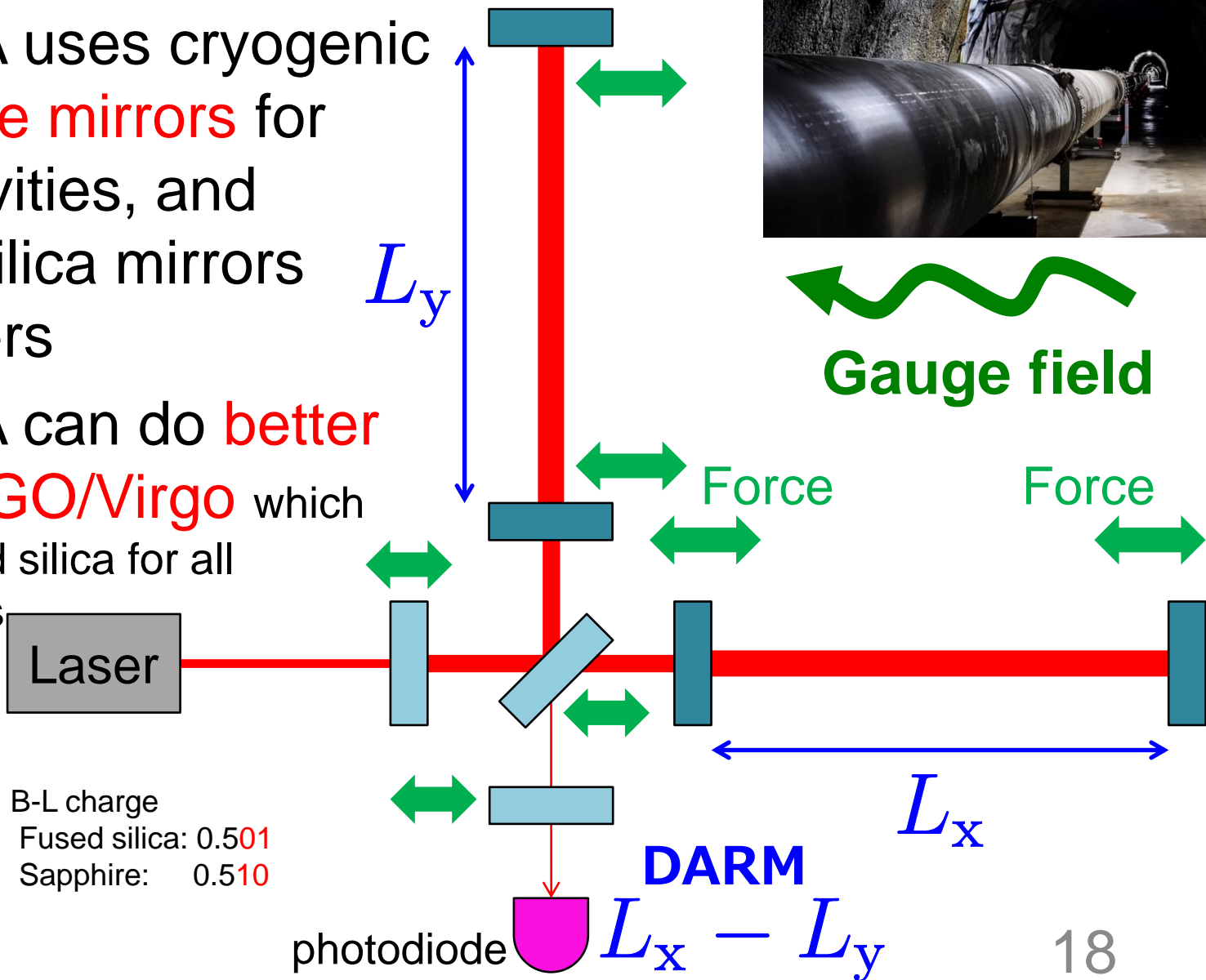

B-L charge
 Fused silica: 0.501
 Sapphire: 0.510

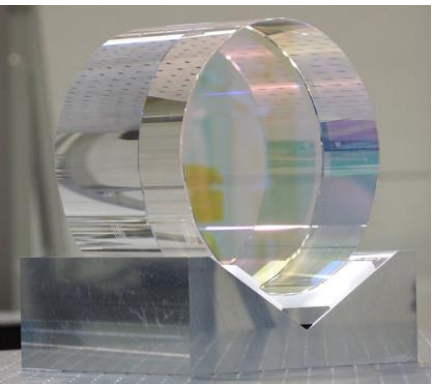

Search with KAGRA



- By measuring the **lengths of auxiliary part** of the interferometer, force difference between sapphire and fused silica can be measured

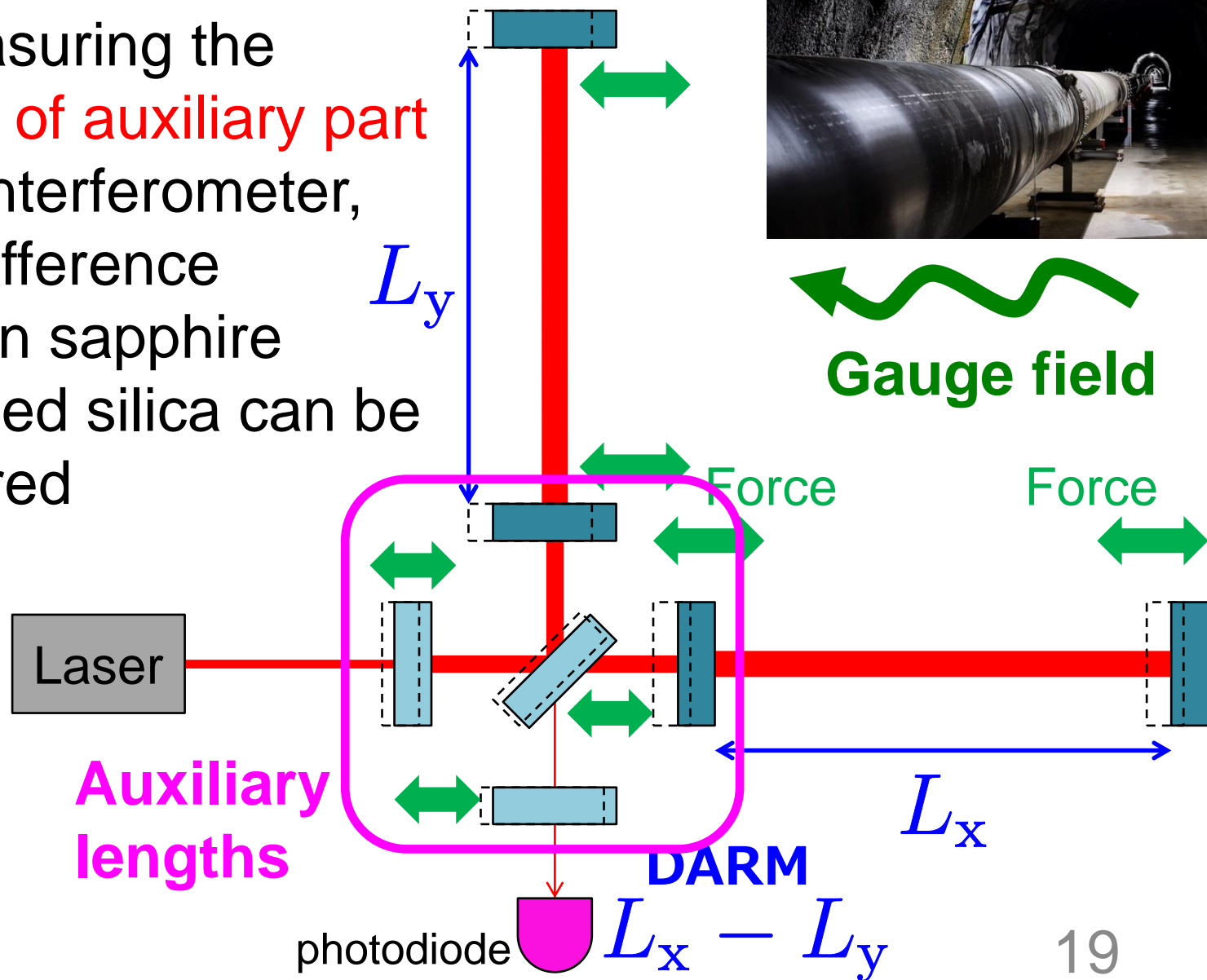

Gauge field

KAGRA Gauge Boson Sensitivity

- Auxiliary length channels have better design sensitivity than DARM (GW channel) at low mass range
- Sensitivity **better than equivalence principle tests**

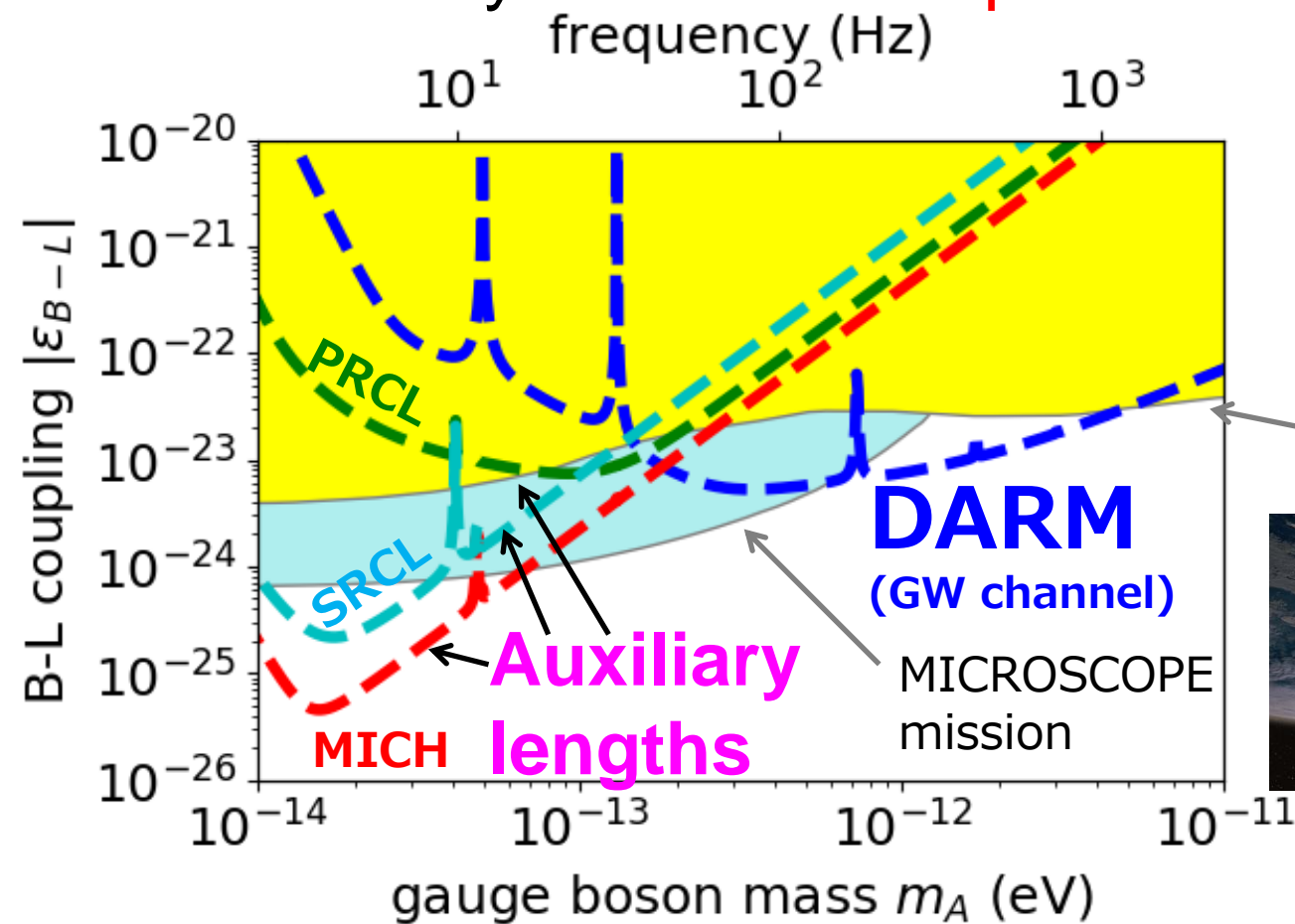

YM, T. Fujita, S. Morisaki,
H. Nakatsuka, I. Obata,
[PRD 102, 102001 \(2020\)](#)

S. Morisaki, T. Fujita, YM,
H. Nakatsuka, I. Obata,
[PRD 103, L051702 \(2021\)](#)

Eöt-Wash
torsion pendulum



KAGRA's Observing Run in 2020

- KAGRA performed joint **observing run in April 2020** with GEO600 (O3GK)
- Displacement sensitivity still not good
~ 6 orders of magnitude to go at 10 Hz
- We have **developed a data analysis pipeline** to search for gauge boson DM
- Applying the pipeline for **two sets of 10^4 sec data**

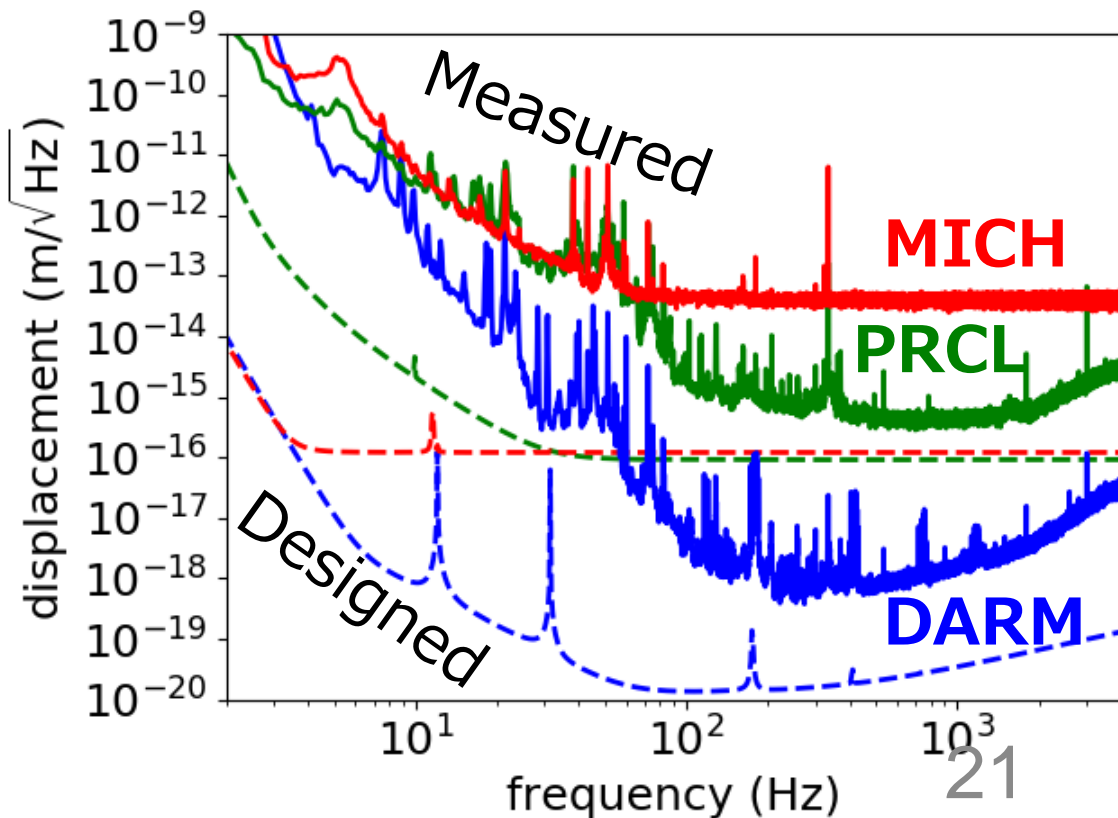

Summary

- Laser interferometers open up **new possibilities** for dark matter search
- Two ultralight DM search activities in KAGRA
 - **Axion DM search**
 - Polarization optics installed**
 - Ready to search in the next observing run O4 in 2022-2023
 - **Gauge boson DM search**
 - First **data analysis** using O3GK 2020 data on going
- Both can be done **simultaneously with gravitational wave observation**
- Stay tuned for future observing runs!