

Conceptual Design of Optical Table Cover for TRX and TRY

Yuta Michimura

Department of Physics, University of Tokyo

Overview

- See [JGW-T1910129](#), [JGW-D1910377](#) and [JGW-D1910654](#) for the basic design
- TRX and TRY covers are similar to those but the size of the optical table is different
- Also, at TRX and TRY, green beam coming out of the TMS chamber have completely different optical path from IR, so the design of the tube is different
- TRX and TRY have the same design

Optical Layout

[JGW-T1808962](#)

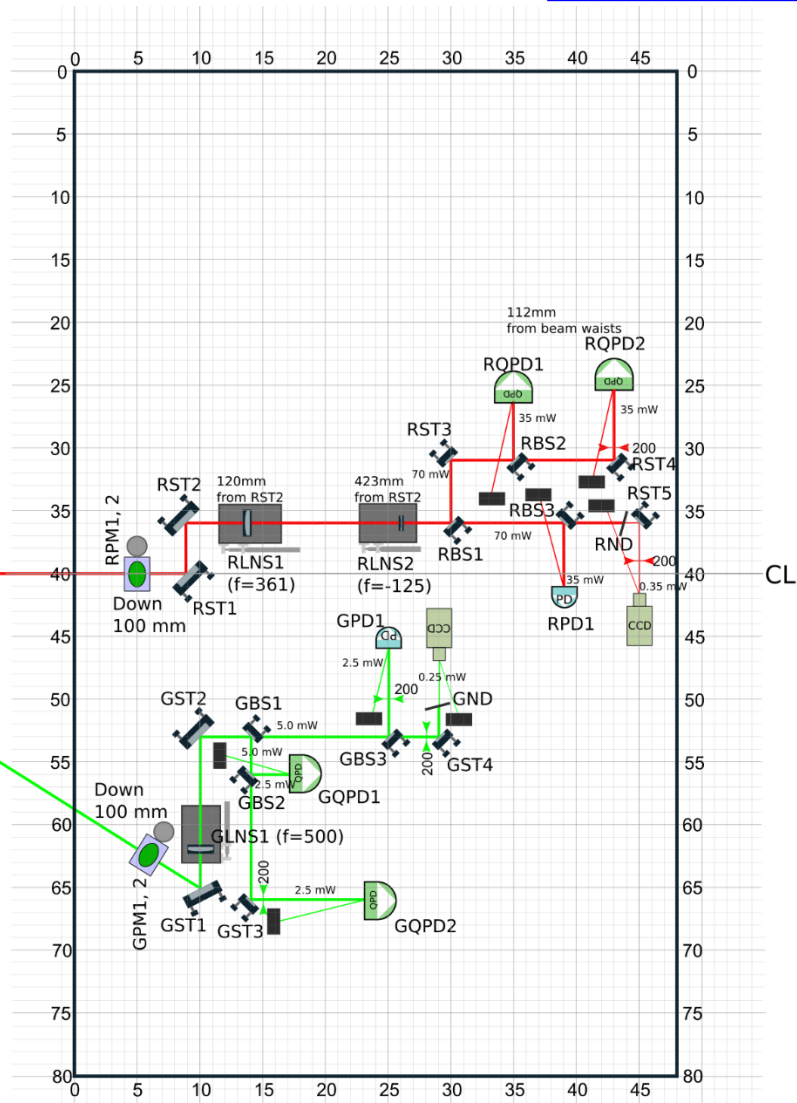
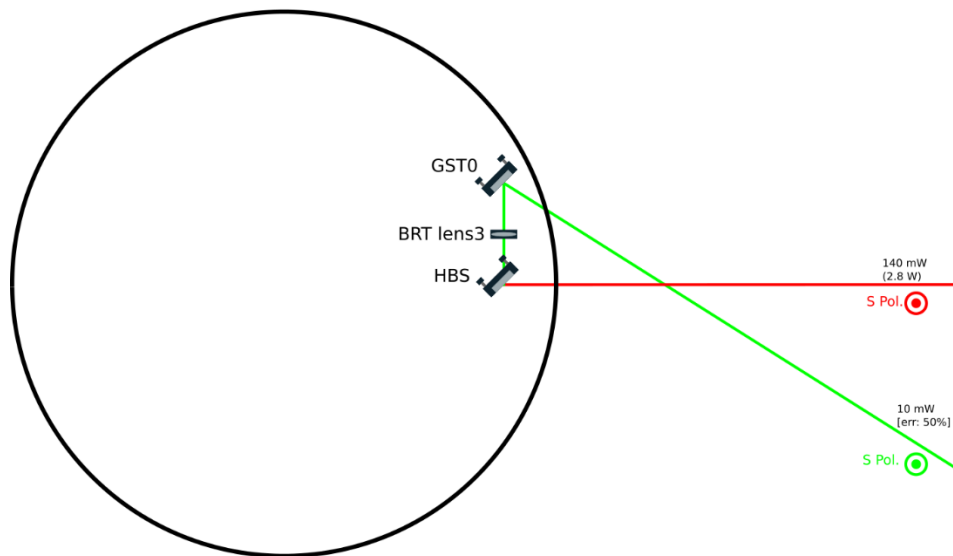

CL

Size of the Tube

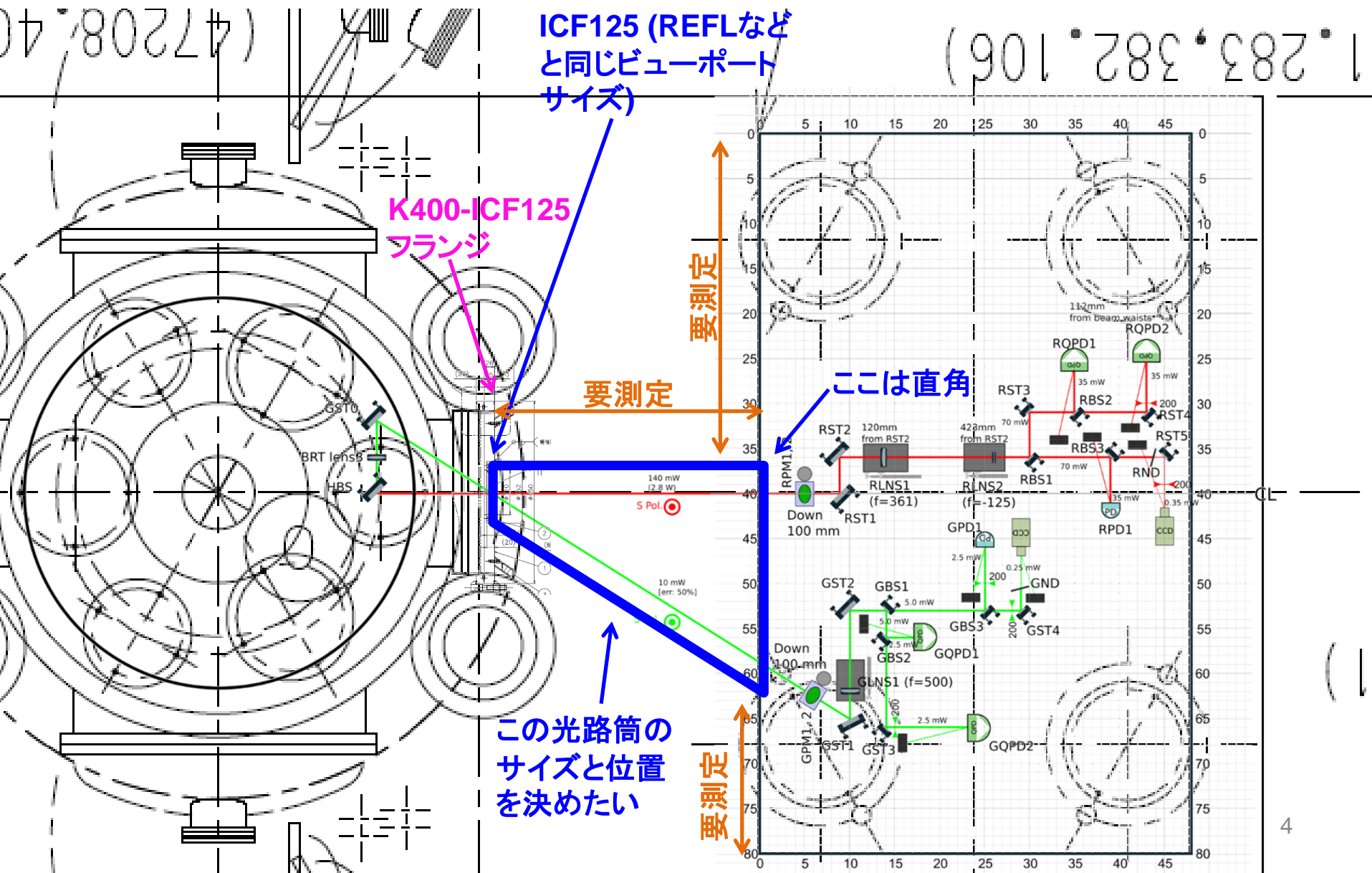

Tube Position

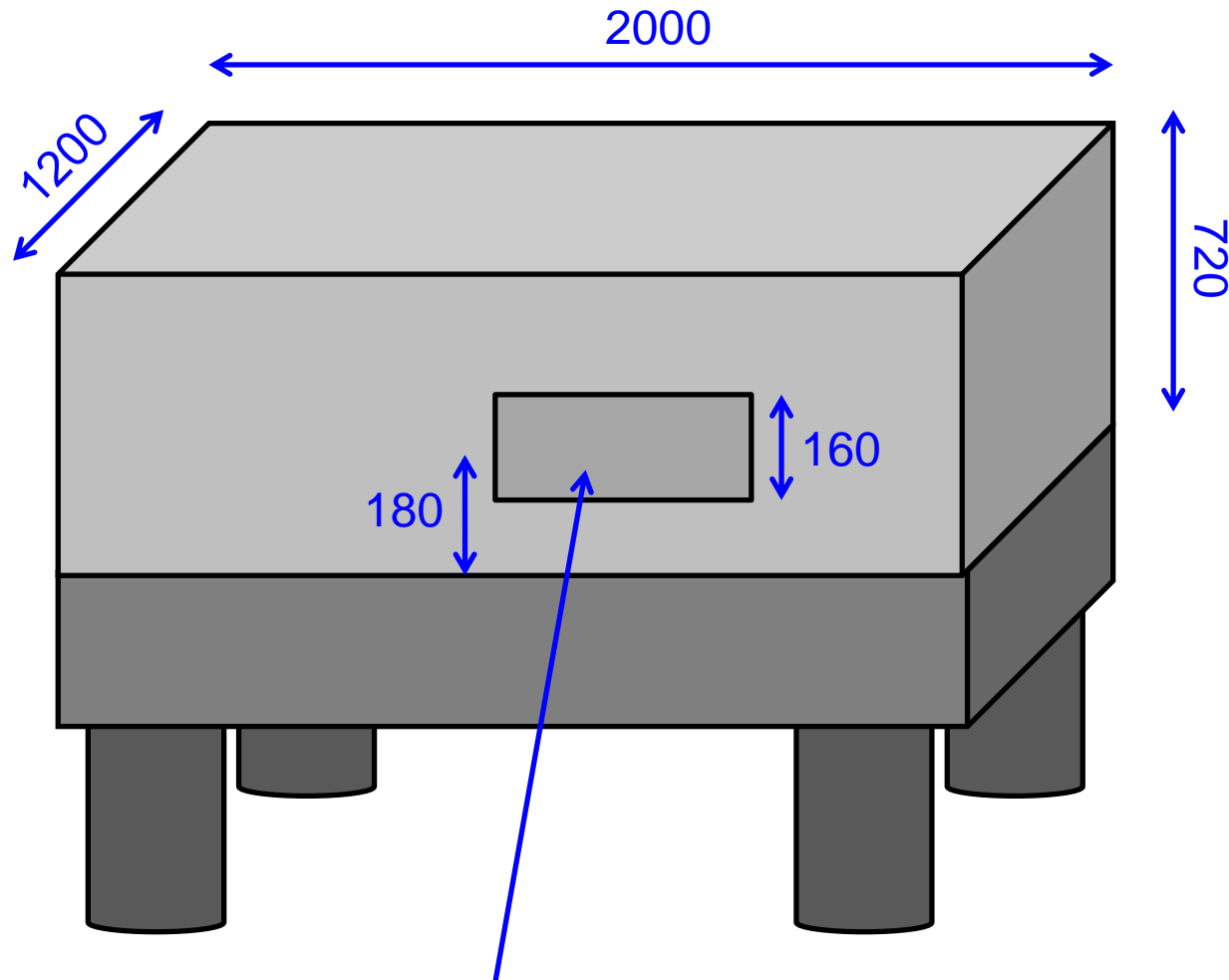

高さ180を中心に高さ160の長方形の穴
に光路筒を設置

Chamber and Optical Table

K400-ICF125フランジがつく

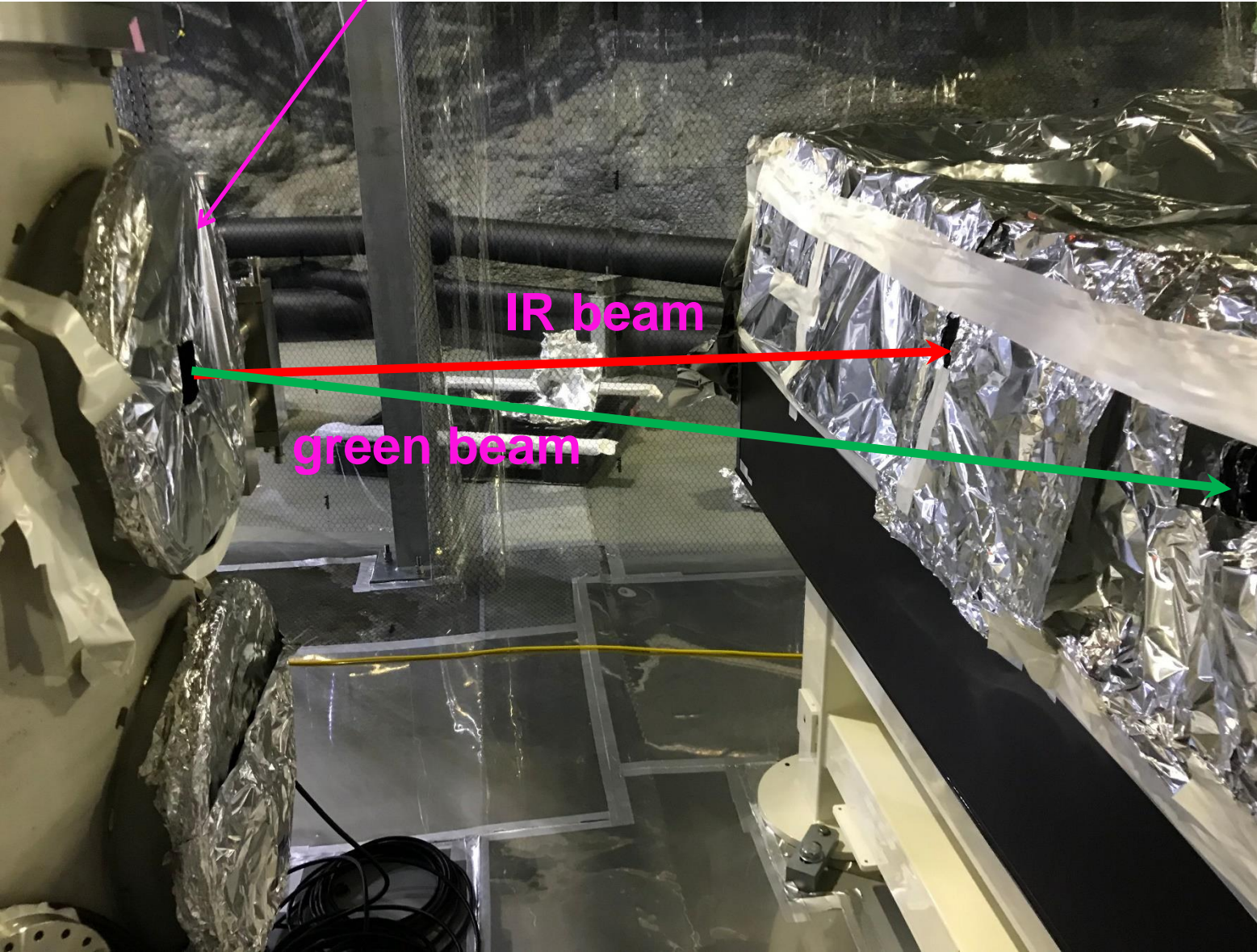

Optical Table

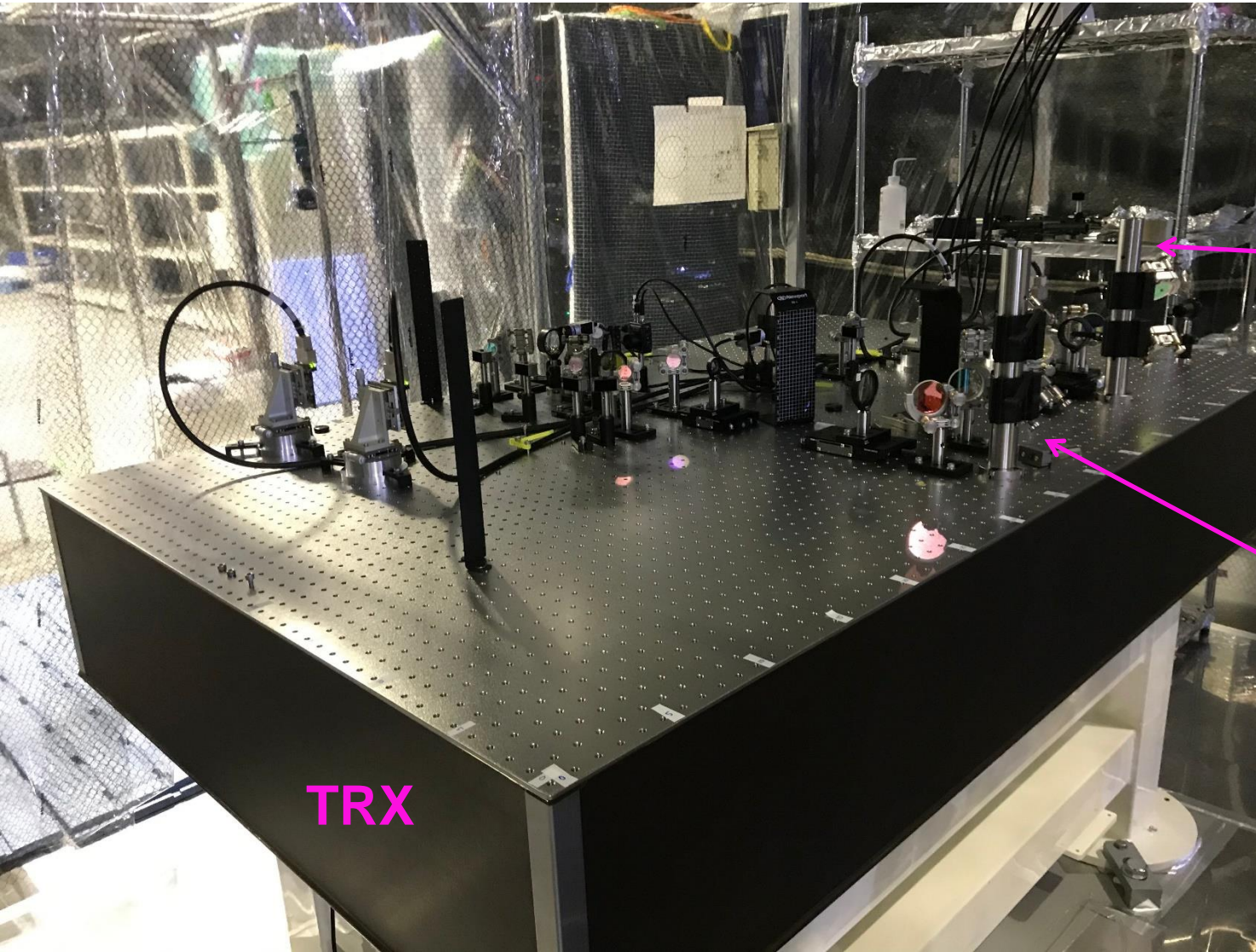

Periscope
for green

Periscope
for IR

TRX

Beam Height

Periscope for IR (~185 mm)

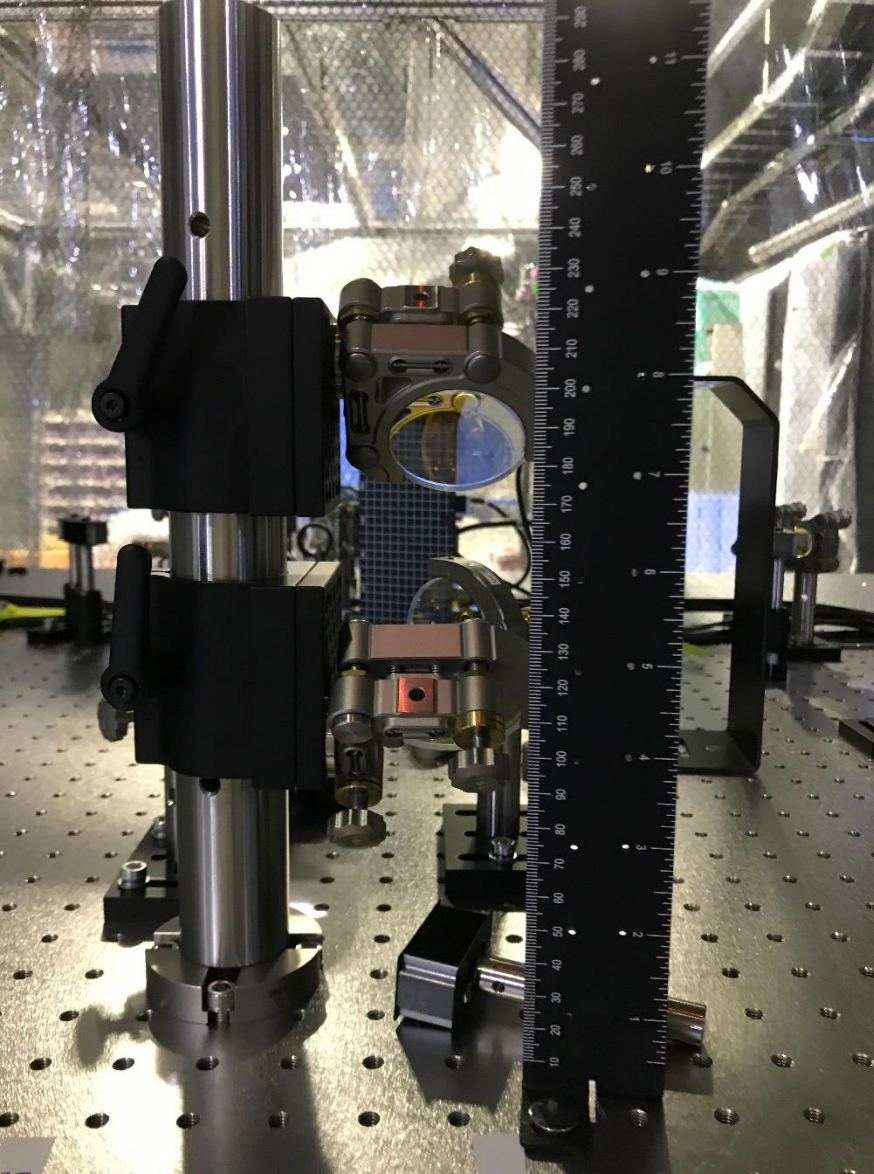

Periscope for green (~180 mm)

