

Ph. D. defense
博士論文審査会

A Study of Baseline Compensation System for Stable Operation of Gravitational-wave Telescopes

(重力波望遠鏡の安定稼働のための基線長補償システムの研究)

Kouseki Miyo
三代 浩世希

January 15th, 2020

JGW-G2011167

Contents

1. Motivation

- Duty cycle of the GW detectors
- Problems of seismic motion in large-scale GW detectors

2. Review of the previous seismic isolation system

- Seismic isolation for stable operation
- Limit of the current system

3. Baseline Compensation System

- Overview
- Comparison between our system and previous system

4. Demonstration and its results

- Setup for demonstration
- Results

5. Summary

- Conclusion
- Future prospects

Contents

1. Motivation

- Duty cycle of the GW detectors
- Problems of seismic motion in large-scale GW detectors

2. Review of the previous seismic isolation system

- Seismic isolation for stable operation
- Limit of the current system

3. Baseline Compensation System

- Overview
- Comparison between our system and previous system

4. Demonstration and its results

- Setup for demonstration
- Results

5. Summary

- Conclusion
- Future prospects

Gravitational wave observation

Sensitivity

10



Event Rate

1000

Duty cycle $\doteq D_1 \times D_2 \times D_3 \times \dots$

(D_i : duty cycle of the i -th detector)

e.g. LIGO detector

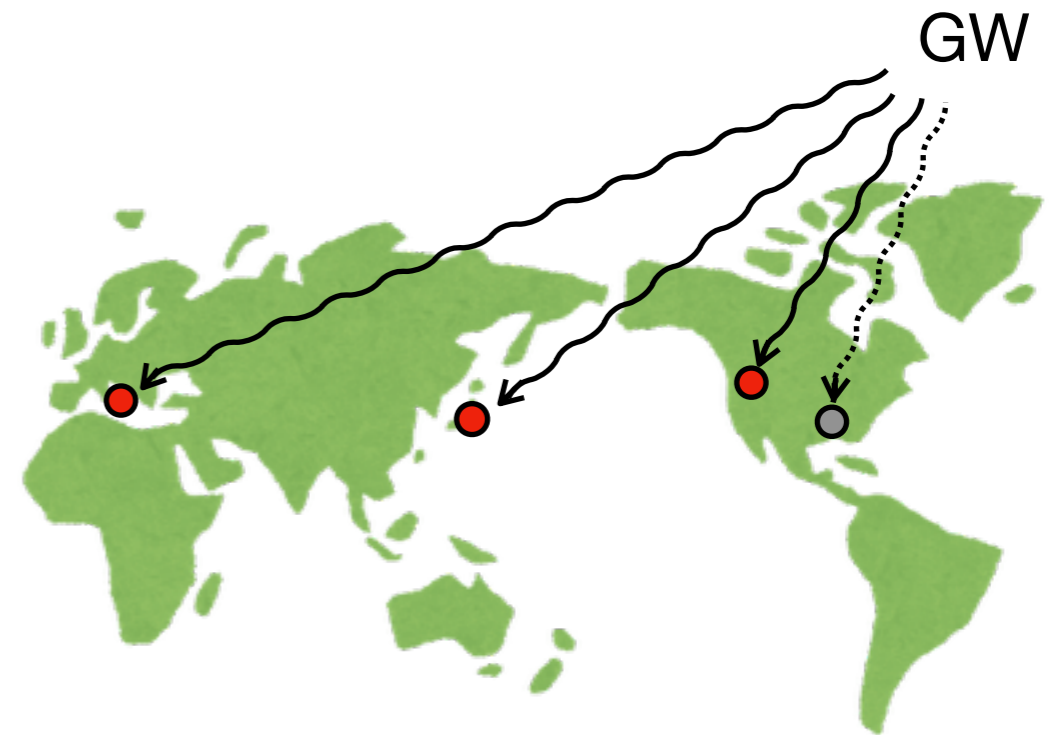
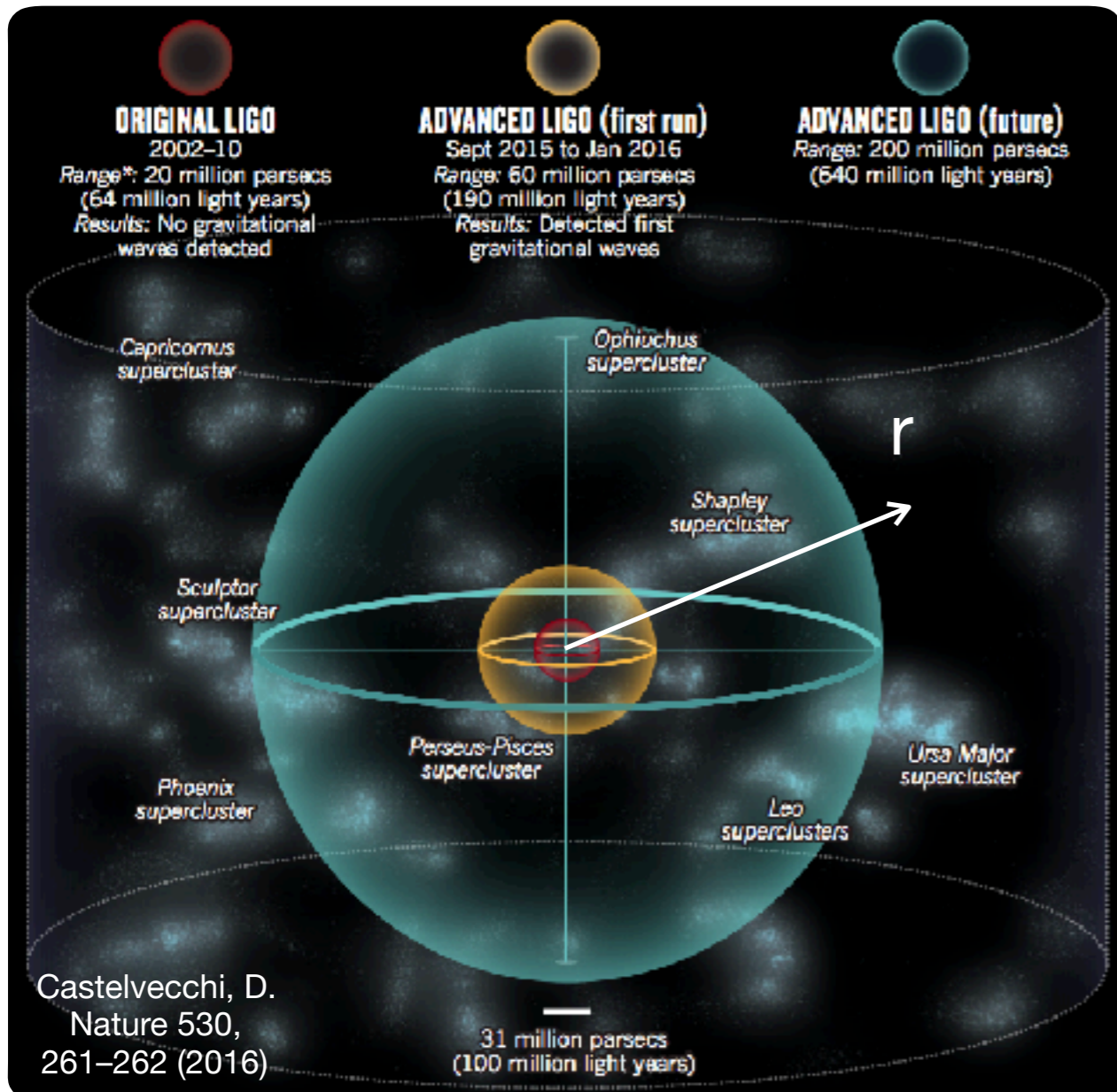

Gravitational wave observation

$$\begin{aligned} \text{Sensitivity} &\propto \text{range} \\ &\propto (\text{volume})^{1/3} \\ &\propto (\text{event rate})^{1/3} \end{aligned}$$

e.g. LIGO detector

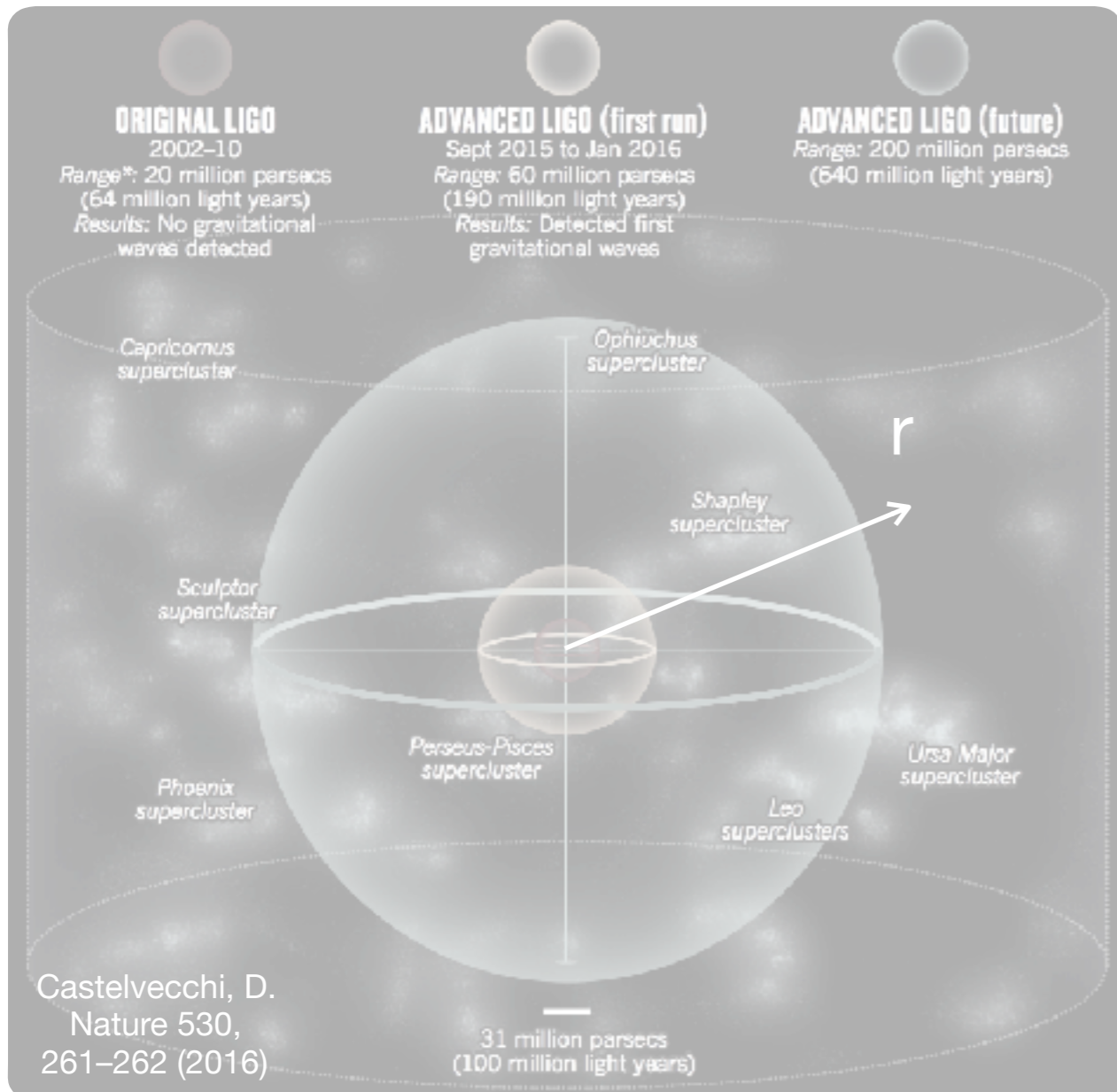

$$\begin{aligned} \text{Duty cycle} &\doteq D_1 \times D_2 \times D_3 \times \dots \\ &(\text{ } D_i \text{ : duty cycle of the } i\text{-th detector }) \end{aligned}$$

This study focuses on this



None-observation state

e.g. LIGO detectors during the first observation (O1)

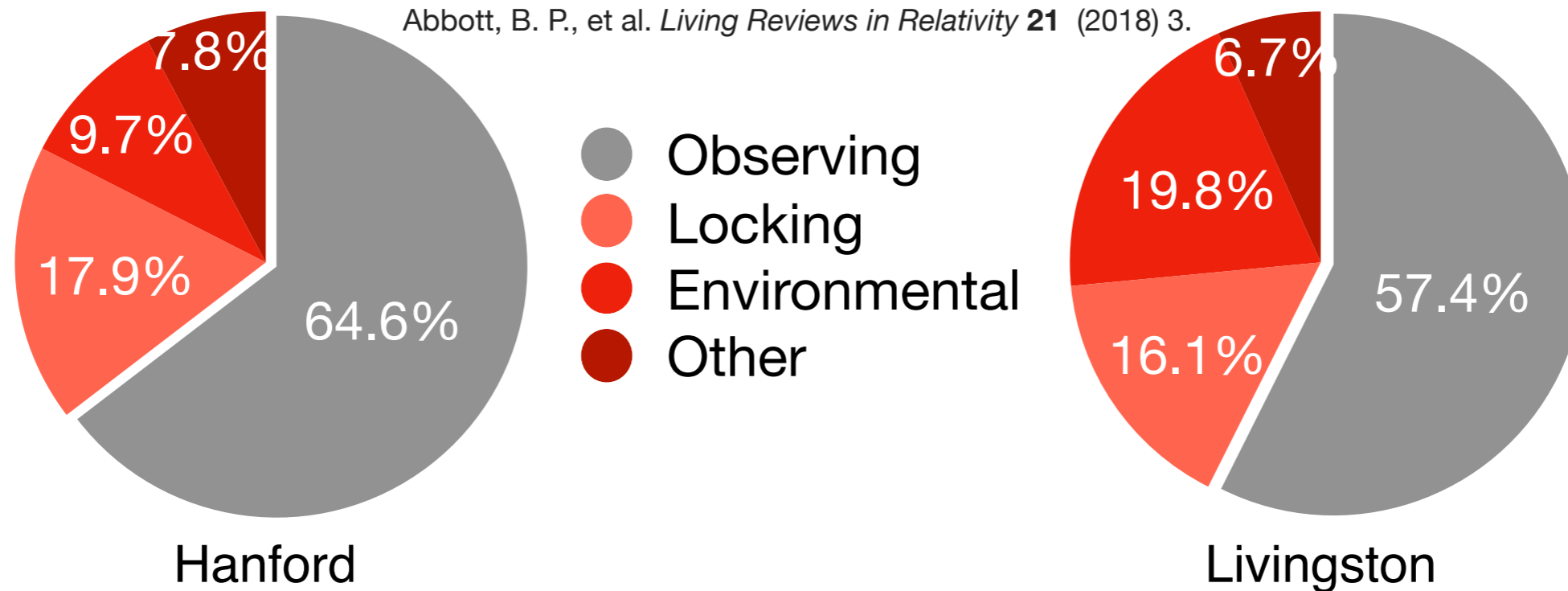

Locking

- transition state toward observation state

Environmental

- **could not lock** due to seismic disturbances.

Other

- commissioning or planned maintenances.

None-observation state

e.g. LIGO detectors during the first observation (O1)

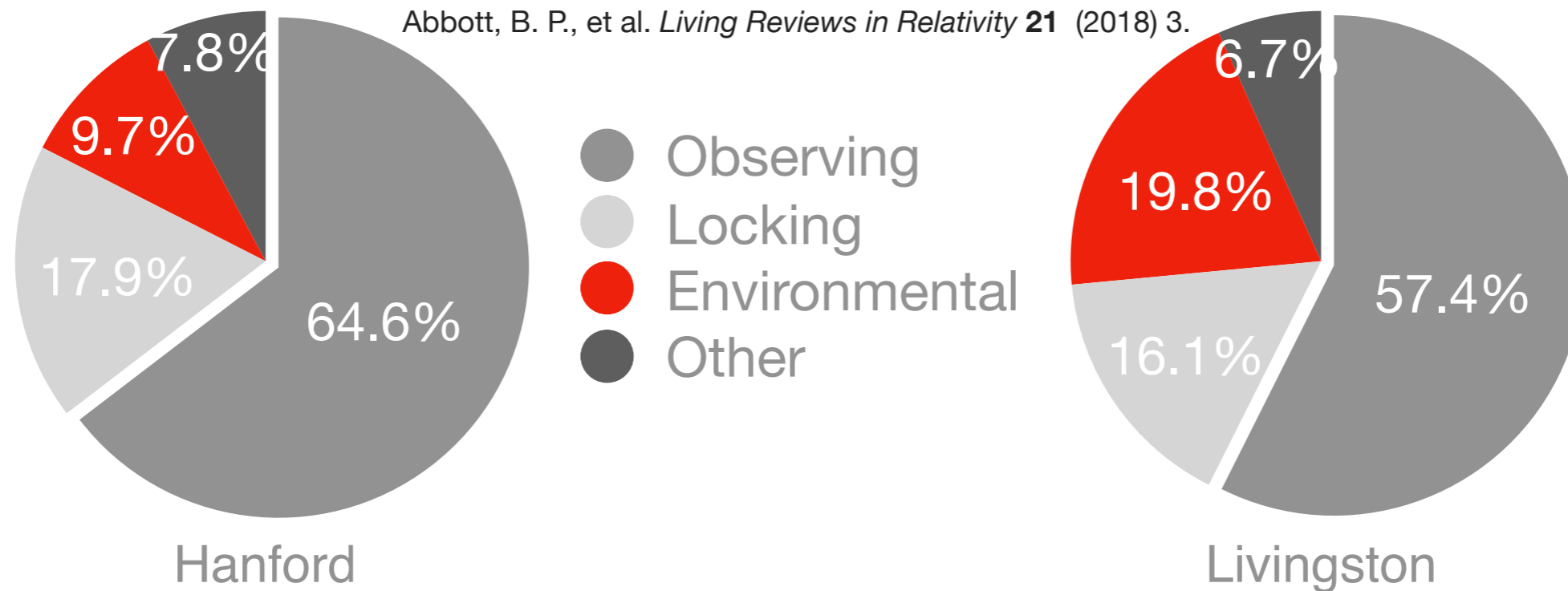

Locking

- transition state toward observation state

Environmental

- could not lock due to seismic disturbances.

We need further improvement of the seismic isolation system.

Environmental disturbances



Seismic noise monitor
in KAGRA control room

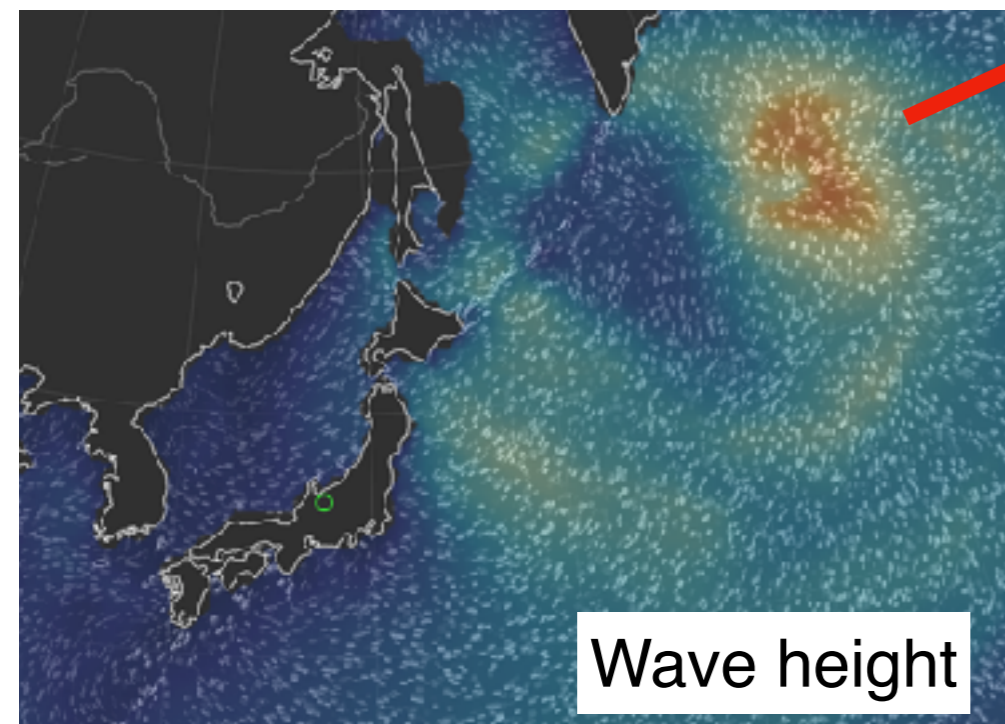
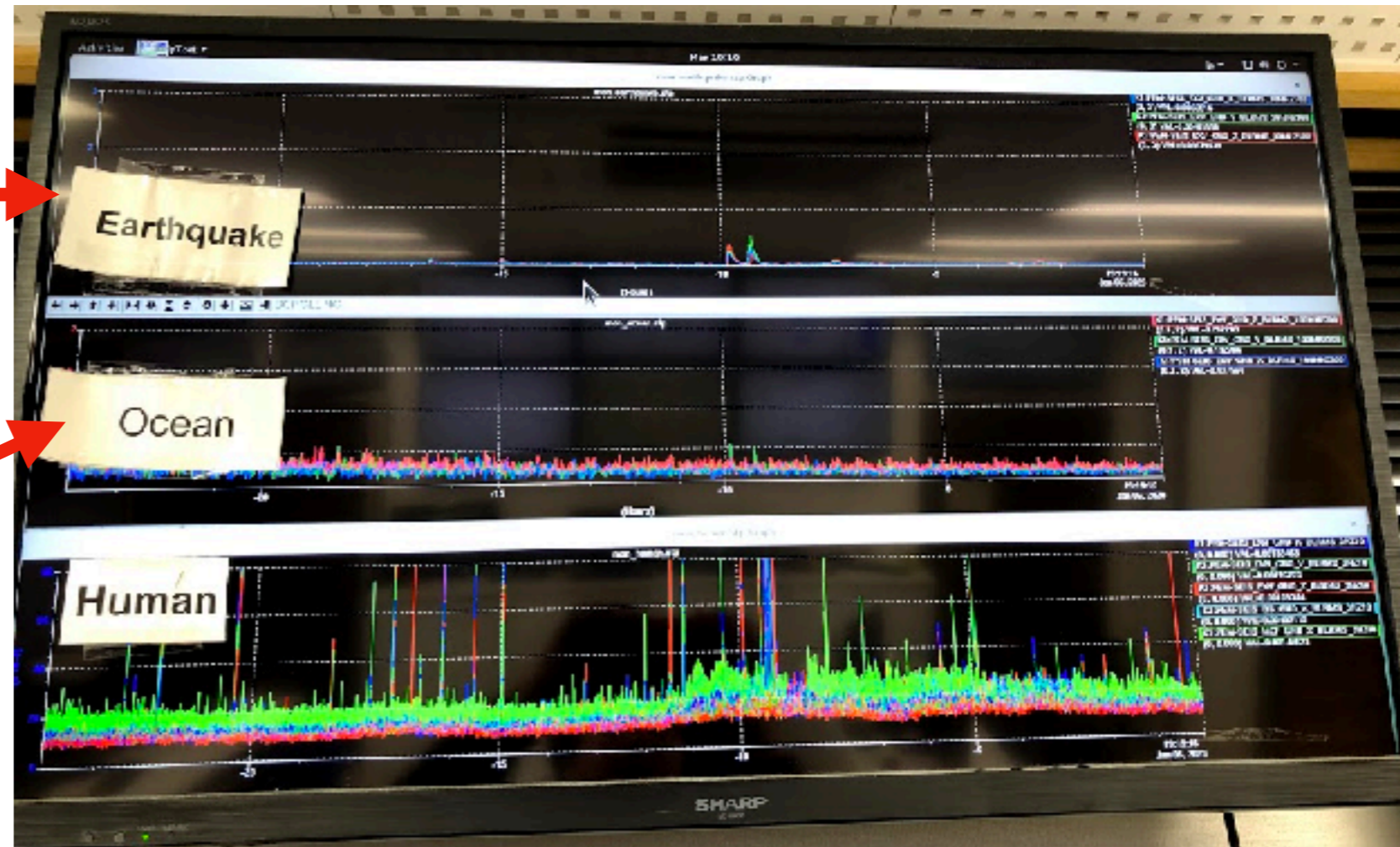

Why GW detectors are weak to seismic disturbances?

Basic design of the **GW detectors** is
Dual-recycled Fabry–Pérot Michelson interferometer

- long arm cavity
- power recycling cavity
- signal recycling cavity

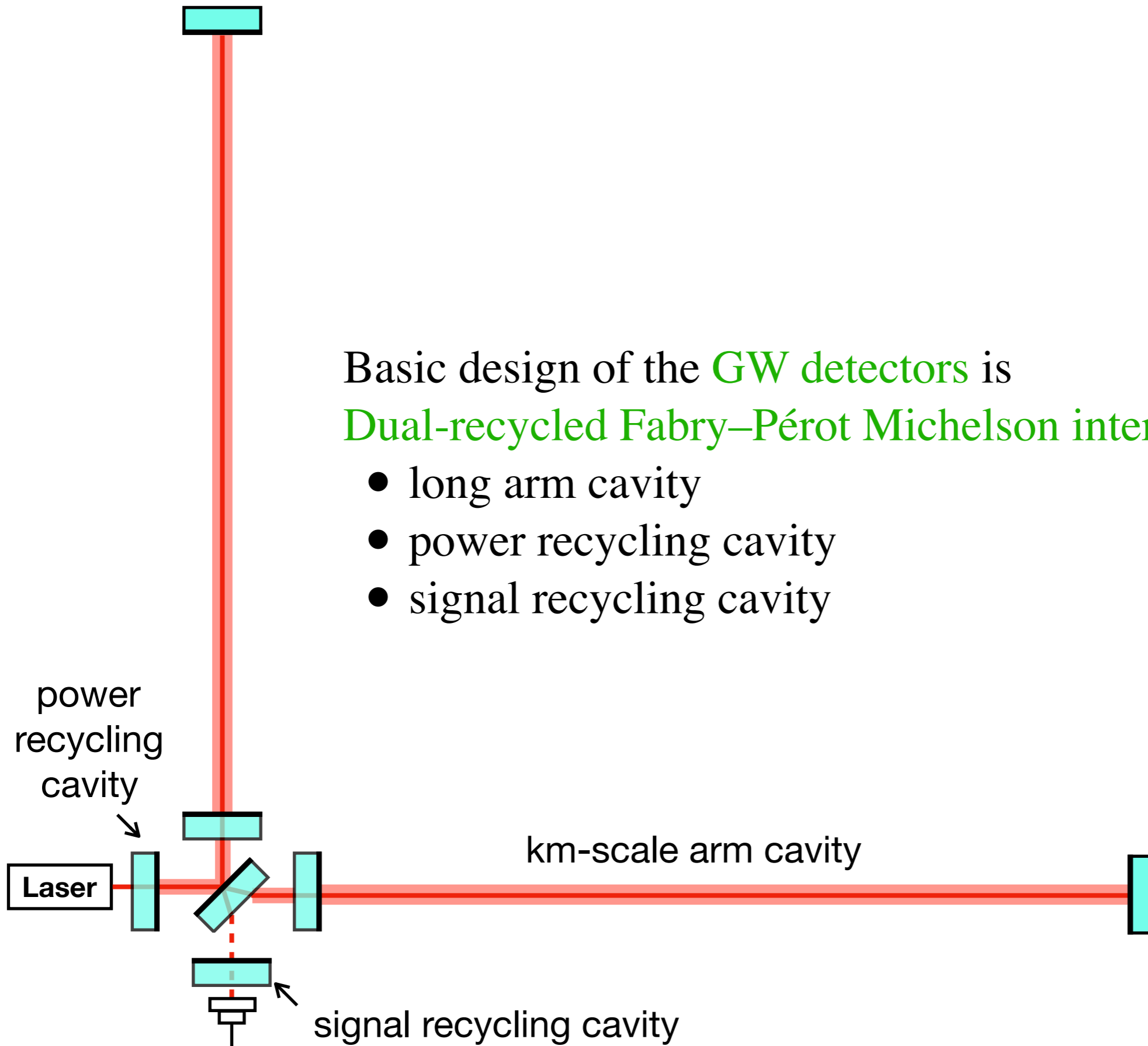

Why GW detectors are weak to seismic disturbances?

Especially, it is most difficult to keep the **arm cavities** on resonance state.

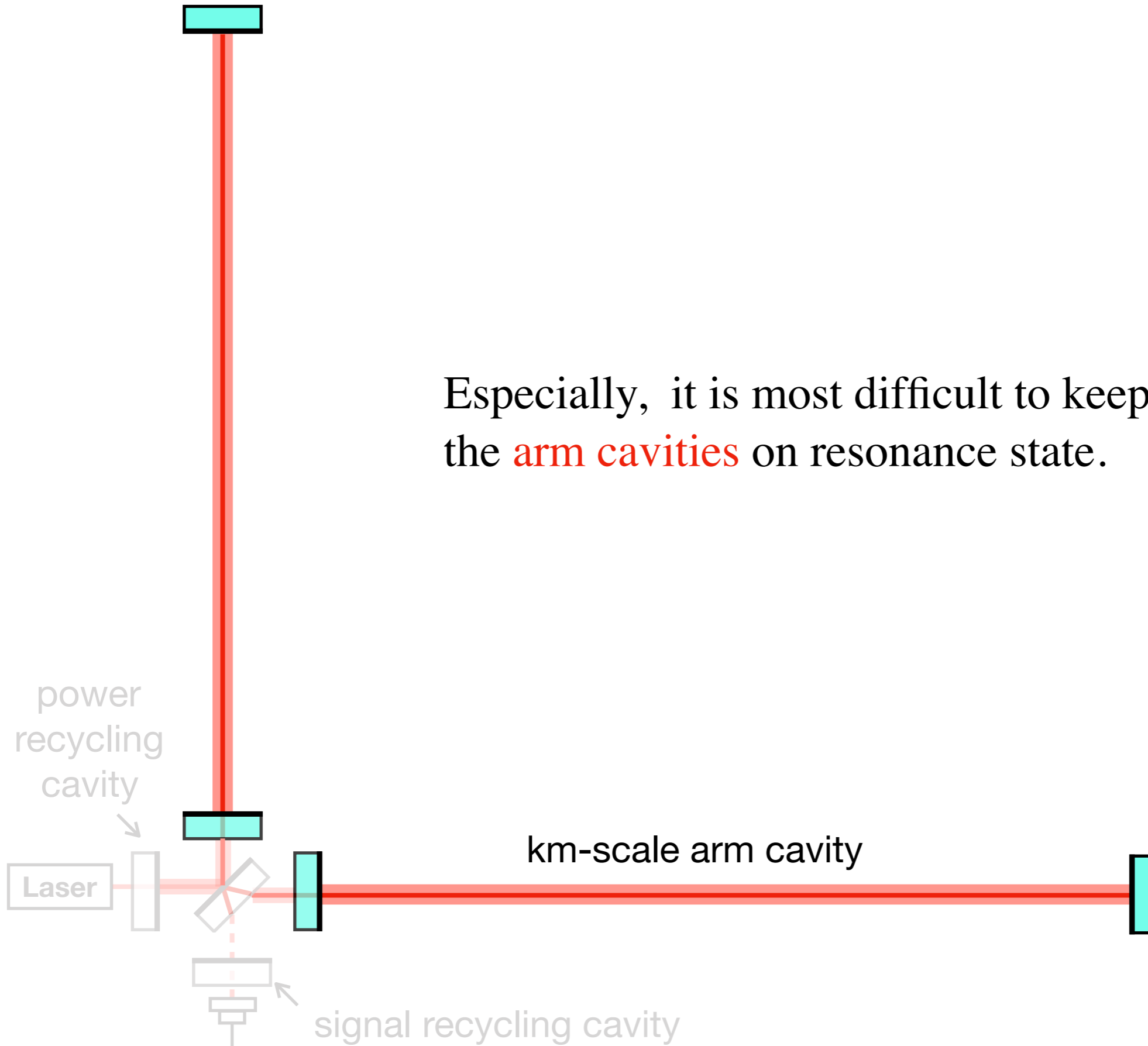

Difficulties in the cavity control

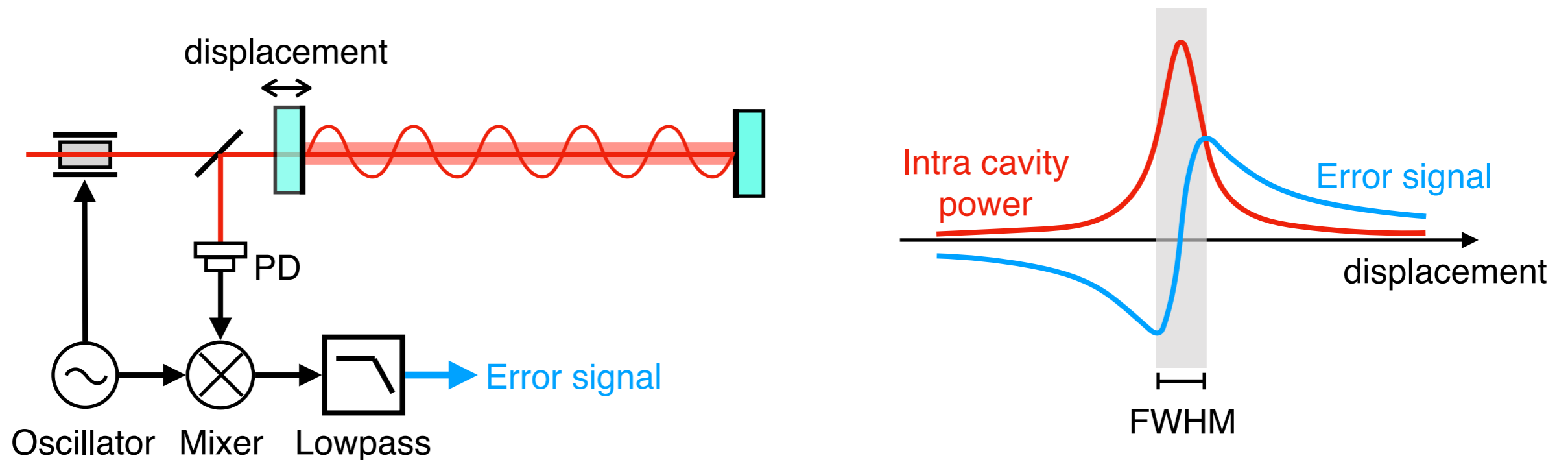

Pound–Drever–Hall (PDH) technique

Resonant condition

- cavity length = $N \times$ wavelength ($N = 1, 2, \dots$)

Controlable condition

- Error signal is linear in FWHM range (\sim nm).



Seismic disturbances should be attenuate within a few nm.

Difficulties in the long cavity

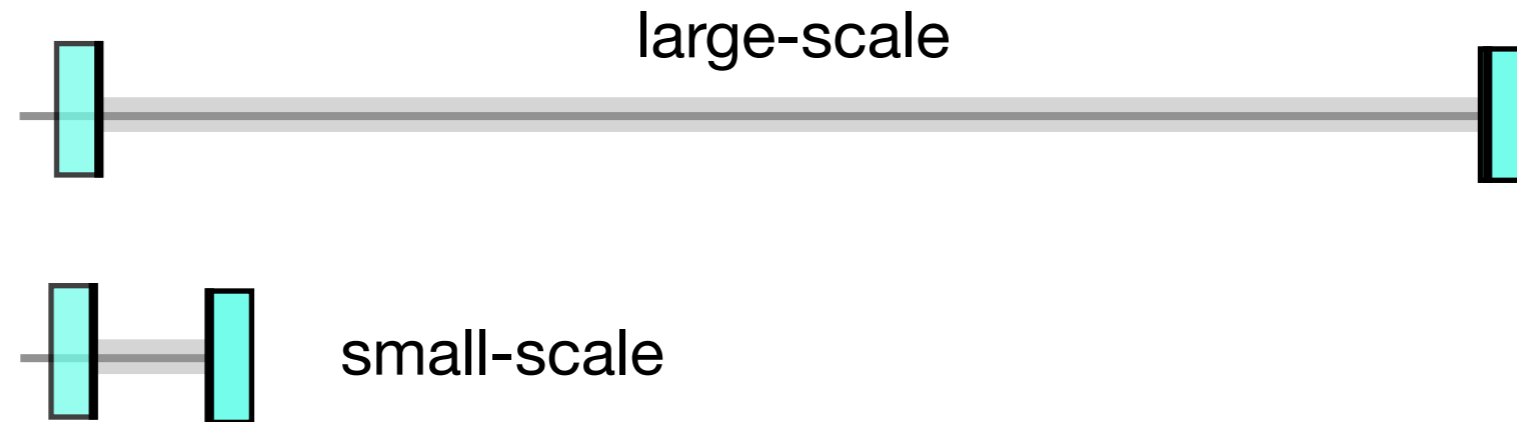

波長の長い低周波地面振動が地面を揺らす場合、

- 短期線だと鏡同士は同相で動くため、長さ変化に現れにくい。
- 長期線になると鏡の動きは無相関に動き、低減効果は薄れる。

つまり、長期線になるほど低周波防振の必要性が増す。

Contents

1. Motivation

- Duty cycle of the GW detectors
- Problems of seismic motion in large-scale GW detectors

2. Review of the previous seismic isolation system

- Seismic isolation for stable operation
- Limit of the current system

3. Baseline Compensation System

- Overview
- Comparison between our system and previous system

4. Demonstration and its results

- Setup for demonstration
- Results

5. Summary

- Conclusion
- Future prospects

Seismic Noise

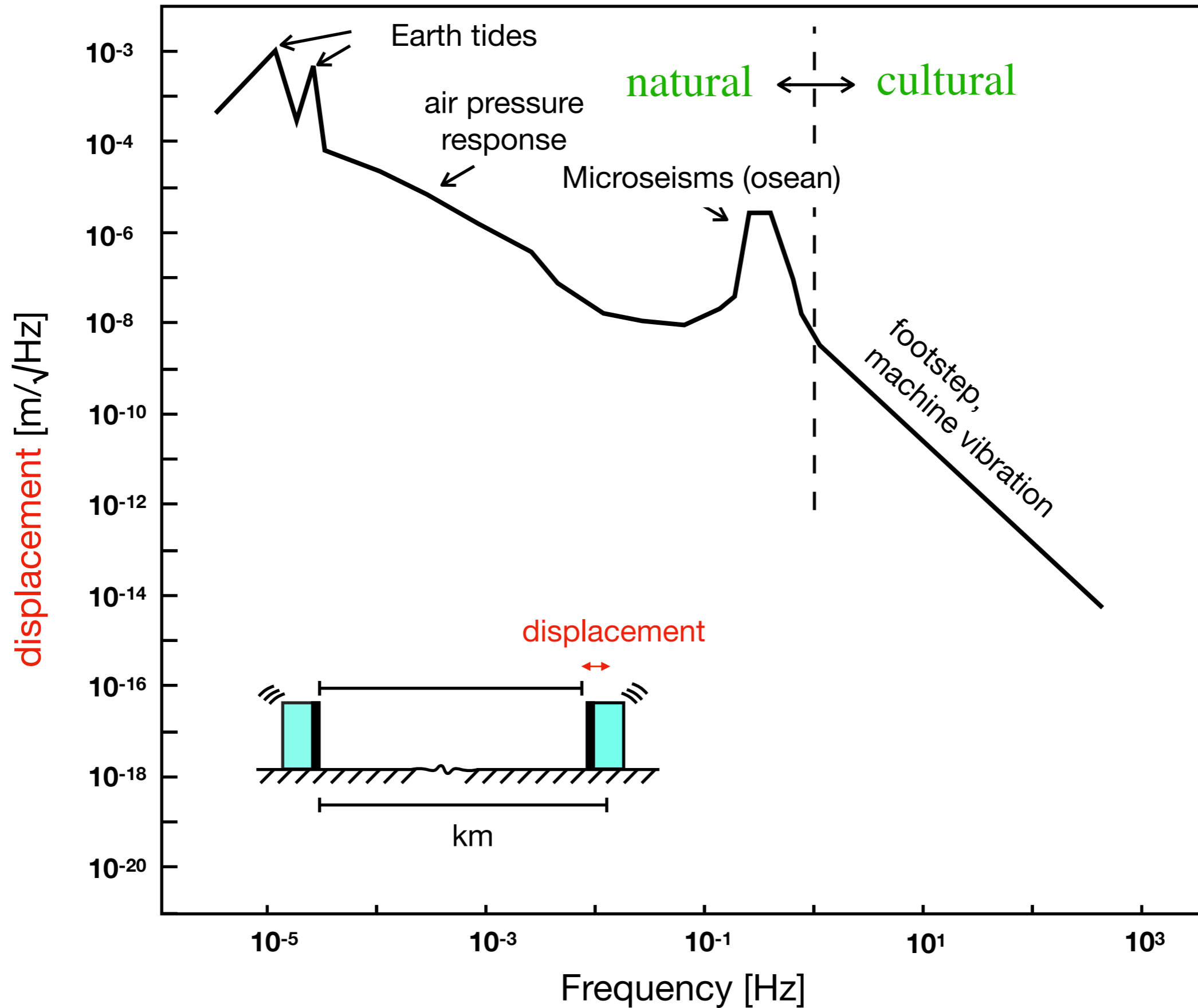

Seismic Noise

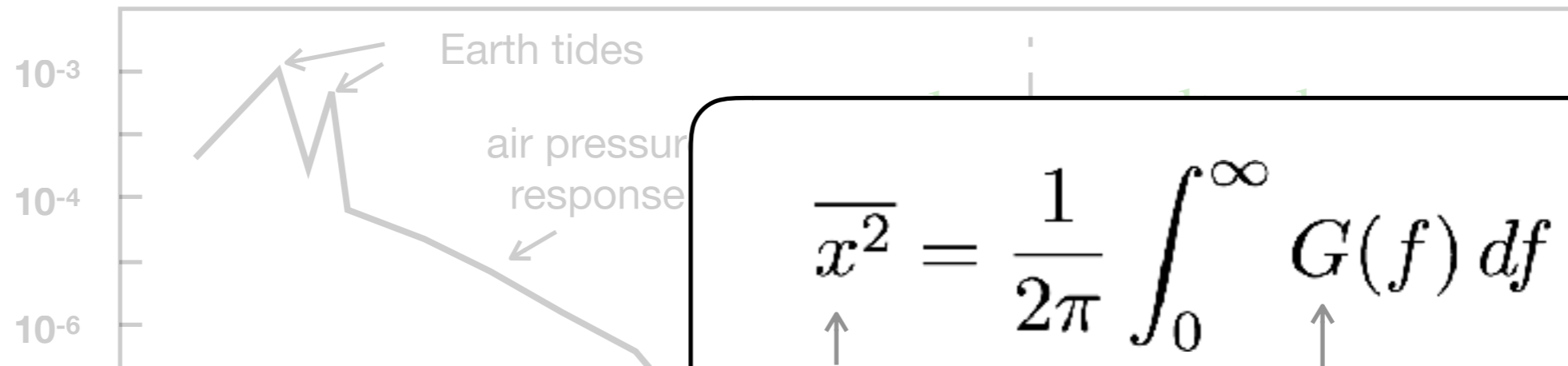

Amplitude Spectrum Density

[m/√Hz]

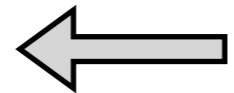

√
Square

$$\overline{x^2} = \frac{1}{2\pi} \int_0^\infty G(f) df$$

↑ (RMS)² ↑ Power Spectrum Density

[m²] [m²/Hz]

displacement

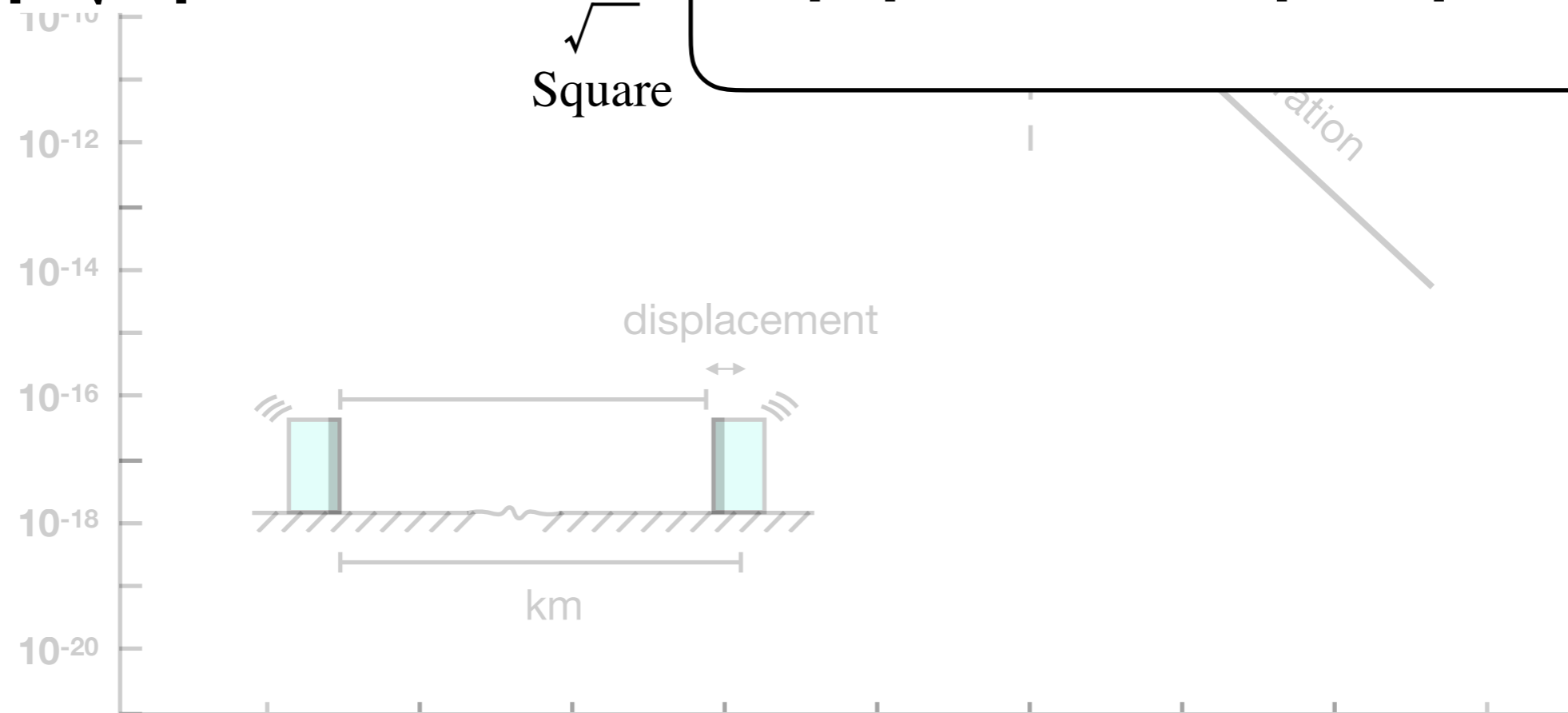

10⁻⁵ 10⁻³ 10⁻¹ 10¹ 10³

Frequency [Hz]

Seismic Noise

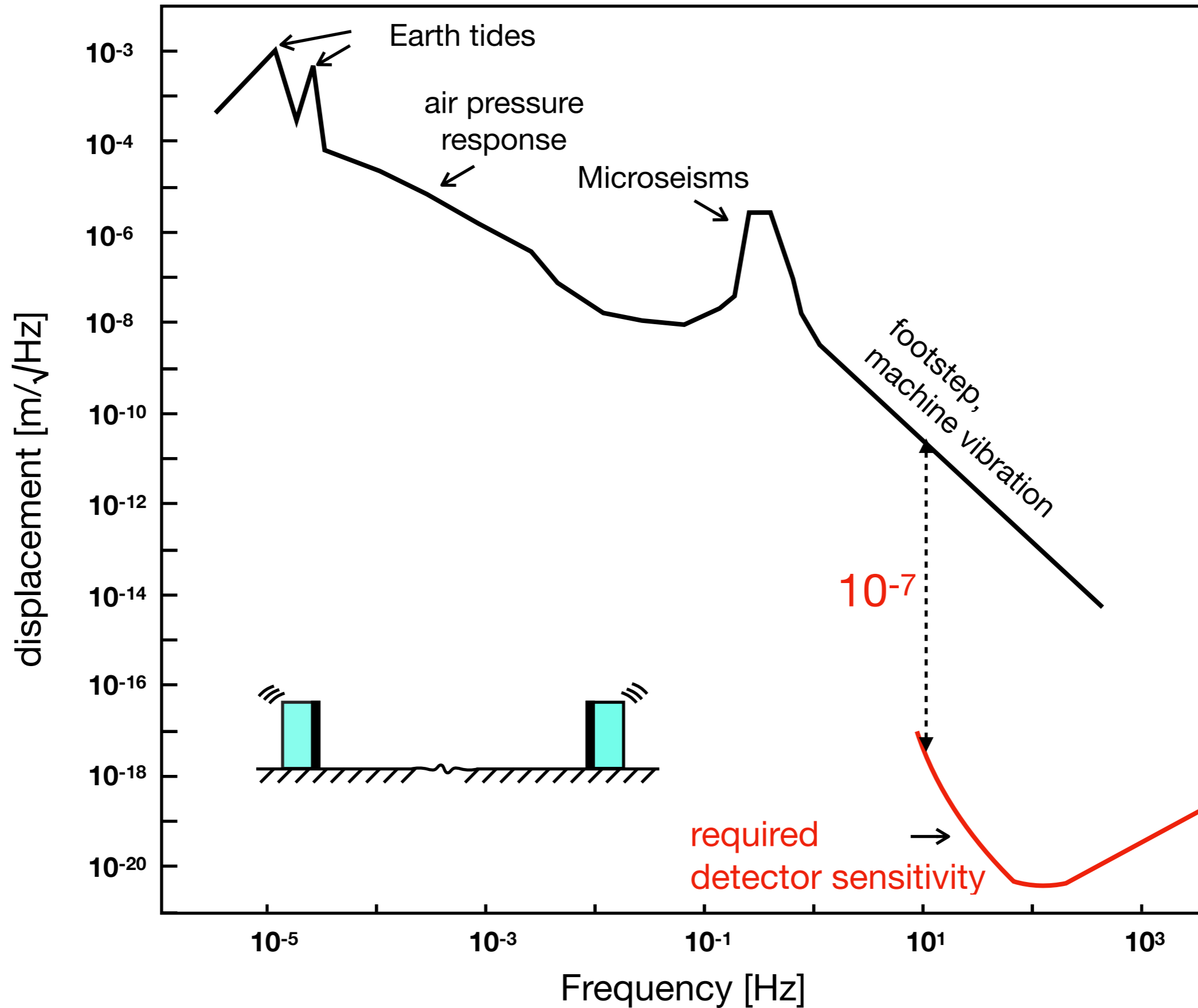

Review : seismic isolation system

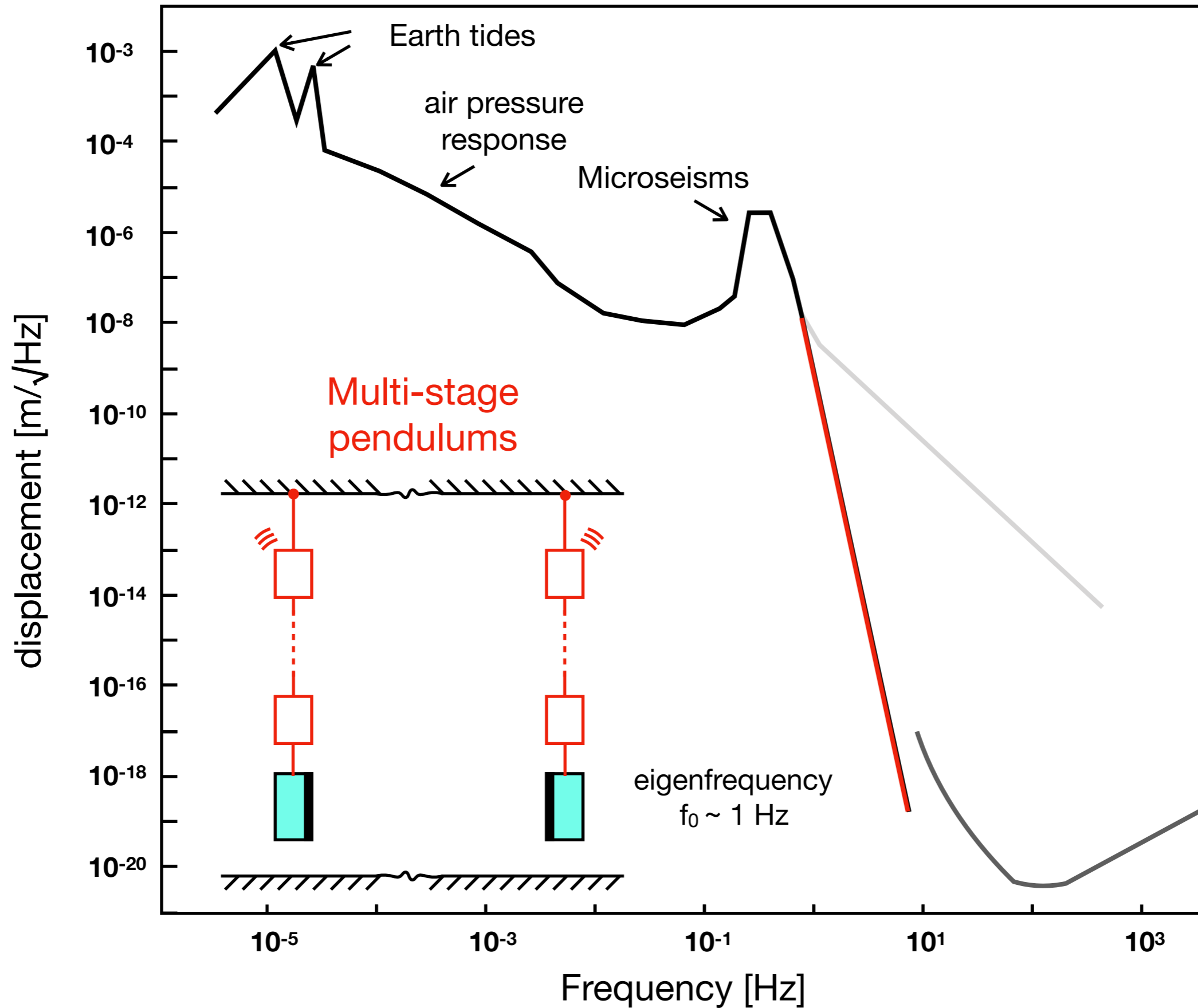

Review : seismic isolation system

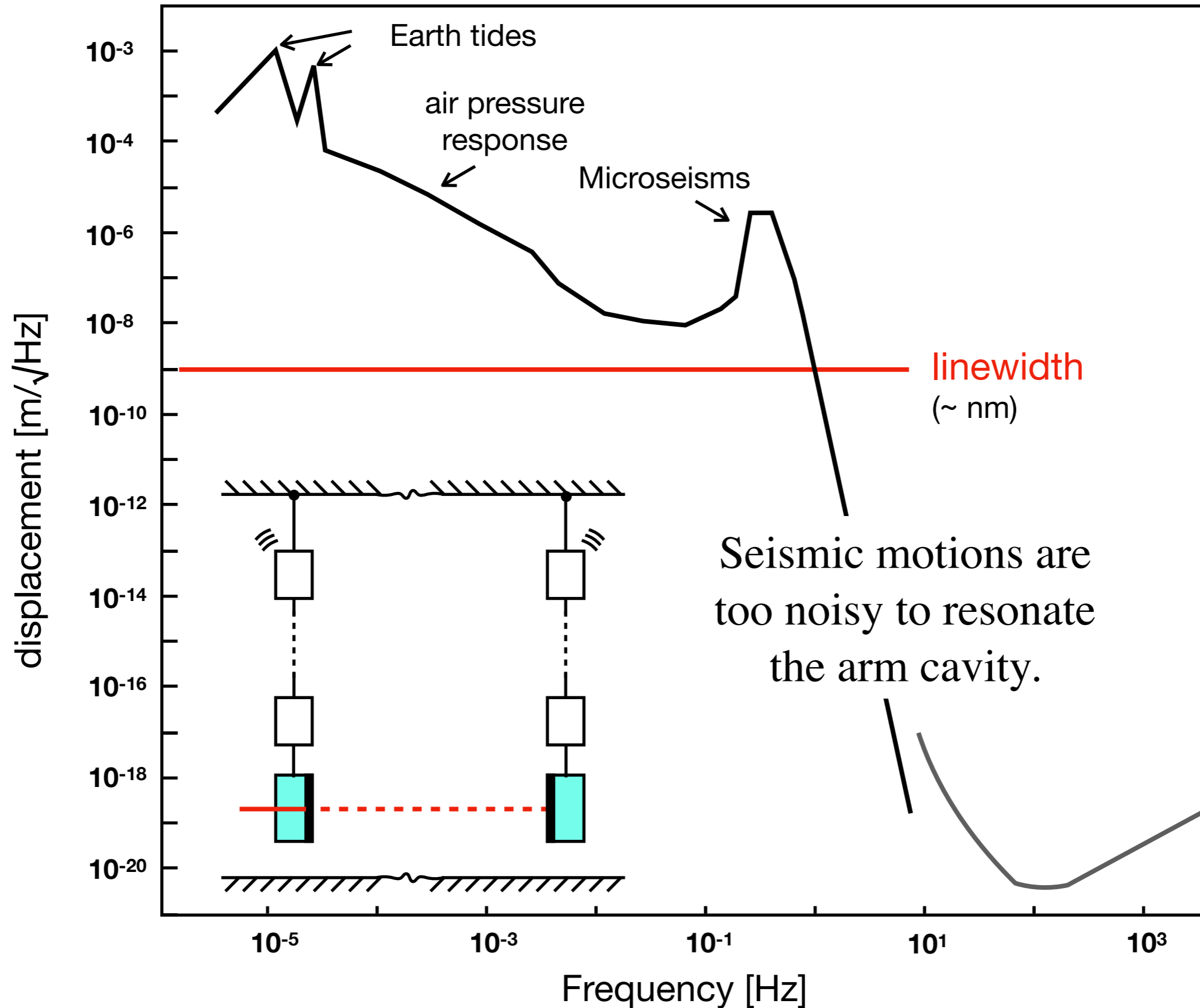

Review : seismic isolation system

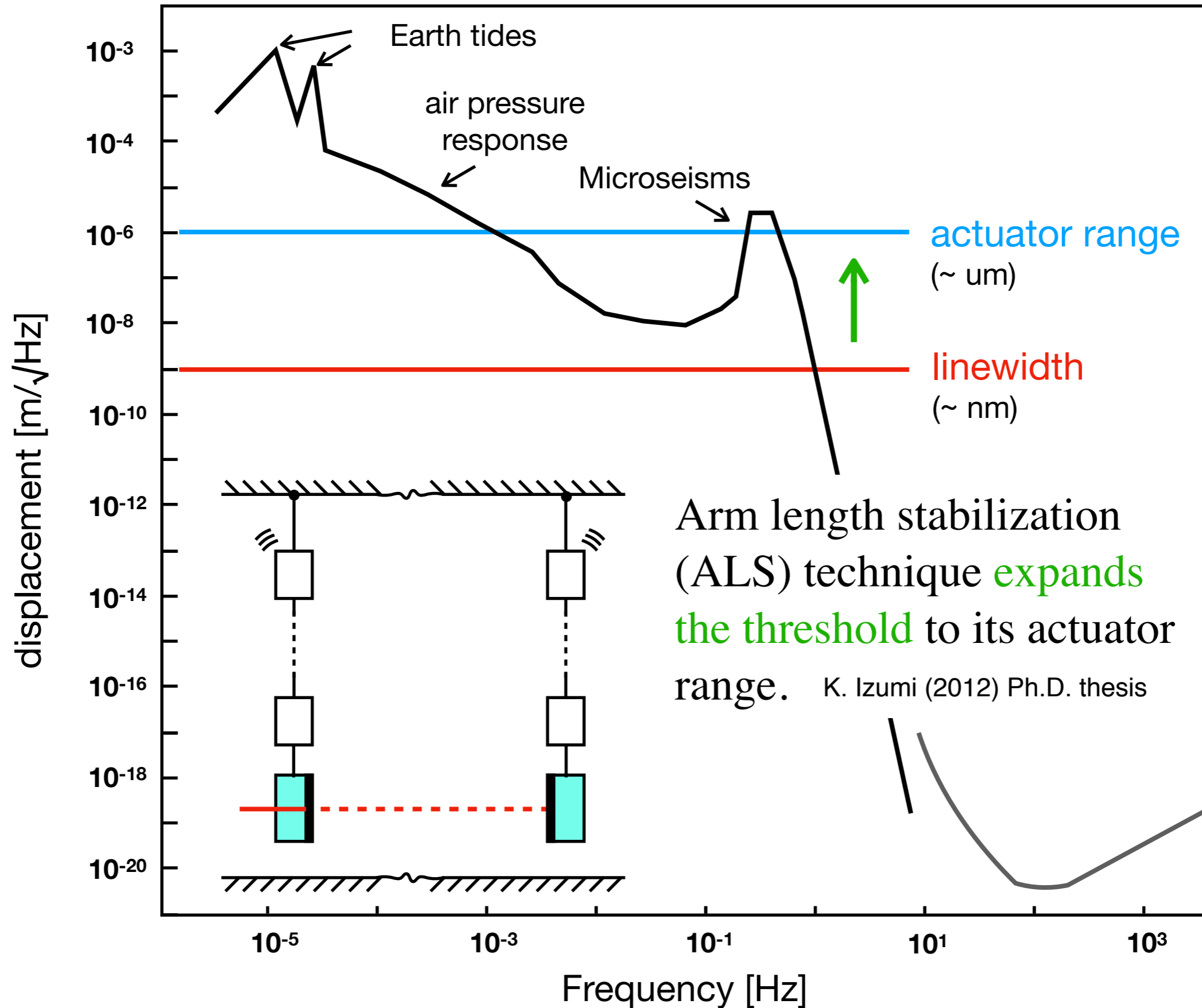

Review : seismic isolation system

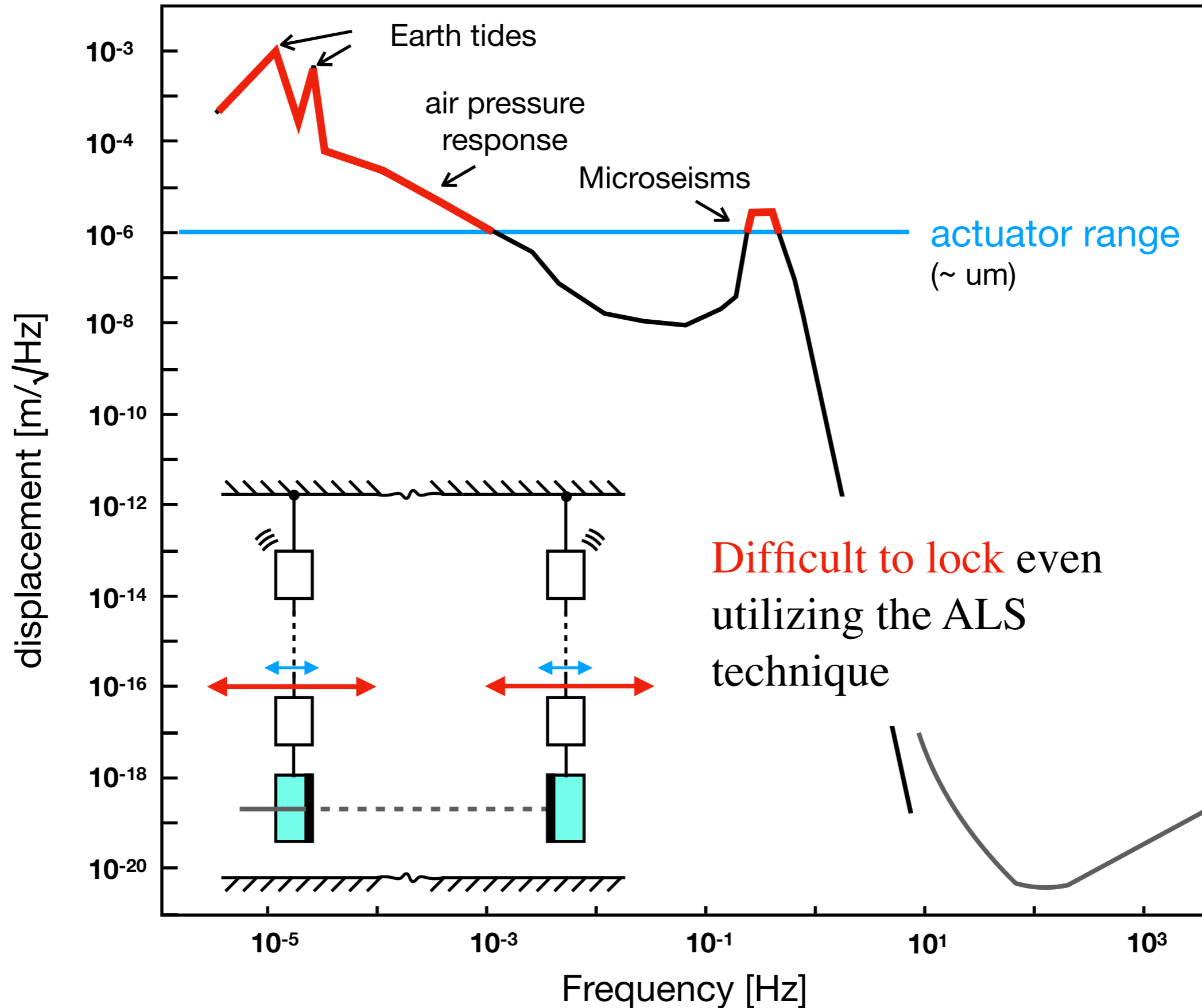

Review : seismic isolation system

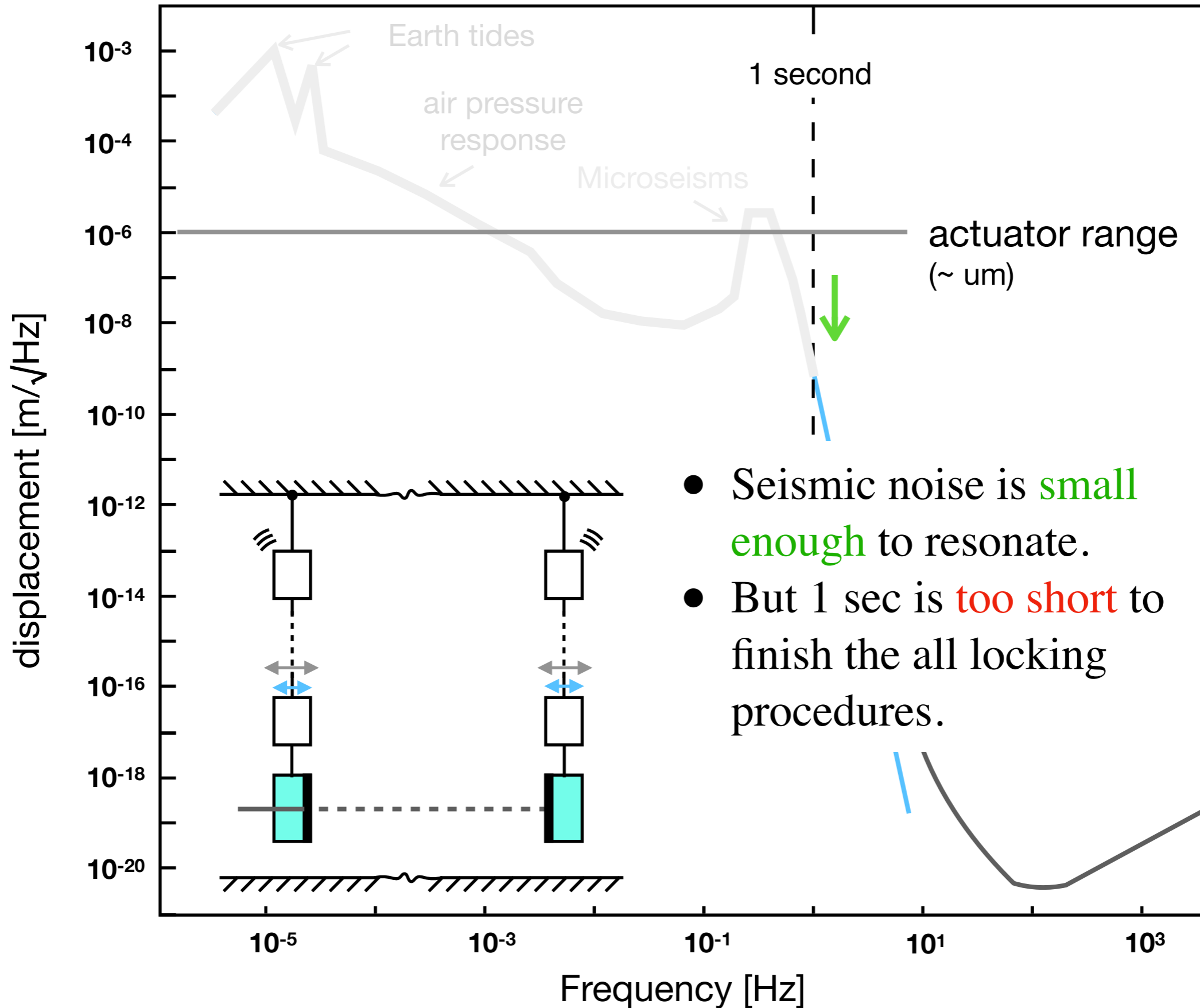

Review : seismic isolation system

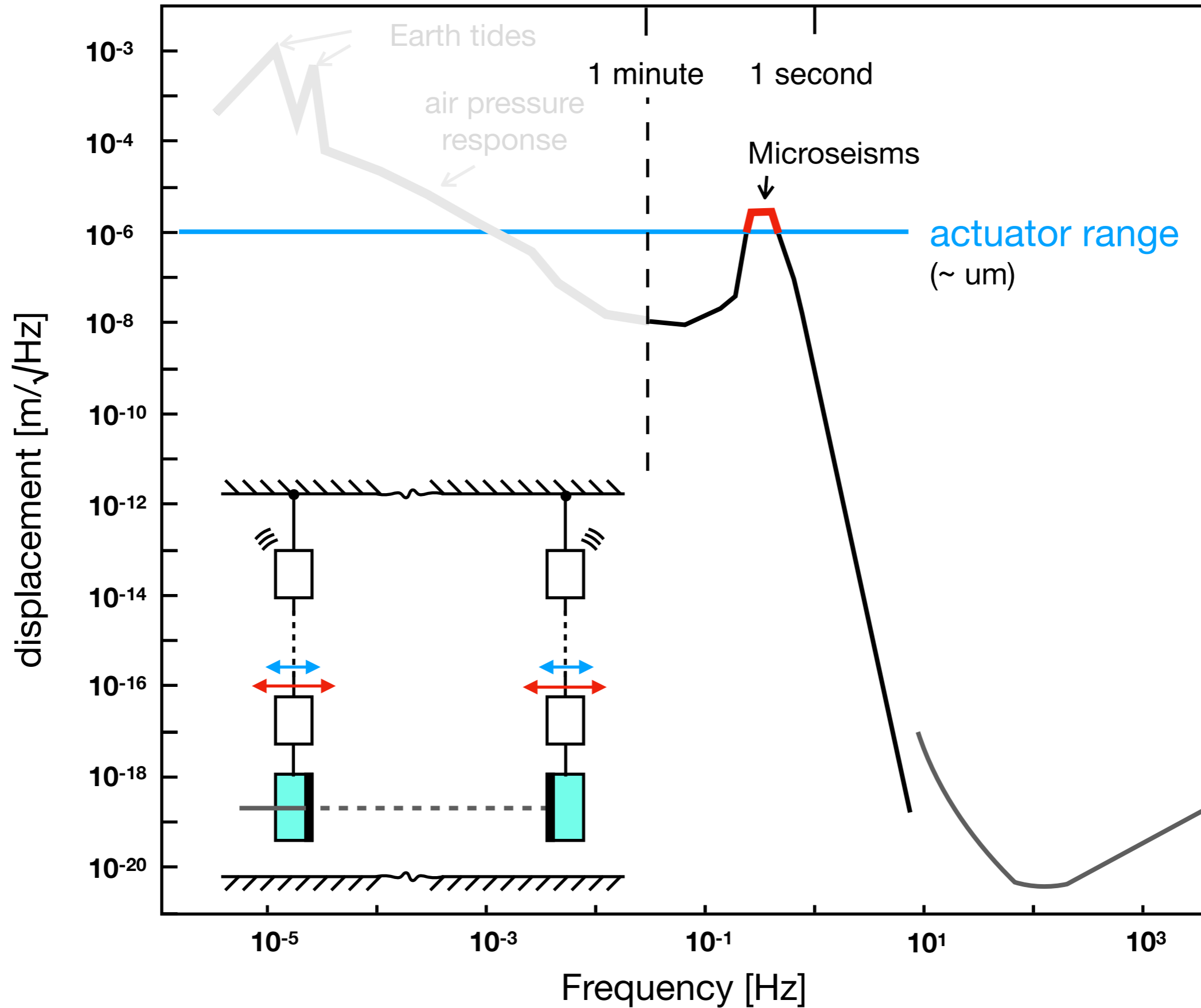

Review : seismic isolation system

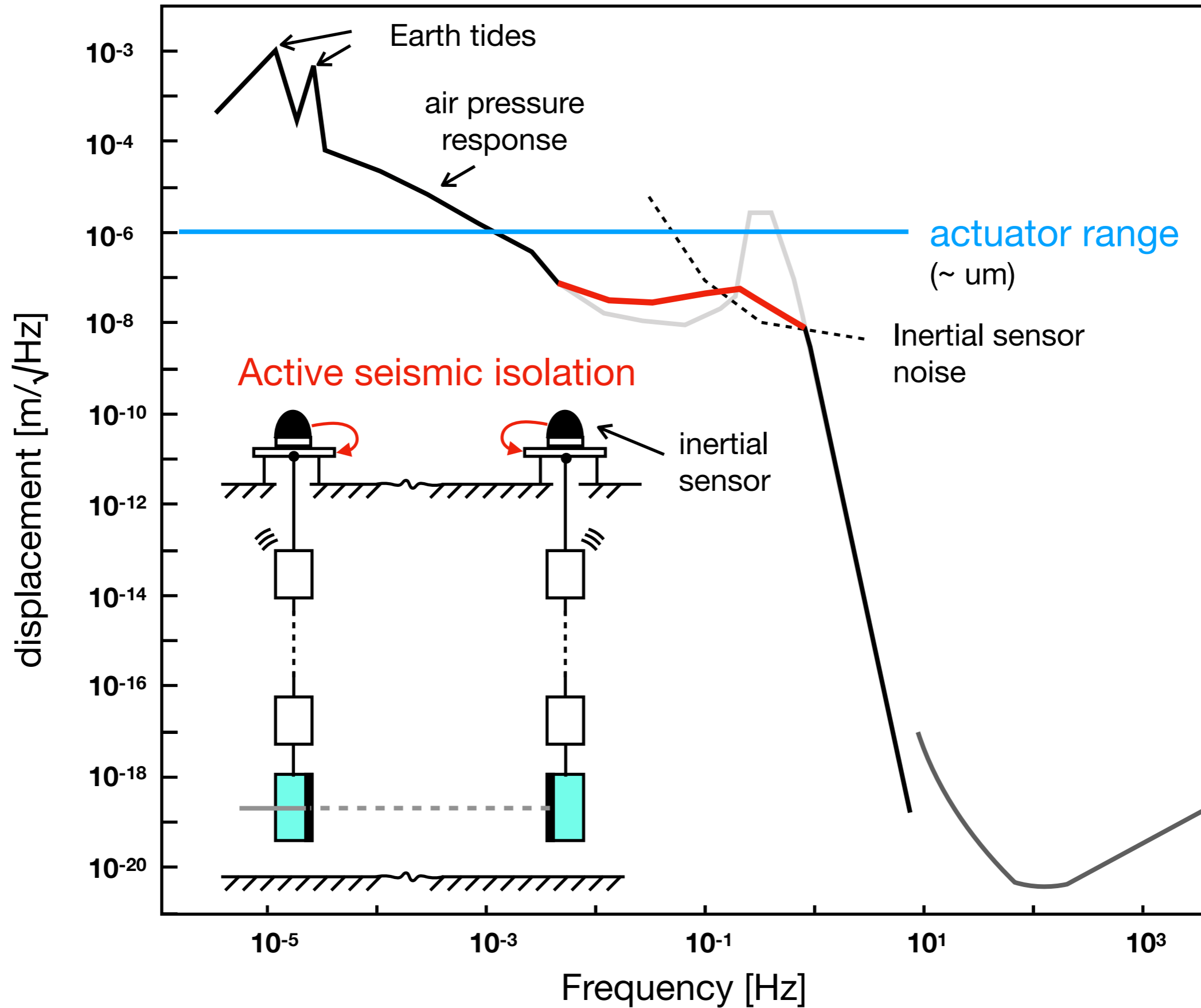

Review : seismic isolation system

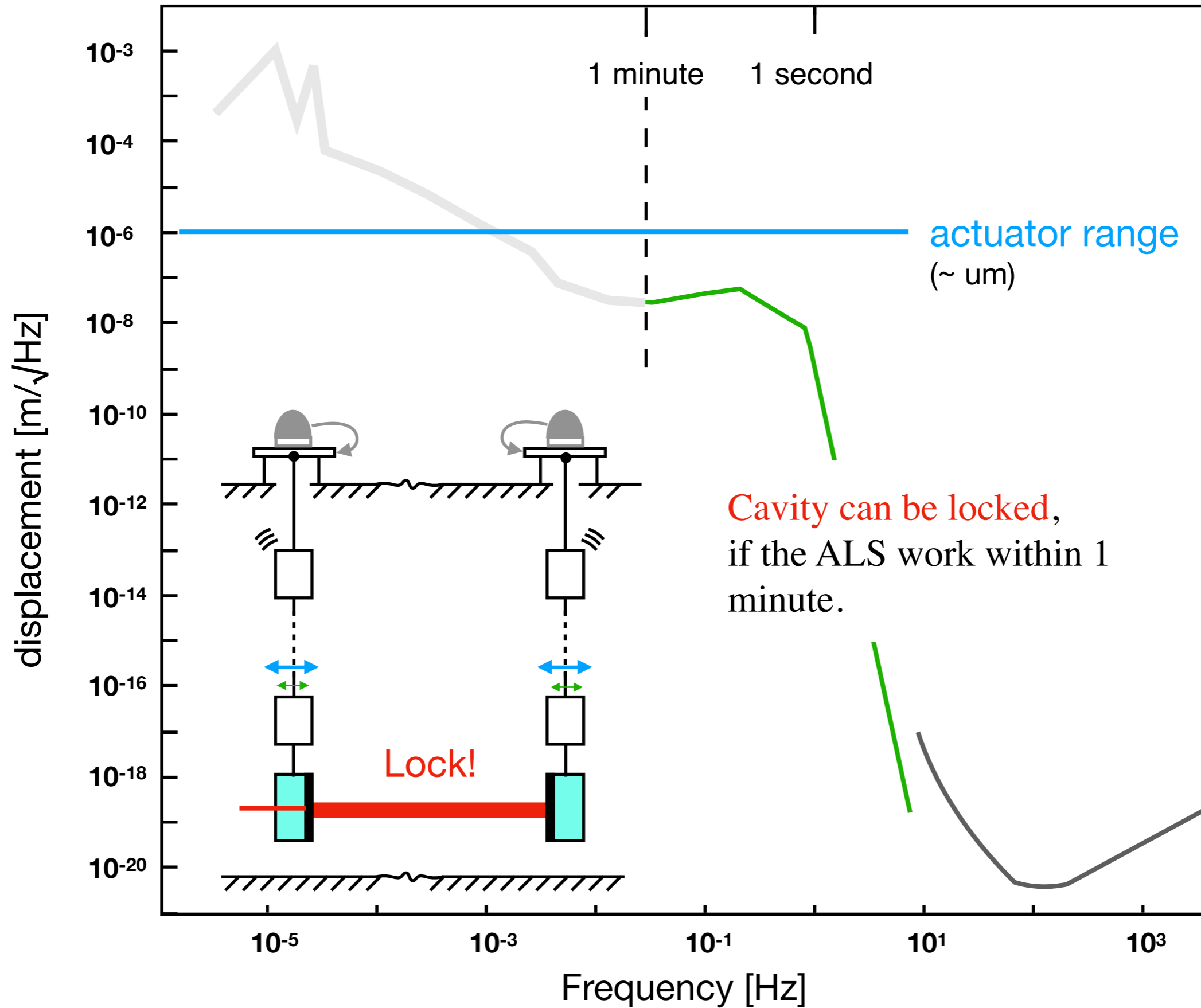

Review : seismic isolation system

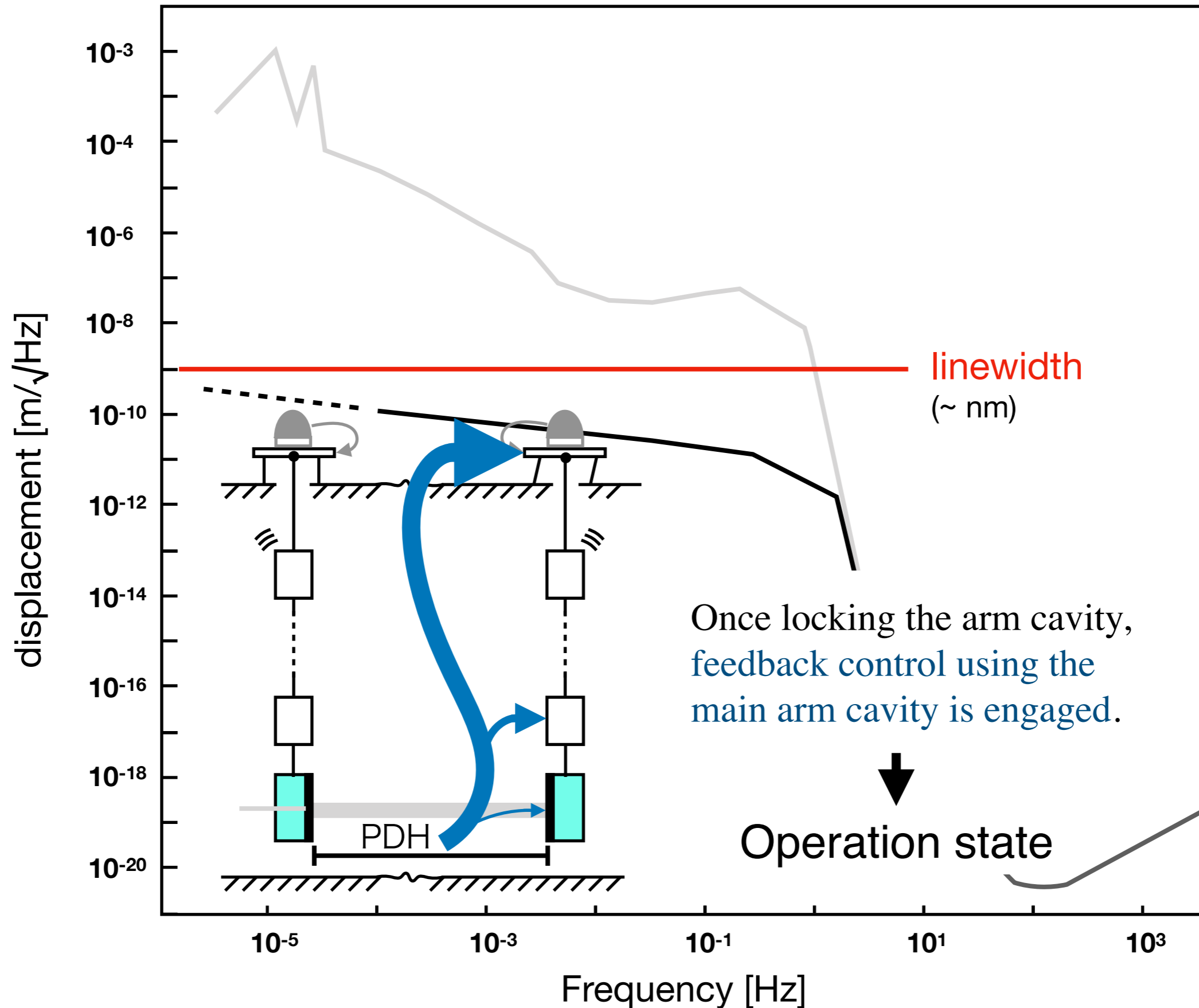

Current seismic isolation system seems fine, but...

Limit has become apparent [*]

- **Suspension is weak** to seismic disturbance below 100 mHz due to the **inertial sensor's noise**.
- Earthquake often shakes this band.
- Once lost locking state, it takes **several hours to recover**.

My study resolves this sensor noise problem.

- **LIGO** is optimizing the control filter in the software because of **no better sensitive sensor**.
- **KAGRA** resolves this problem by using **a laser strainmeter** directly.

[*] Biscans, Sebastien, et al.

"Control strategy to limit duty cycle impact of earthquakes on the LIGO gravitational-wave detectors."

CQG 35.5 (2018): 055004.

Contents

1. Motivation

- Duty cycle of the GW detectors
- Problems of seismic motion in large-scale GW detectors

2. Review of the previous seismic isolation system

- Seismic isolation for stable operation
- Limit of the current system

3. Baseline Compensation System

- Overview
- Comparison between our system and previous system

4. Demonstration and its results

- Setup for demonstration
- Results

5. Summary

- Conclusion
- Future prospects

KAGRA and strainmeter

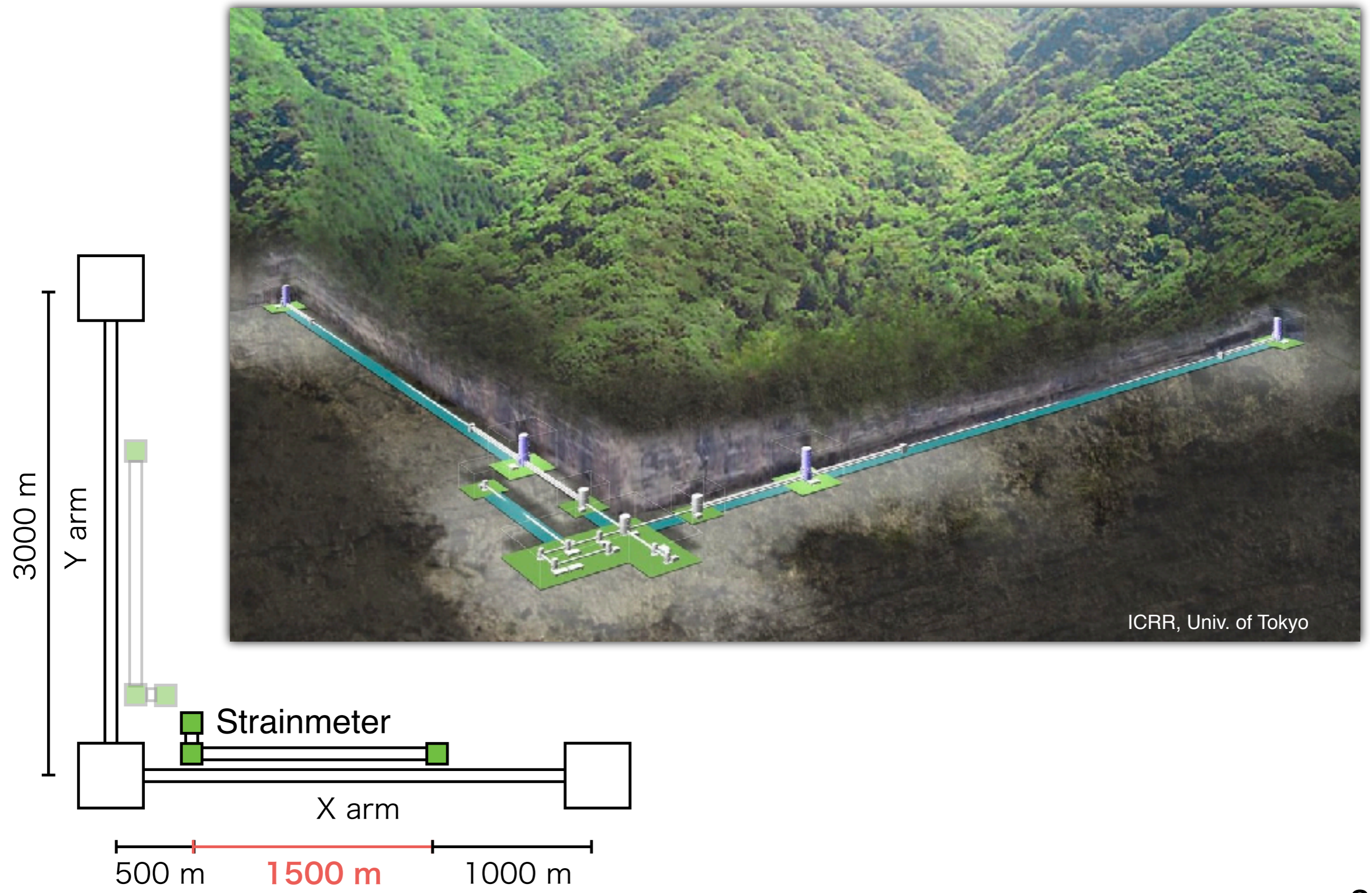

Baseline Compensation System

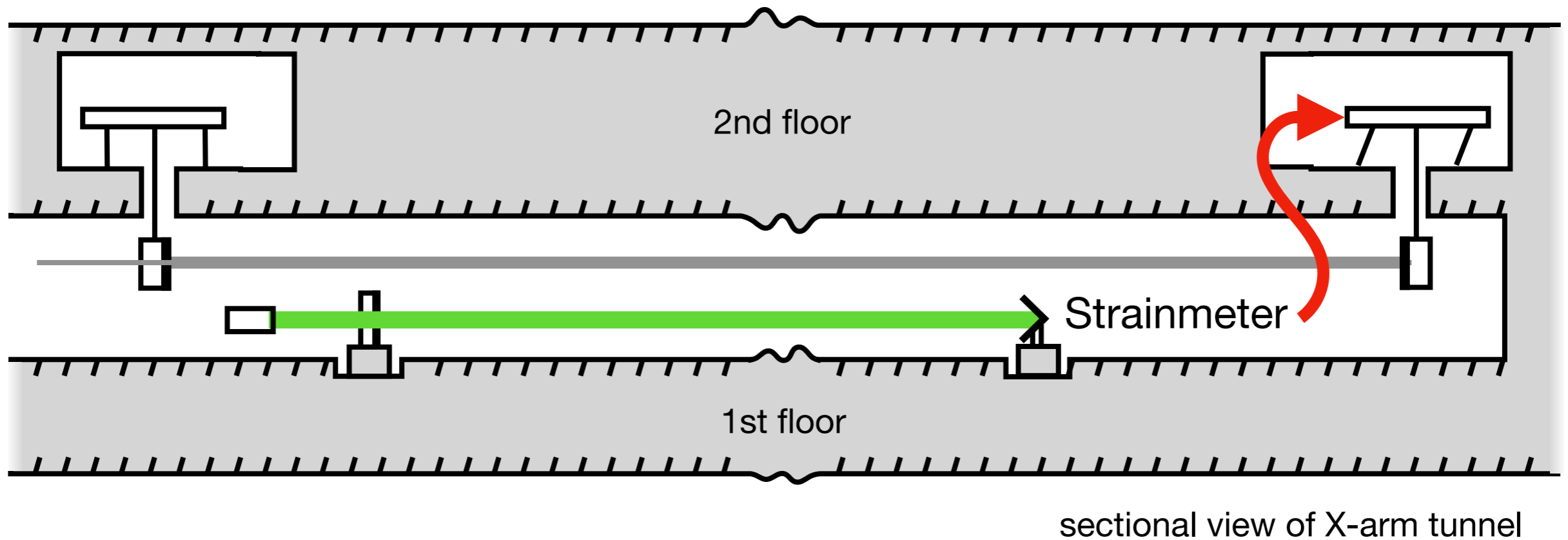

Feedforward control using a strainmeter

- compensate for the cavity length by actuating the top stage

Comparison between seismometer and strainmeter

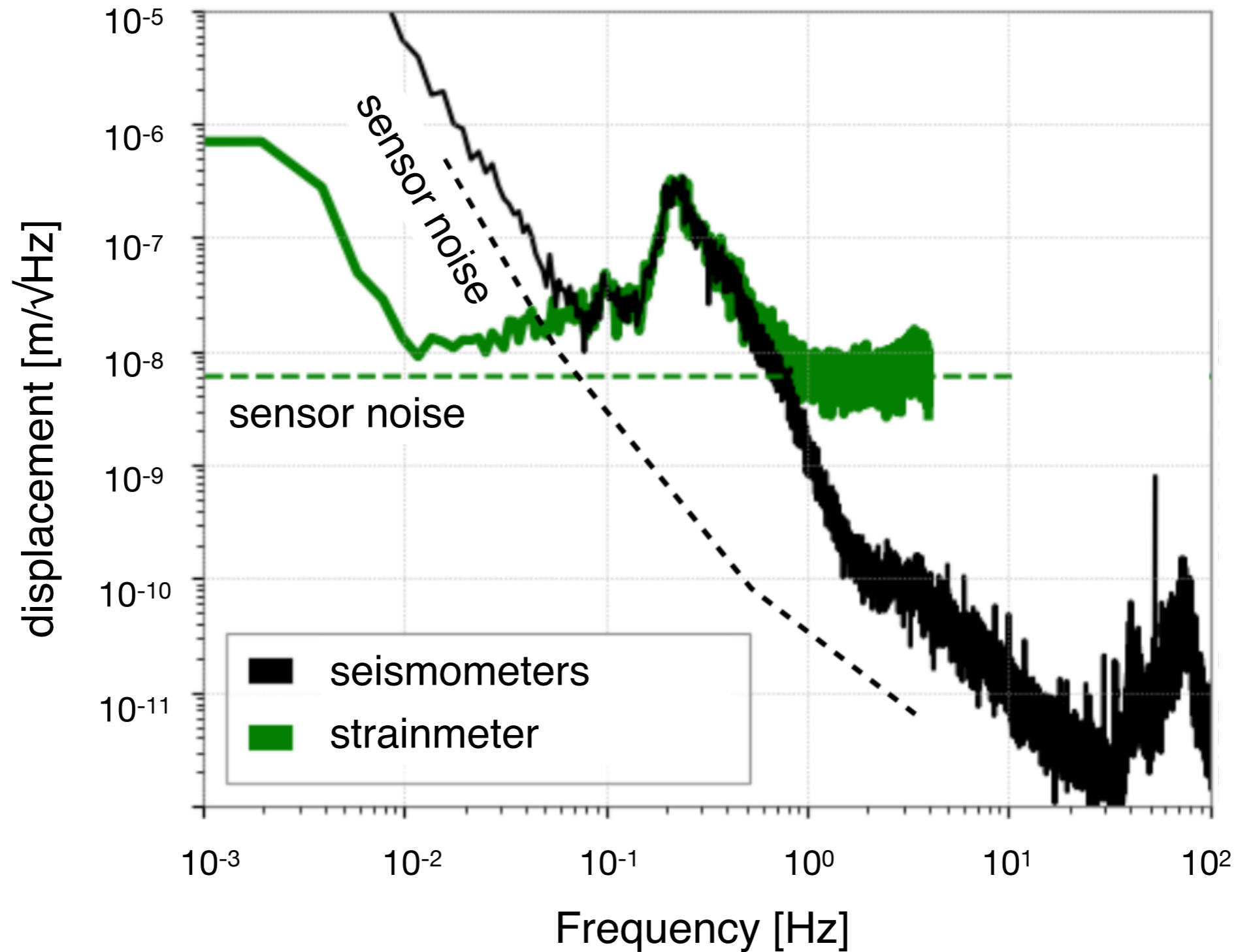

Strainmeter has a better sensitivity below 0.1 Hz

Advantage of our system

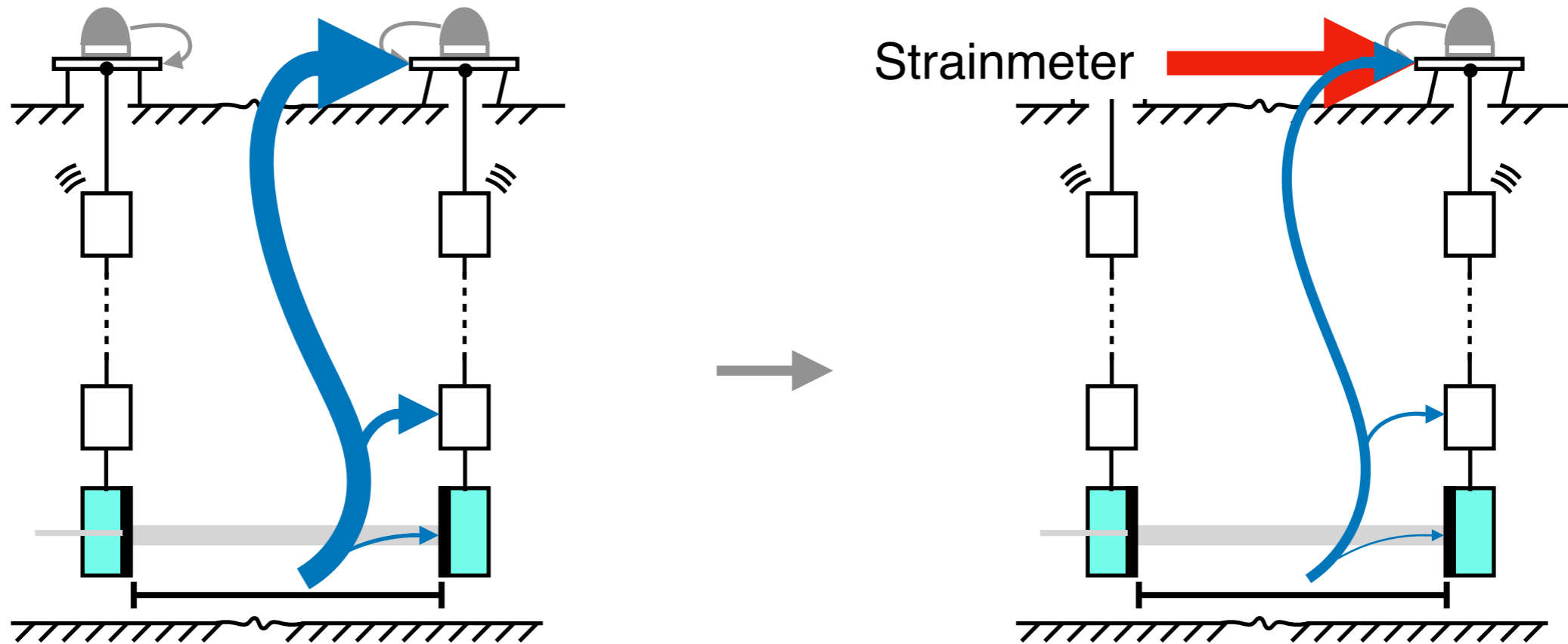

Relax the feedback control

- reduce loads of the actuation forces on lower-stage
 - avoid the saturation of the actuation force
- **More stable operation**

Contents

1. Motivation

- Duty cycle of the GW detectors
- Problems of seismic motion in large-scale GW detectors

2. Review of the previous seismic isolation system

- Seismic isolation for stable operation
- Limit of the current system

3. Baseline Compensation System

- Overview
- Comparison between our system and previous system

4. Demonstration and its results

- Setup for demonstration
- Results

5. Summary

- Conclusion
- Future prospects

Setup for Demonstration

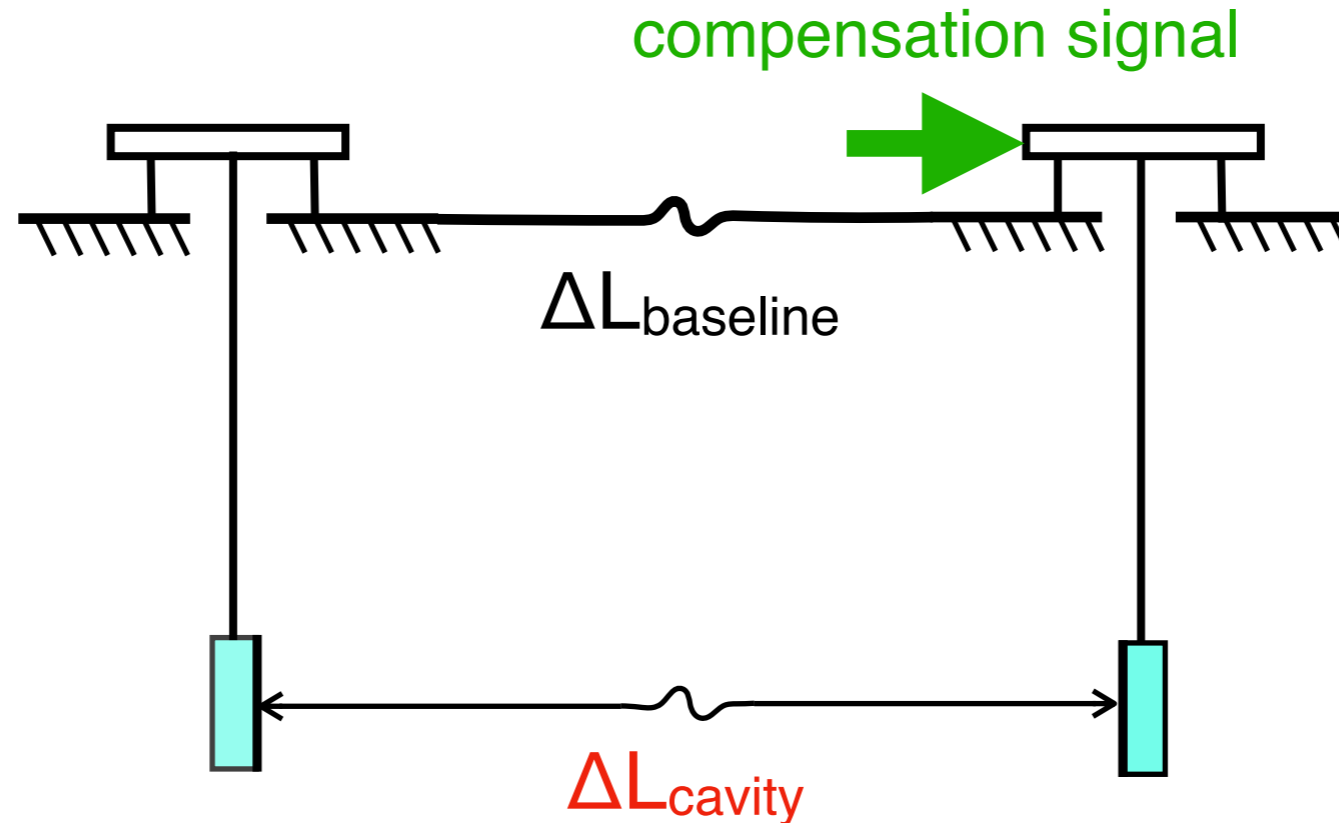

Purpose is to demonstrate the **reduction of the cavity length fluctuation** when using the **baseline compensation system**

Setup for Demonstration

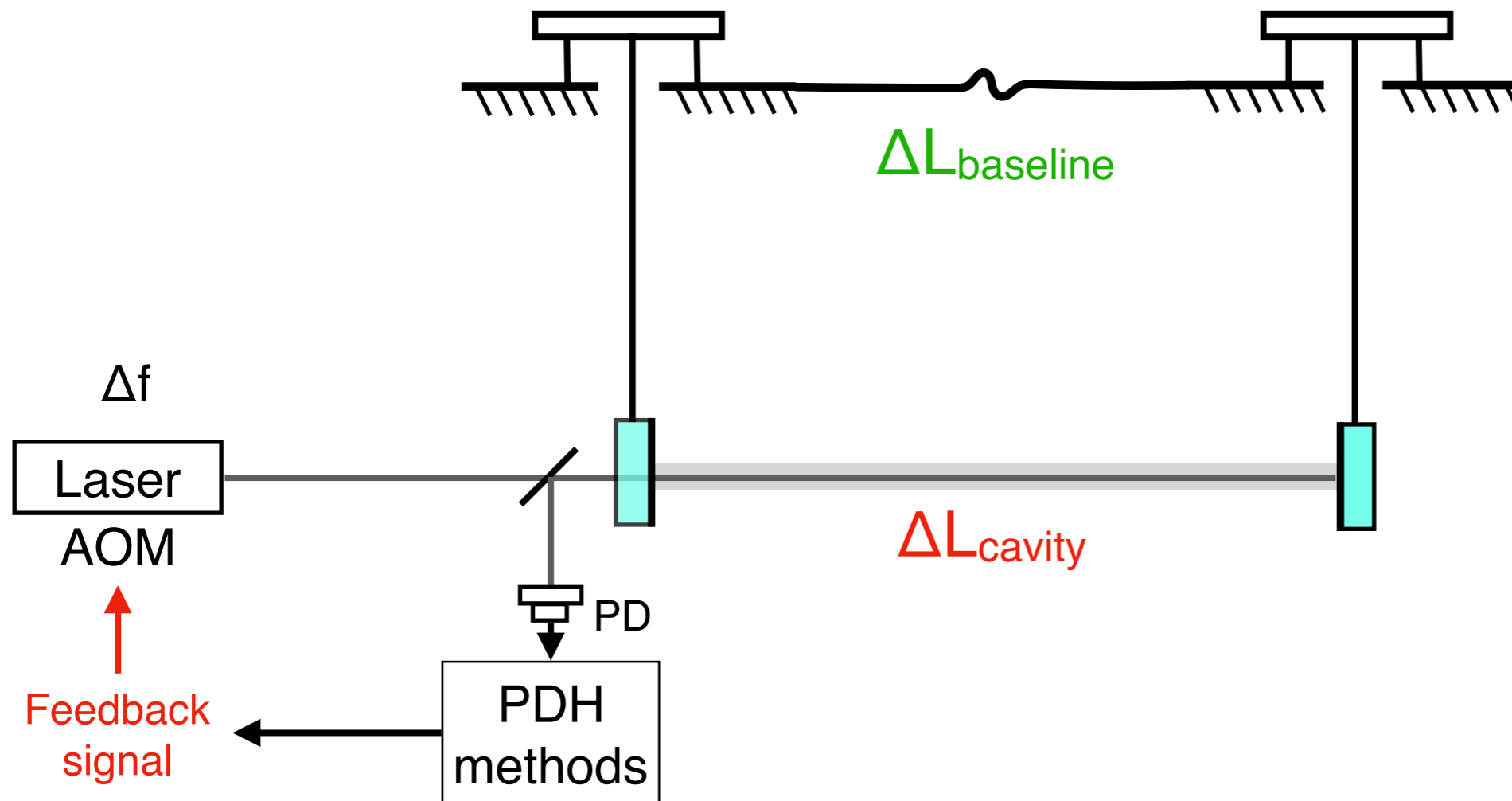

- Keep the X-arm cavity on resonance by feedback control using AOM as a frequency actuator.
- **Baseline length fluctuation** ΔL_{cavity} is measured by a **strainmeter**
- **cavity length fluctuation** ΔL_{cavity} is calculated from the **feedback signal**

Earth tides

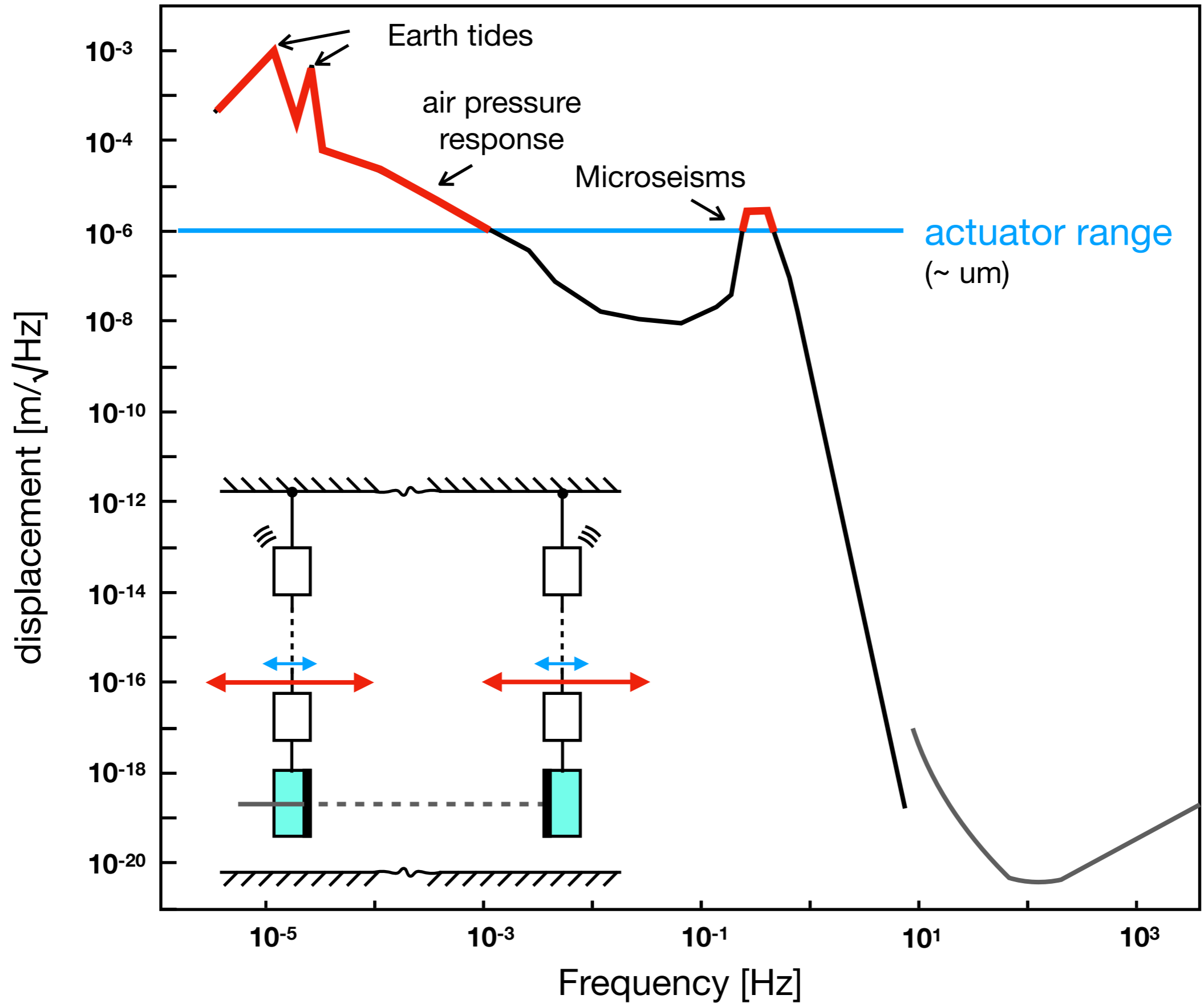

Results

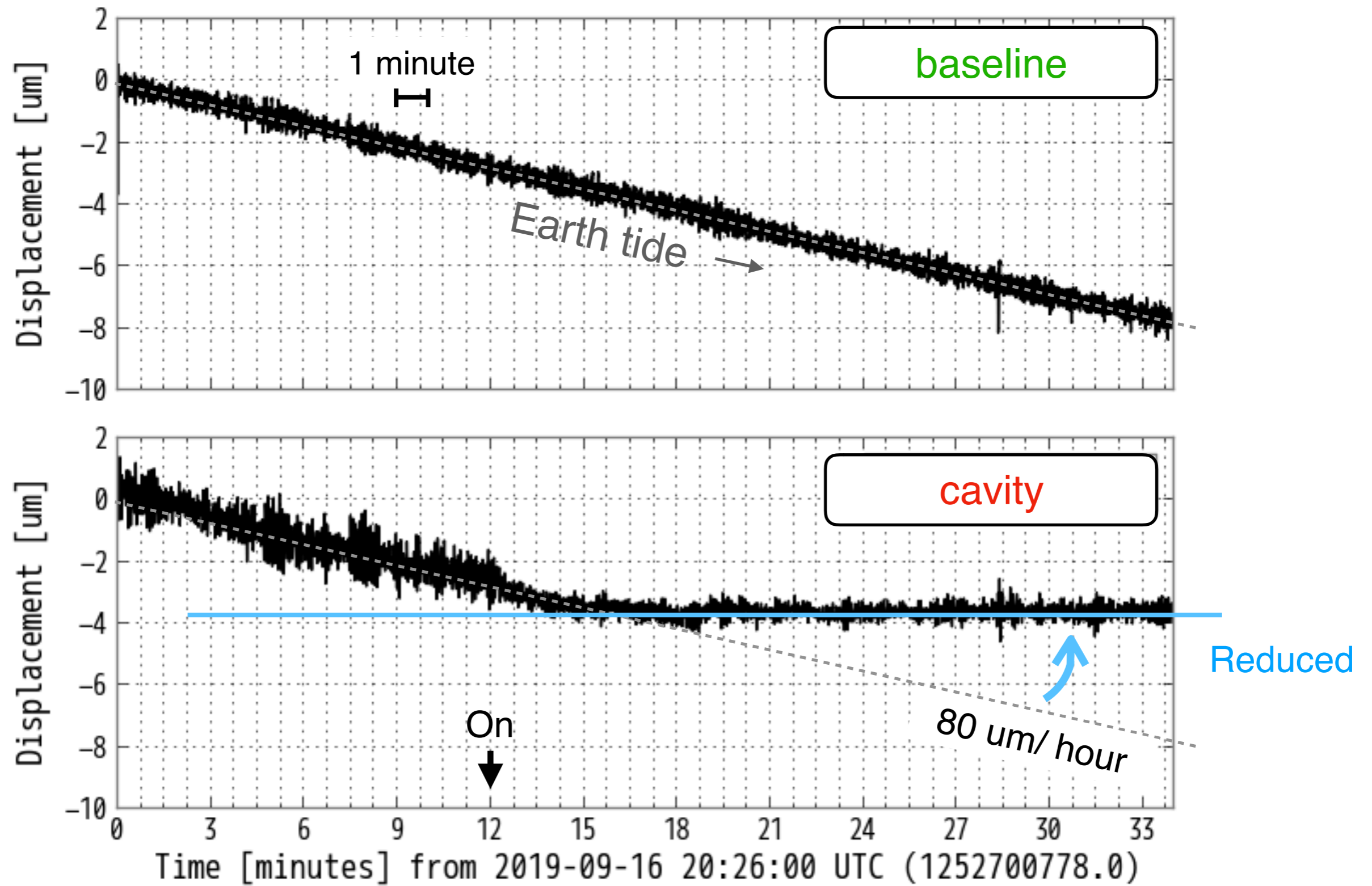

Microseismics

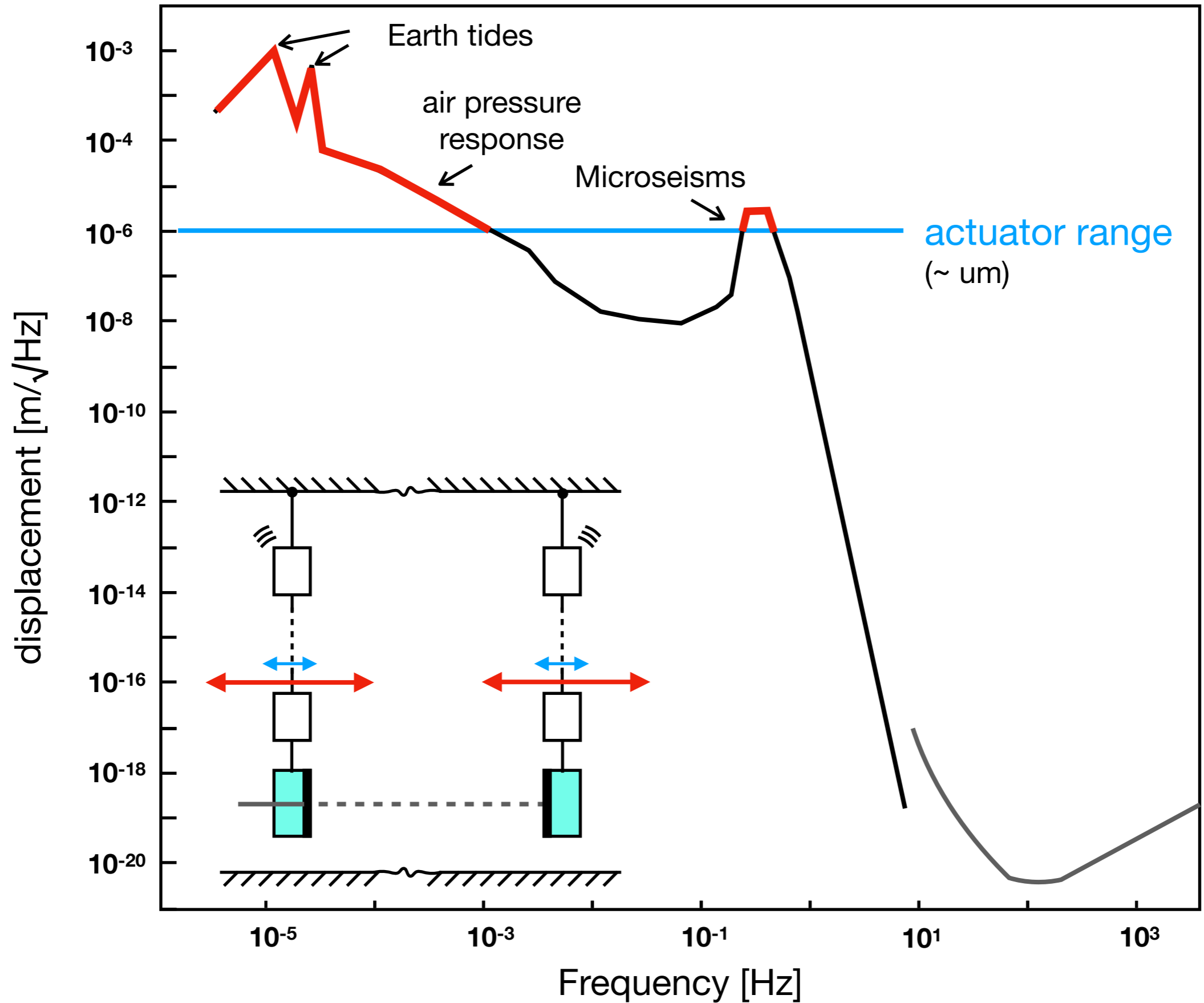

Results

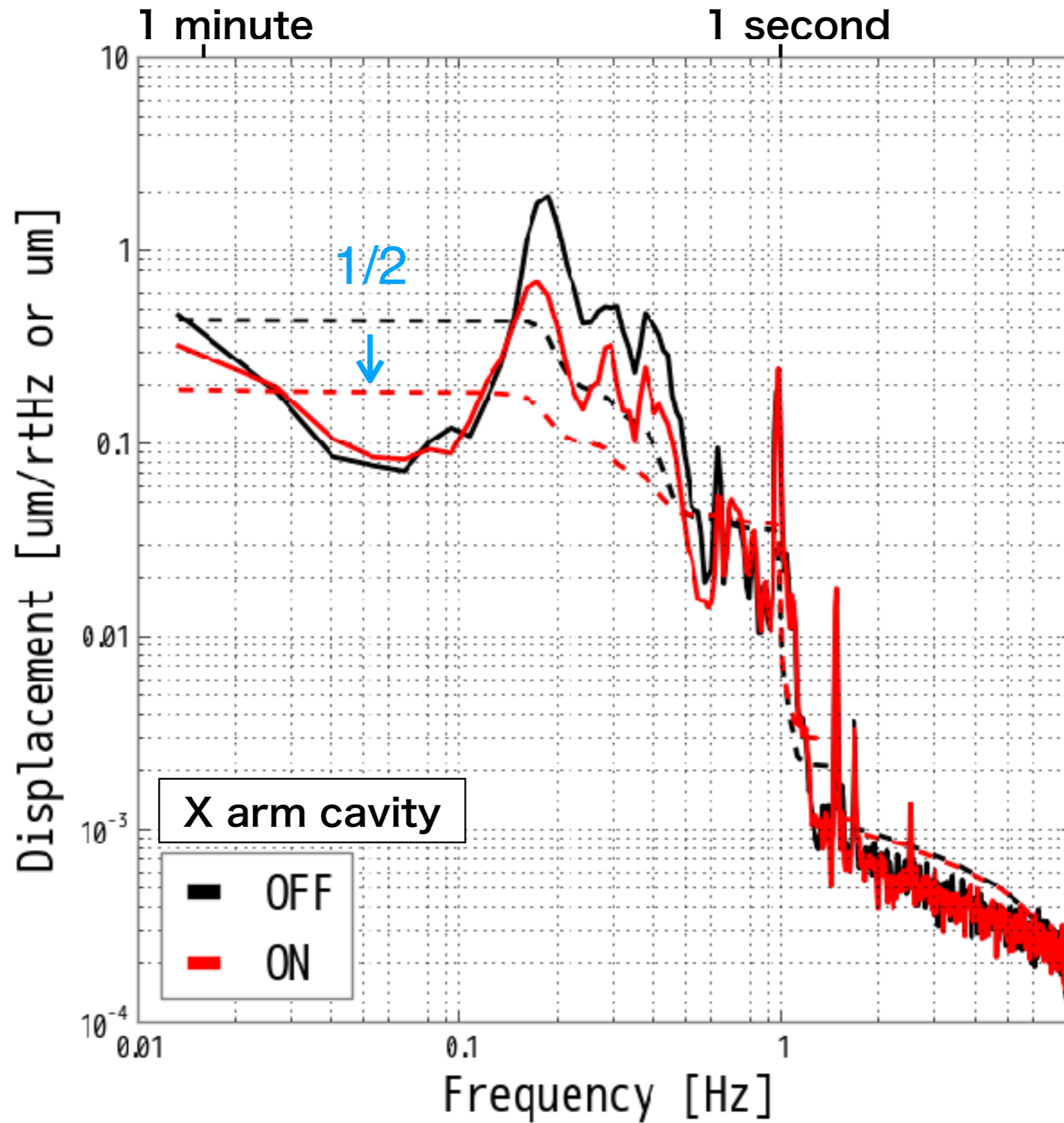

Contents

1. Motivation

- Duty cycle of the GW detectors
- Problems of seismic motion in large-scale GW detectors

2. Review of the previous seismic isolation system

- Seismic isolation for stable operation
- Limit of the current system

3. Baseline Compensation System

- Overview
- Comparison between our system and previous system

4. Demonstration and its results

- Setup for demonstration
- Results

5. Summary

- Conclusion
- Future prospects

Conclusion

- In order to improve the **duty cycle**, which is limited by **seismic motions** on the arm cavity in the **low-frequency** band, we need to reduce these disturbances.
- We designed the **baseline compensation system** and demonstrated its performance by using the X-arm cavity of KAGRA.
- As a result, this new system had **compensated the fluctuation** of the arm cavity.
- This is the first demonstration of the baseline compensation on the km-scale GW detector in the world.

Future prospects

- To eliminate the internal coupling from other degrees of freedoms, we will evaluate the performance of the compensation system in the case that local feedback loops are not engaged. (KAGRA is now under the commissioning of that)
- Install a strainmeter at the Y-arm and compensate the both arm cavities.

Backup

要点

- 本研究の目的は、重力波検出器の観測可能期間 (duty cycle) を向上させることである。個々の検出器の duty cycle の向上は、複数台同時観測が必須である重力波観測にとって、重要な課題である。
- Duty cycle は、主に 1 Hz 以下の低周波地面振動によって制限されている。なぜならば現在の防振システムは、制御に使用している慣性センサーの感度不足が原因で、これら地面振動に対して十分な防振性能を持っていないためである。
- 本研究では従来方式の問題点を解決するための新しい防振システムを提案し、それによる防振を実証した。これにより地面振動で制限されている duty cycle を直接向上させることが期待される。

Duty cycle of GW detectors

e.g. LIGO detectors during the first observation (O1)

- O1 : 12 Sep. 2015 - 19 Jan. 2016 (49 days)

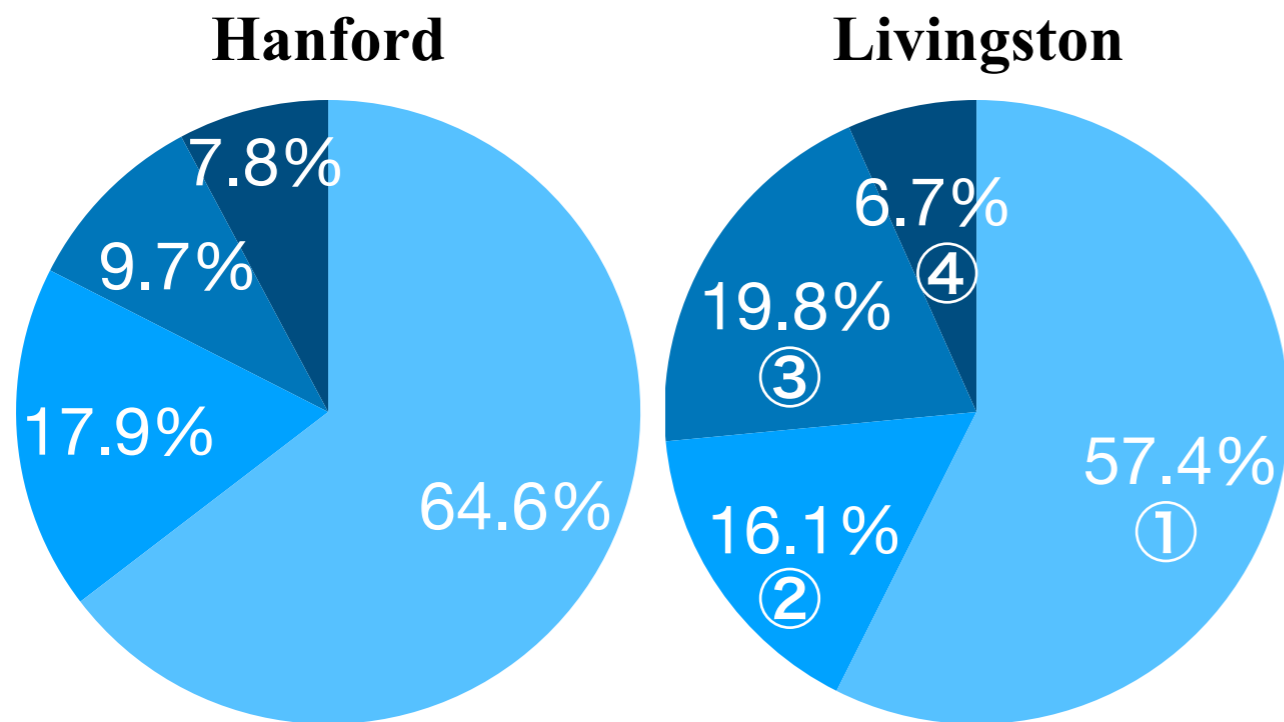

Abbott, B. P., et al. *Living Reviews in Relativity* **21** (2018) 3.

1. **“Observing”**
 - Observation status. (= duty cycle)
2. **“Locking”**
 - Just locking the interferometer but noisy. Can not observe.
3. **“Environmental”**
 - Can not even lock due to environmental disturbances
4. **“Others”**
 - Maintenance and commissioning

- line

Duty cycle of GW detectors

arXiv:1304.0670v9

	Status	O1		O2		Virgo
		Hanford	Livingston	Hanford	Livingston	
Operating mode %	Observing	64.6	57.4	65.3	61.8	85.1
	Locking	17.9	16.1	8.0	11.7	3.1
	Environmental	9.7	19.8	5.8	10.1	5.6
	Maintenance	4.4	4.9	5.4	6.0	3.1
	Commissioning	2.9	1.6	3.4	4.7	1.1
	Planned engineering	0.1	0.0	11.9	5.5	—
	Other	0.4	0.2	0.2	0.2	2.0

- **“Observing”**
 - Observation status
- **“Locking”**
 - Not observation but just locking the interferometer
- **“Environmental”**
 - Not even locking due to environmental disturbances
- **O1** (49 days)
 - 12 Sep. 2015 - 19 Jan. 2016
 - “Environmental” ratio raised in winter season.
- **O2** (117 days)
 - 30 Nov. 2016 - 25 Aug. 2017
 - AdV join on 1 Aug. 2017
 - Avoided winter season

Fabry–Pérot optical resonance cavity

- Resonance condition

- Resonance condition

- The cavity can resonate within the linewidth which is given by

$$L_{\text{FWHM}} = \frac{\lambda}{2\mathcal{F}} \quad \left(\mathcal{F} = \frac{\pi\sqrt{r_1 r_2}}{1 - r_1 r_2} \right)$$

- Arm cavity has the most small linewidth (a few nm)
 - **Arm cavity is a most fragile cavity against the displacement noise ΔL .**

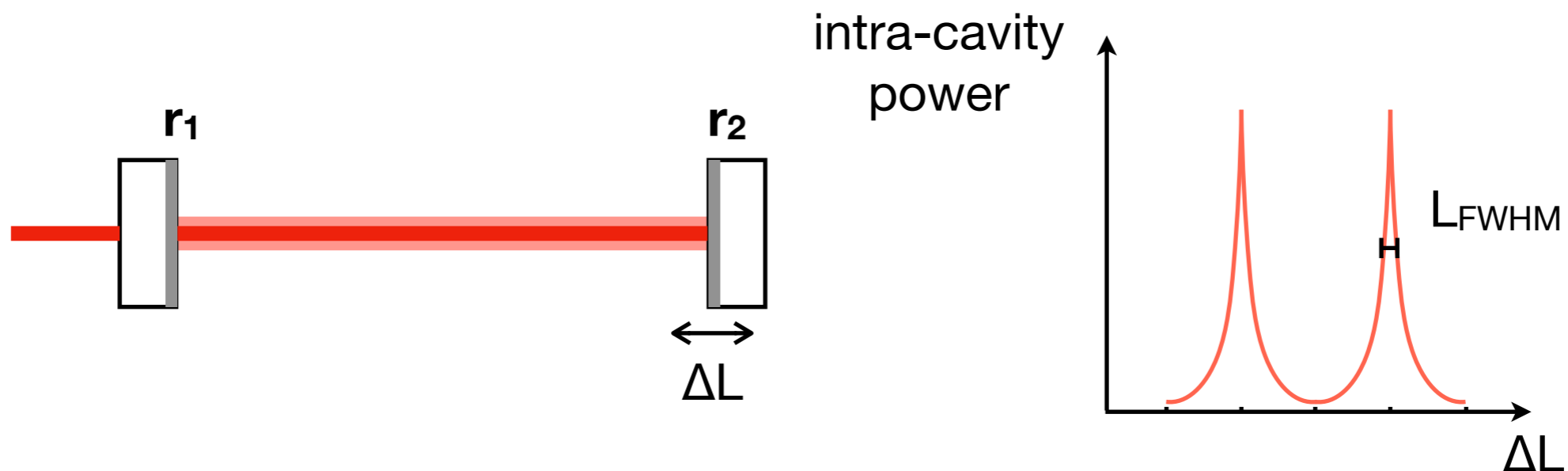

Gravitational-wave (GW)

flat space-time

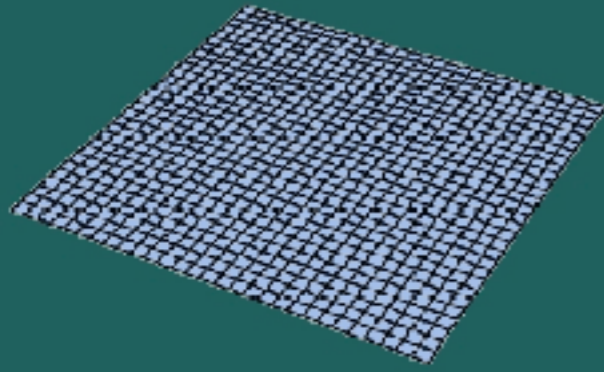

curved space-time

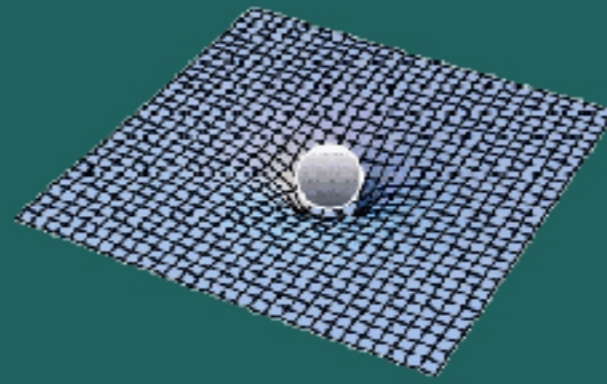

GW emission
(e.g. neutron star binary)

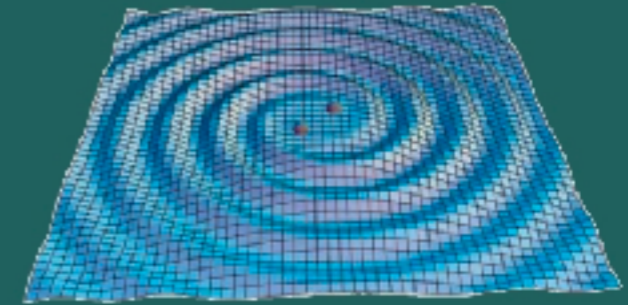

<https://gwcenter.icrr.u-tokyo.ac.jp/plan/aboutu-gw>

連星合体

supernovae explosion



https://www.nasa.gov/multimedia/imagegallery/image_feature_1604.html

パルサー

GW detector

- 重力波が到来すると、空間は潮汐変形する

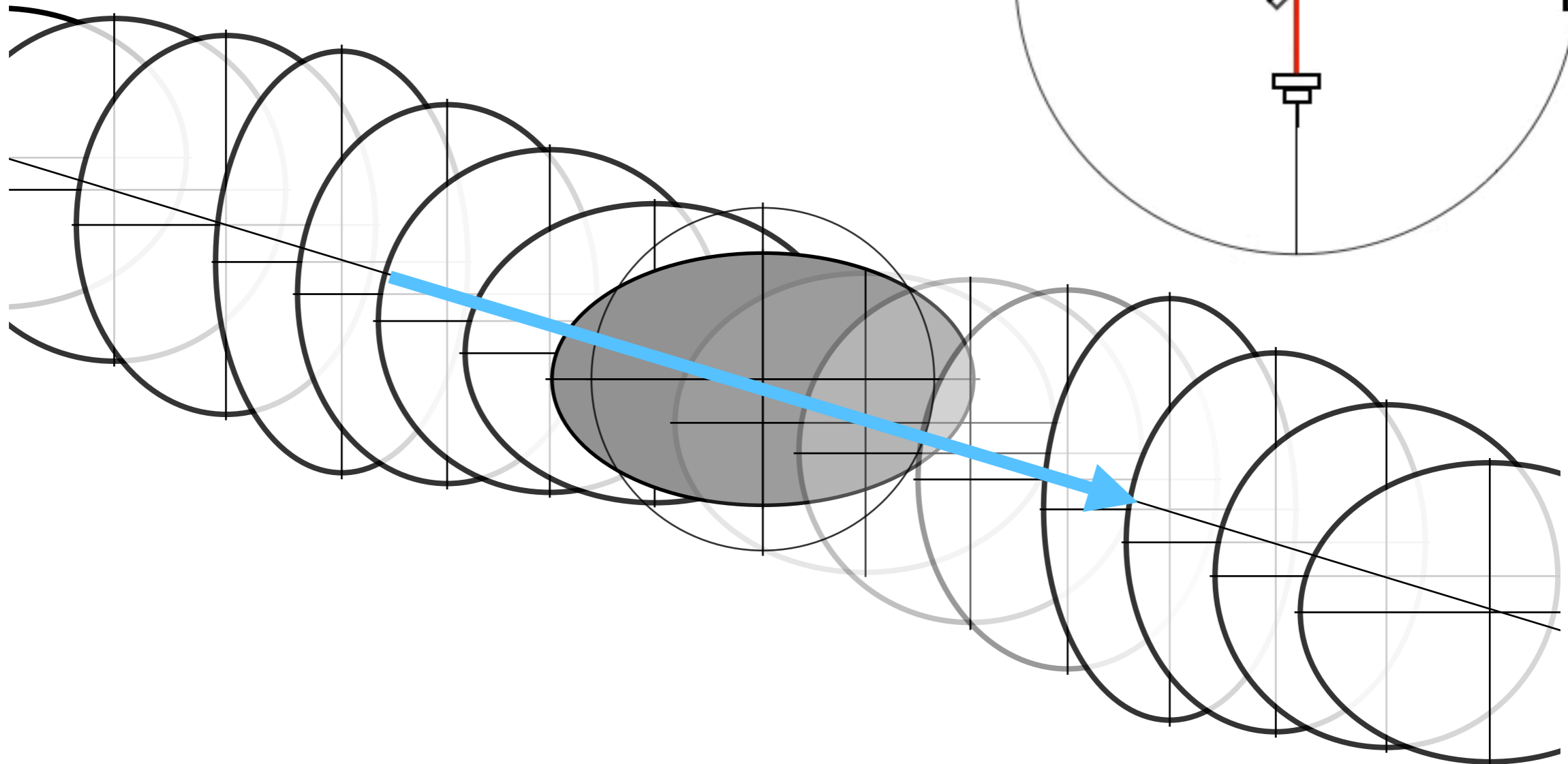

GW detectors network

LIGO Hanford



Virgo



LIGO Hanford

LIGO Livingston

Virgo

KAGRA

LIGO India

LIGO Livingston



Operational
Under Construction
Planned

<https://www.ligo.caltech.edu/image/ligo20160211c>

KAGRA



GW150914: binary black hole merger

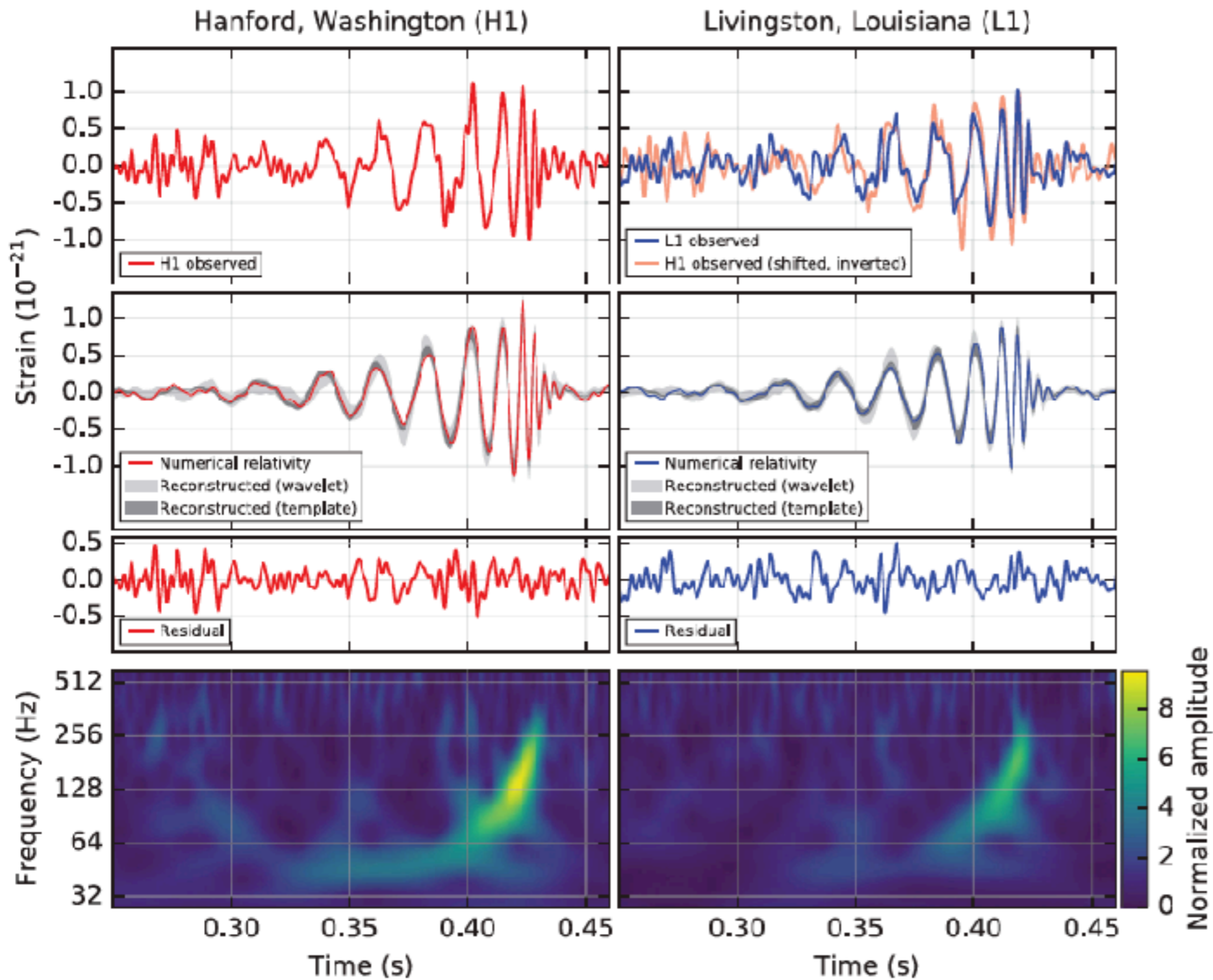

- Detected by 2 LIGO detectors

Abbott, B. P., et al. *Phys. Rev. Lett.* **116**, (2016), 061102.

GW170817: binary neutron star inspiral

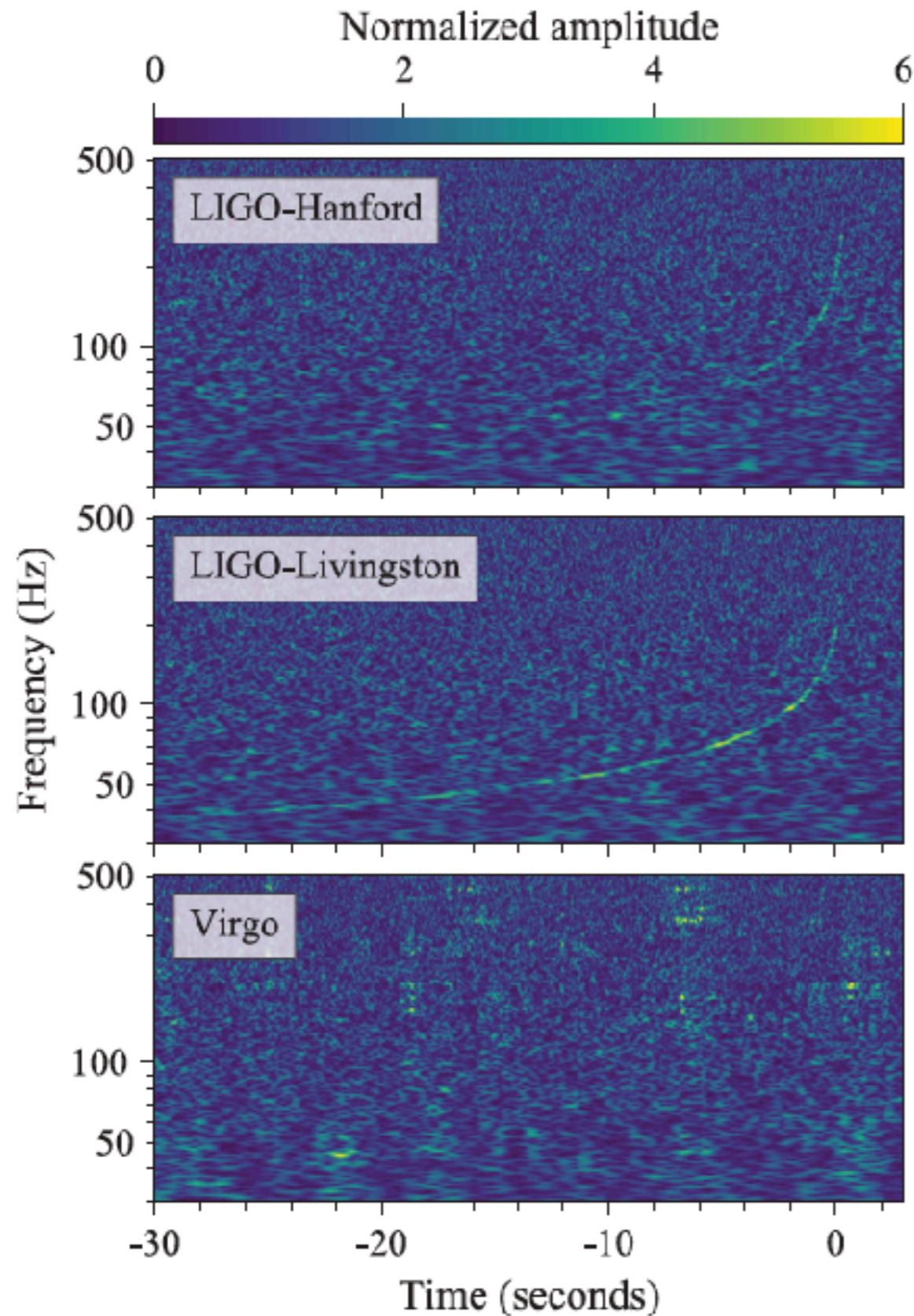

- Detected by 3 detectors
- LIGOの2台は明瞭にチャープ波形をうけてVirgoは死角にいた。
- しかし3台目のおかげで到来方向を決定する助けになった。

Sky localization of GW170817

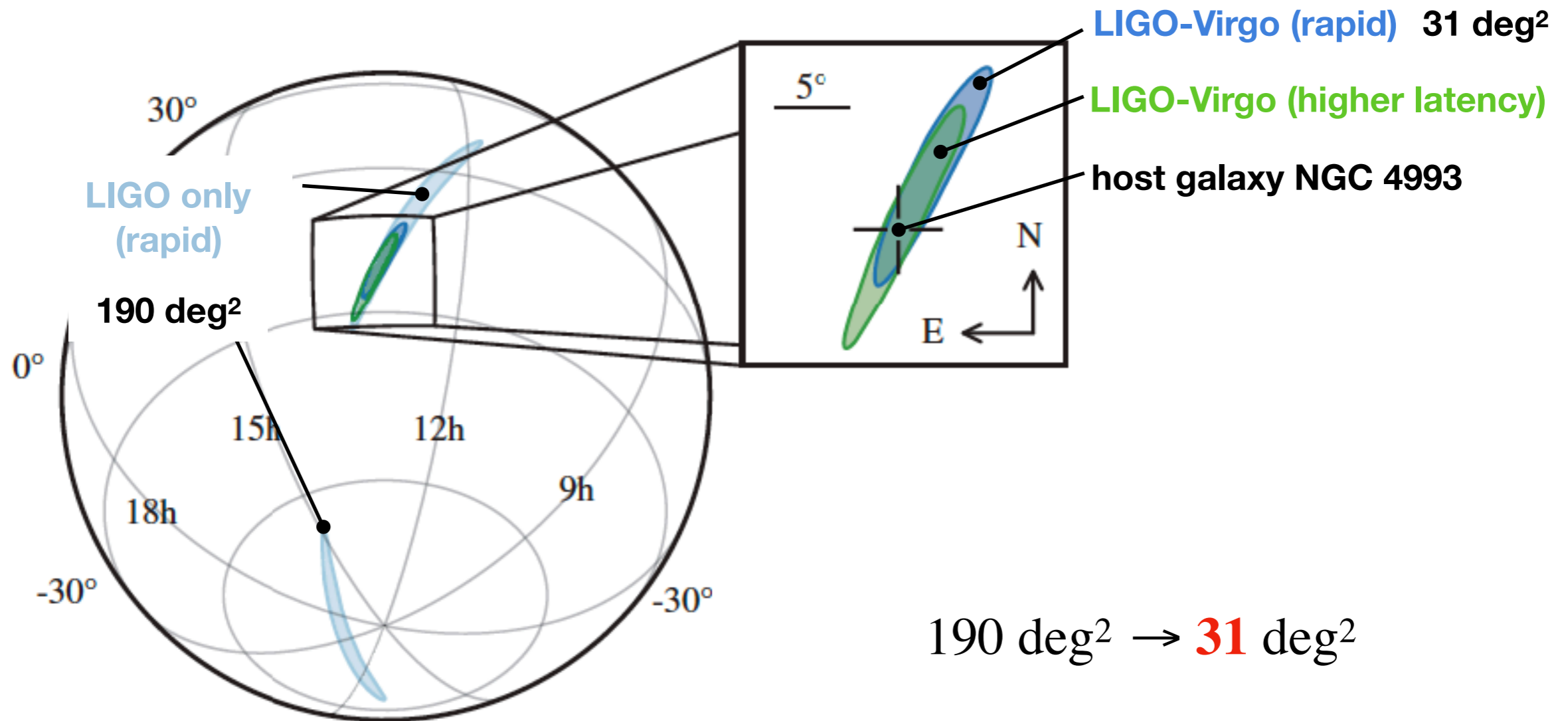

Abbott, B. P., et al. *Phys. Rev. Lett.* **119**, (2017), 161101.

Multi-messenger observation

LIGO
190 deg² → **31** deg²

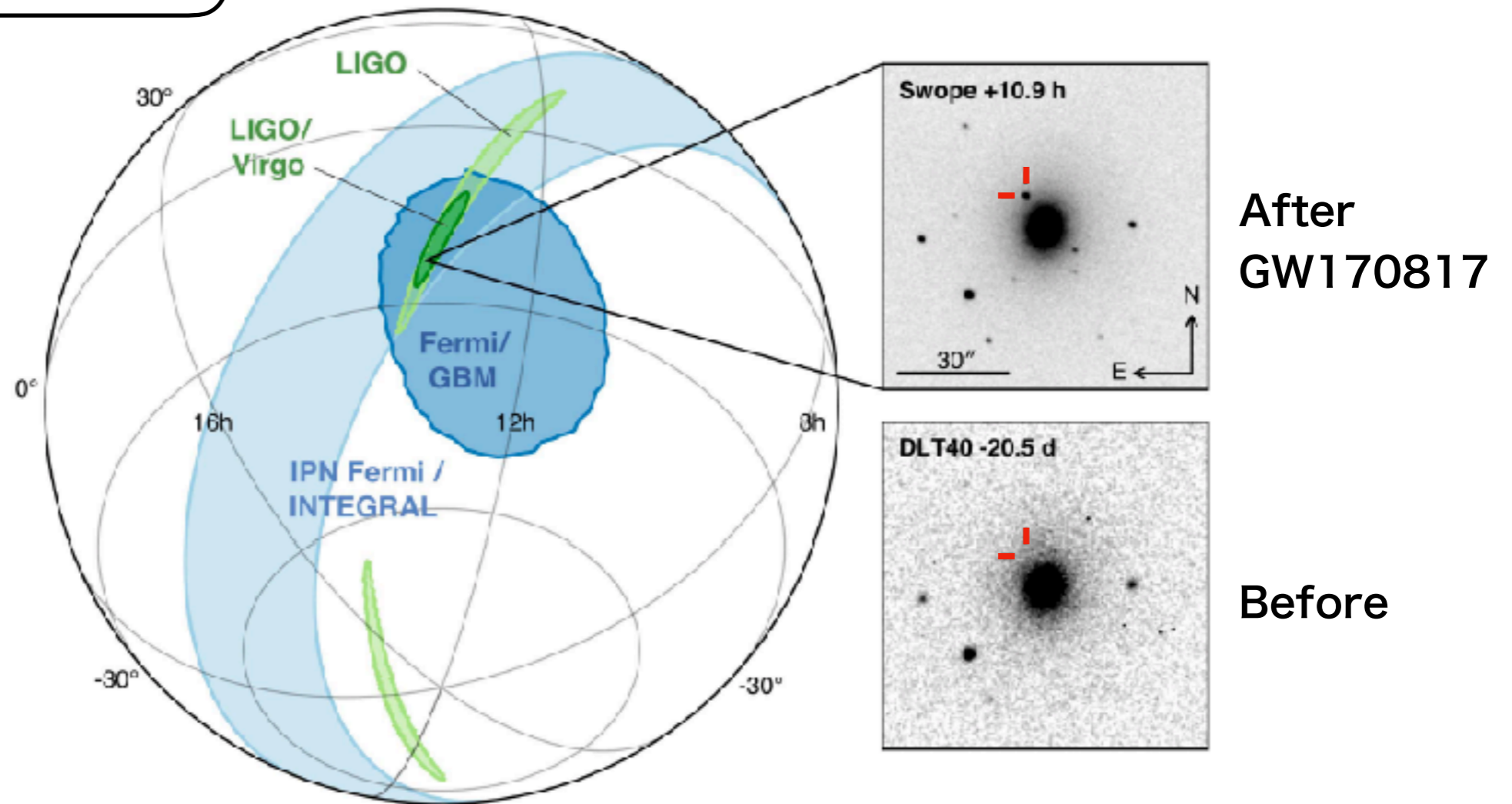

Abbott, B. P., et al. *Astrophys. J. Lett.* **848**, (2017), L12.

- Many **electromagnetic counterparts discovered** in Ultraviolet, optical, infrared, Gamma-rays, X-rays, and radio.
- To localize the GW sources, we must **operate 3 detectors** simultaneously.

Detection principle of GW

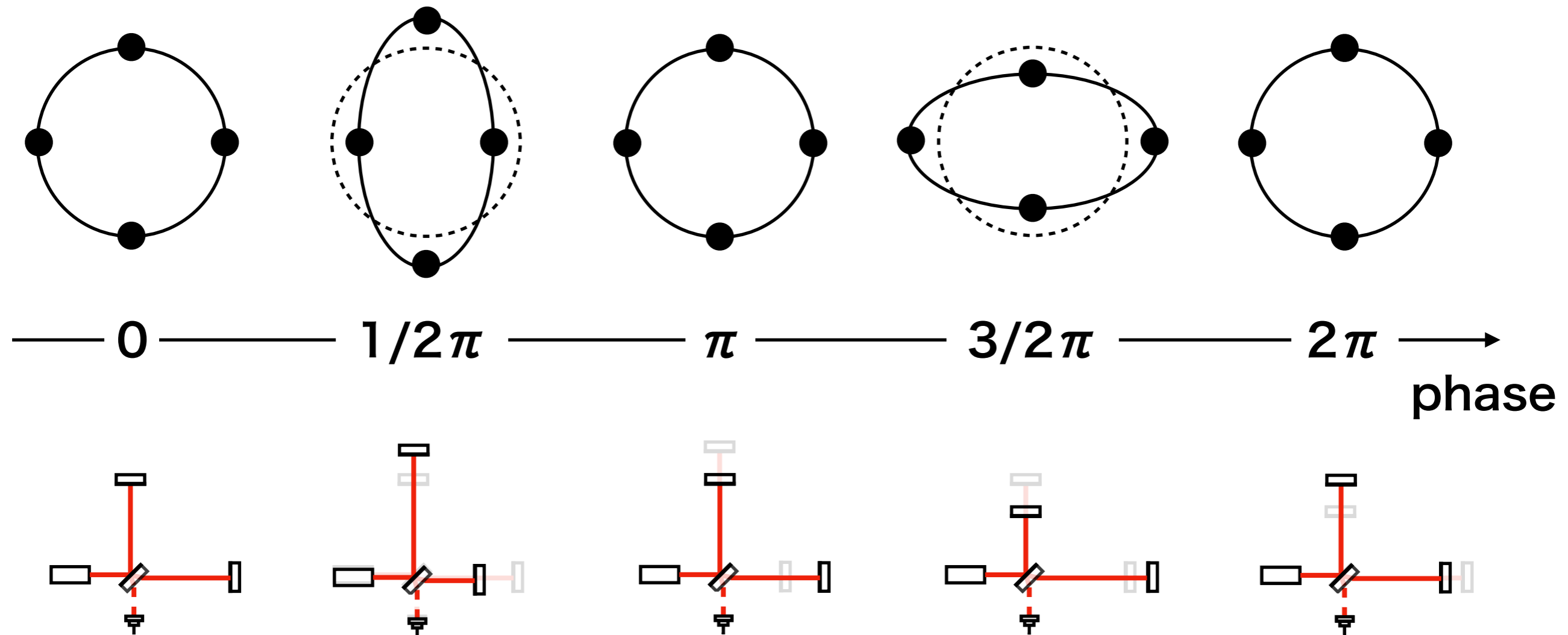

- GW
- Michelson interferometer sensitive to the differential arm motion.

DC制御でよくないか？

- 基本的にはそれでいい。LIGOやVirgoはそうしている。
- しかし地震のような大きな外乱で干渉計はロックロスしてしまっている。（技術的なことをいえば、DC制御のための積分器とダンピングのための微分器が交差する周波数帯域ではFBゲインがもっとも小さく、防振が十分ではない。つまりそこを揺らす地震に弱いことを意味する。この交差周波数はおよそ 0.1 Hz 程度。）
- できるだけ上の段で粗調し、下の段のFB制御の負担をへらすことが大事。

ALS との比較

- Arm Length Stabilization
 - for lock acquisition
 - cannot use in observation state due to high noise
 - improve “locking” down-time
- Baseline Compensation
 - for vibration isolation
 - can use any state
 - improve “environmental” down-time

Comparison with the simulation

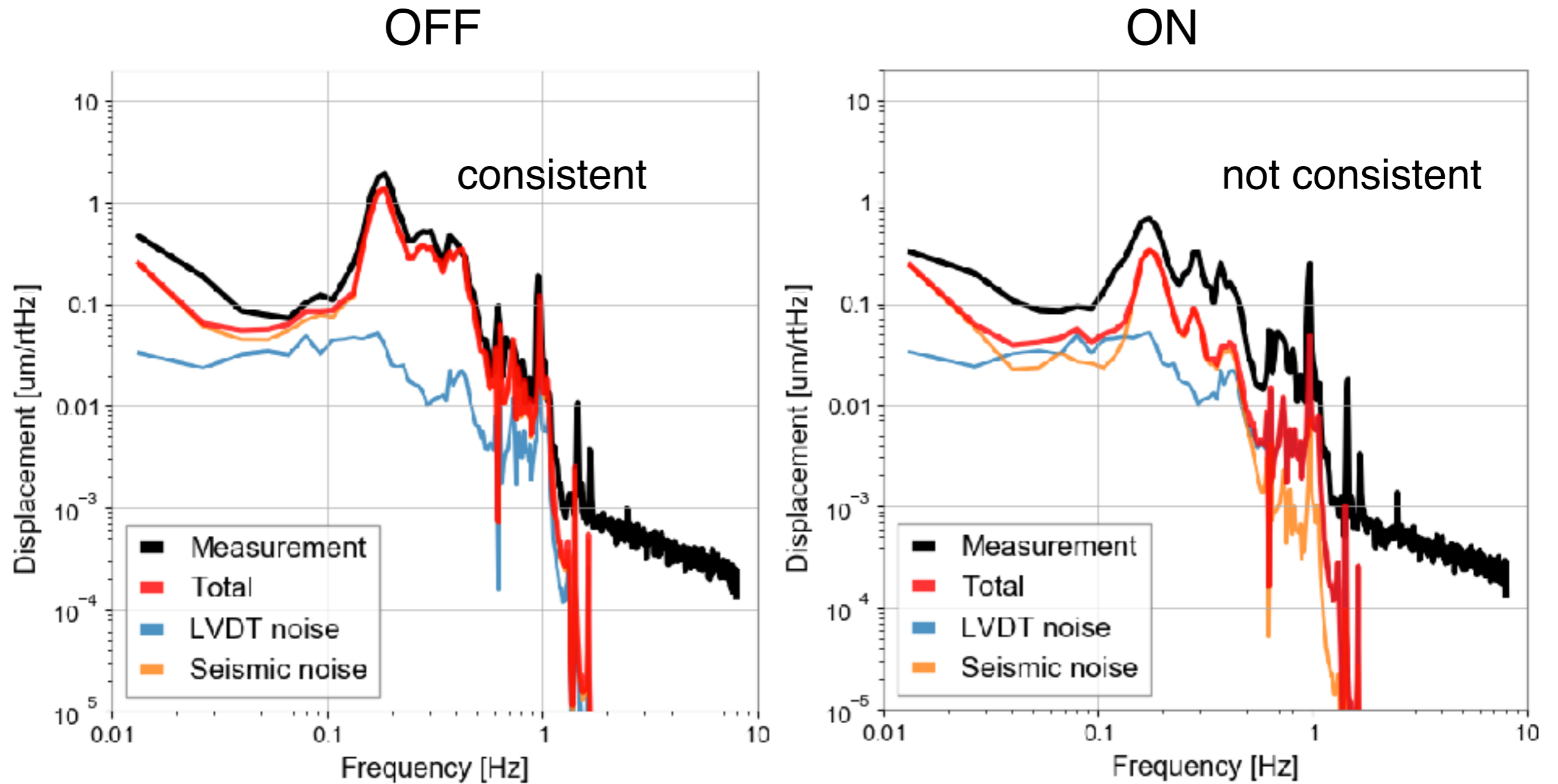

- OFF : Measurement was consistent with the model simulation
- ON : Measurement was not

Discussion

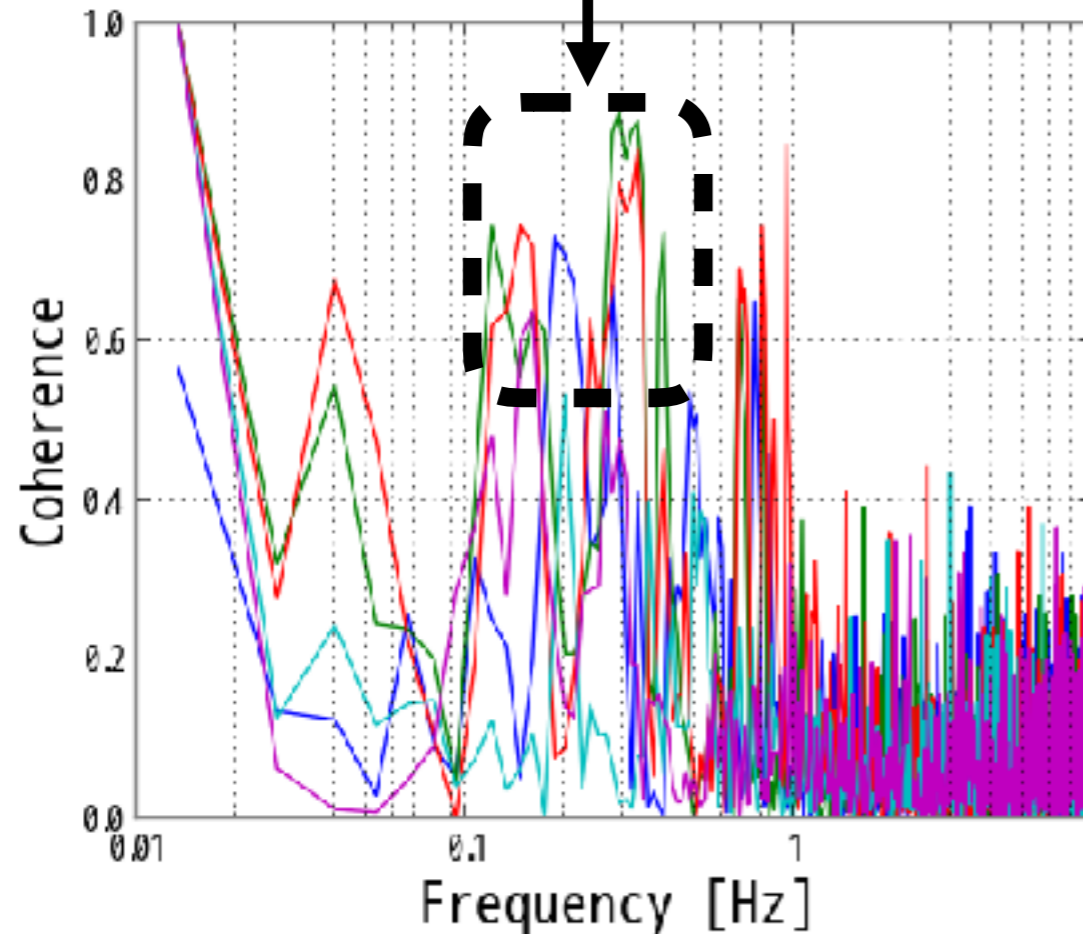
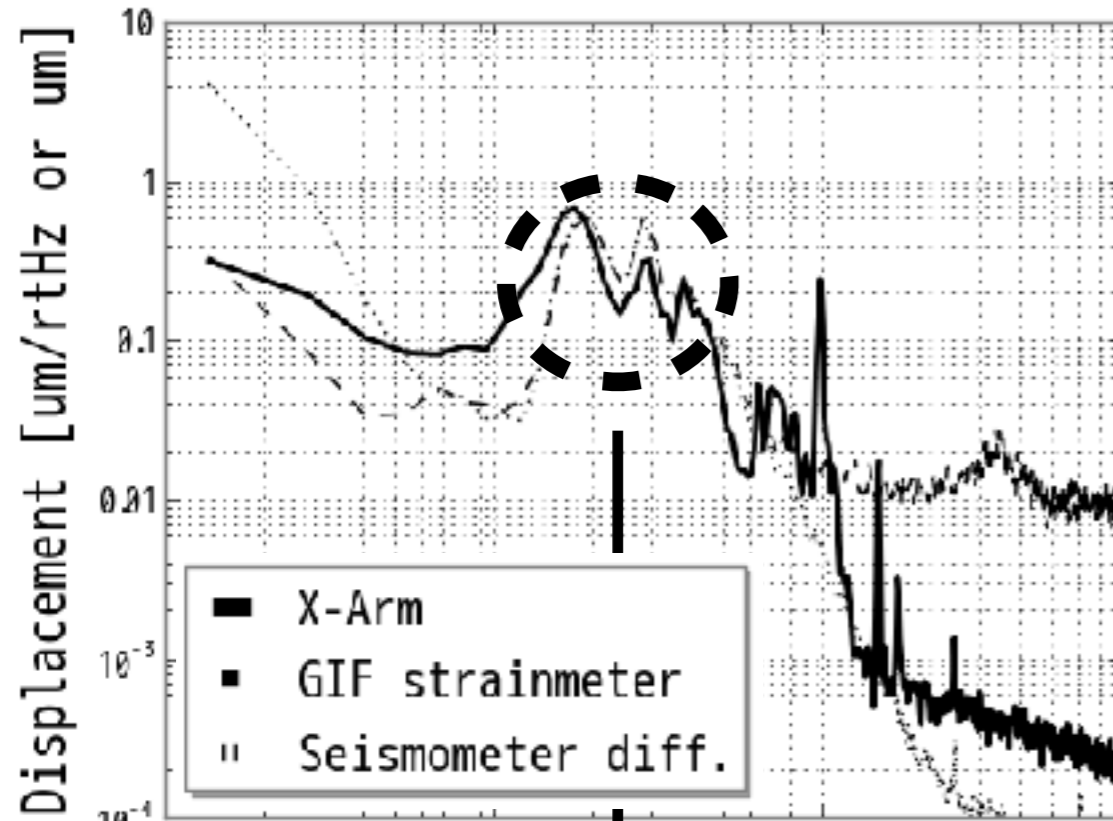

- X-arm vs. GIF
- X-arm vs. ITMX_IP_Y_DAMP
- X-arm vs. ITMX_IP_T_DAMP
- X-arm vs. ETMX_IP_Y_DAMP
- X-arm vs. ETMX_IP_T_DAMP

