

# Sensitivity Optimization of **Cryogenic** Gravitational Wave Detectors

Yuta Michimura

Department of Physics, University of Tokyo

Kentaro Komori, Atsushi Nishizawa, Hiroki Takeda,  
Koji Nagano, Yutaro Enomoto, Kazuhiro Hayama,  
Kentaro Somiya, Masaki Ando

# Overview

- **Cryogenic** GW detectors require careful design
  - tradeoff between laser power and temperature
  - simultaneous tuning of multiple parameters
- **Particle swarm optimization**
  - **simple** algorithm, few design variables
  - **fast** even with many parameters
- Applied for **KAGRA** sensitivity design
  - re-tuned 7 parameters
  - **inspiral range** optimization
  - **sky localization** optimization
- YM+ [arXiv:1804.09894](https://arxiv.org/abs/1804.09894)

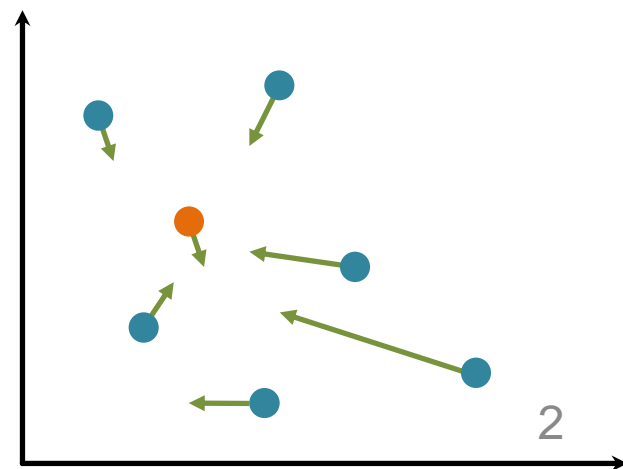

# Room Temperature Design

- **Seismic noise**: reduce as much as possible  
multi-stage suspensions  
underground
- **Thermal noise**: reduce as much as much as possible  
larger mirror  
thinner and longer wires
- **Quantum noise**: optimize the shape  
input laser power  
tune signal recycling parameters

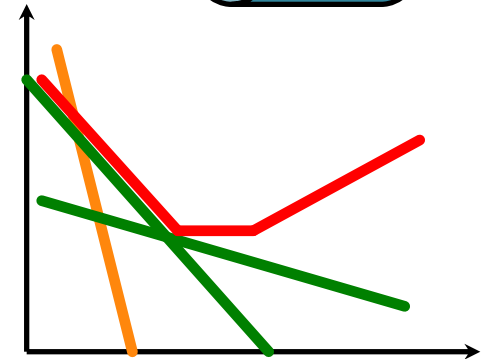
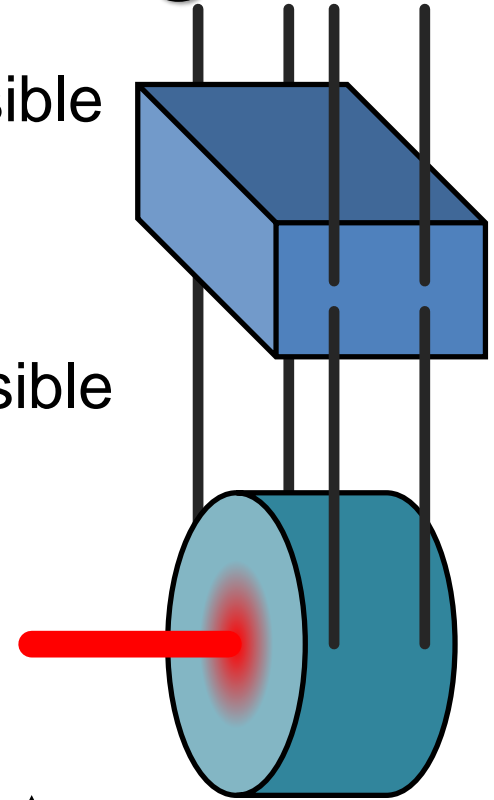

# Cryogenic Design is Complicated

- **Seismic noise**: reduce as much as possible  
multi-stage suspensions  
underground

- **Thermal noise**: reduce as much as possible  
larger mirror  
thinner and longer wires

cryogenic cooling

- **Quantum noise**: optimize the shape  
input laser power  
tune signal recycling parameters

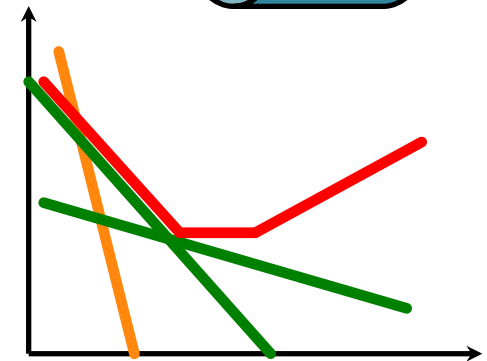
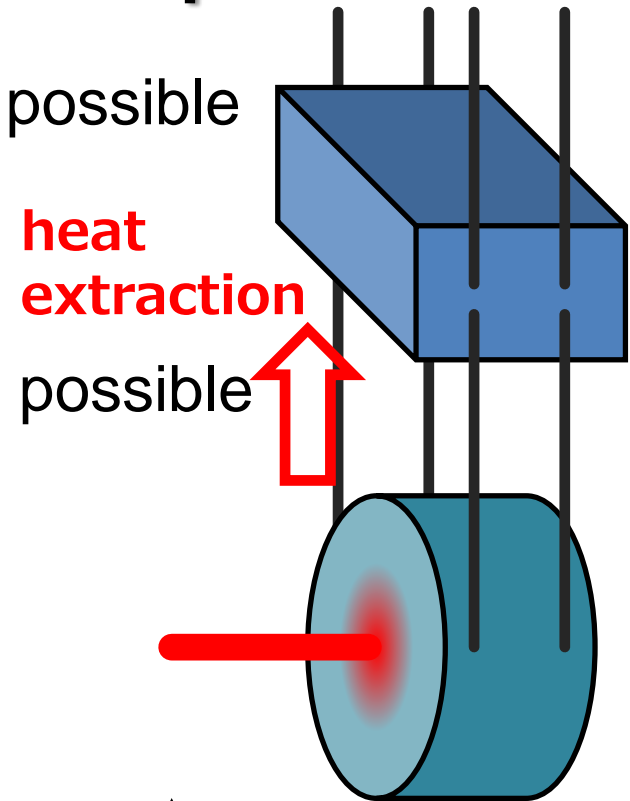

# Cryogenic Design is Complicated

- **Seismic noise**: reduce as much as possible  
multi-stage suspensions  
underground

- **Thermal noise**: reduce as much as possible  
larger mirror  
thinner and longer wires

cryogenic cooling

- **Quantum noise**: optimize the shape  
input laser power  
tune signal recycling parameters

heat  
extraction

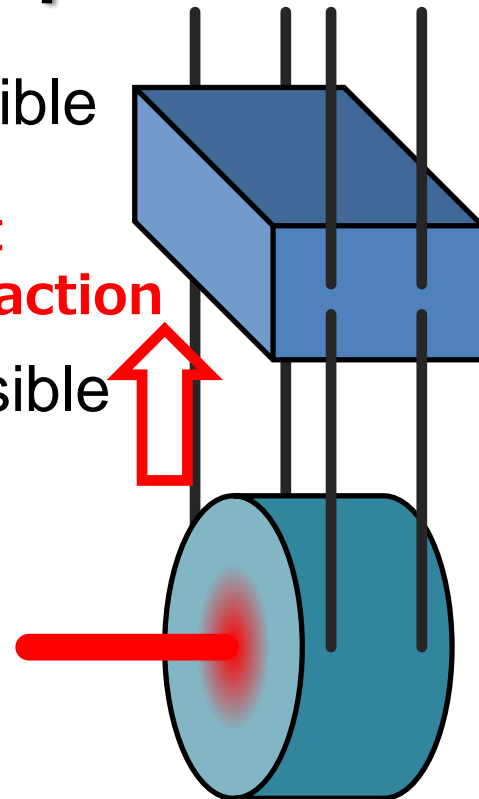

worse cooling power  
mirror heating

# Ancient Method is not Scalable

- Sensitivity design is an optimization problem
- Grid-based parameter search
  - deterministic
  - computational cost grows **exponentially** with number of parameters

- Future GW detectors (with crazy quantum ideas) require more parameters to be optimized
- **Almost impossible** with grid-based approach

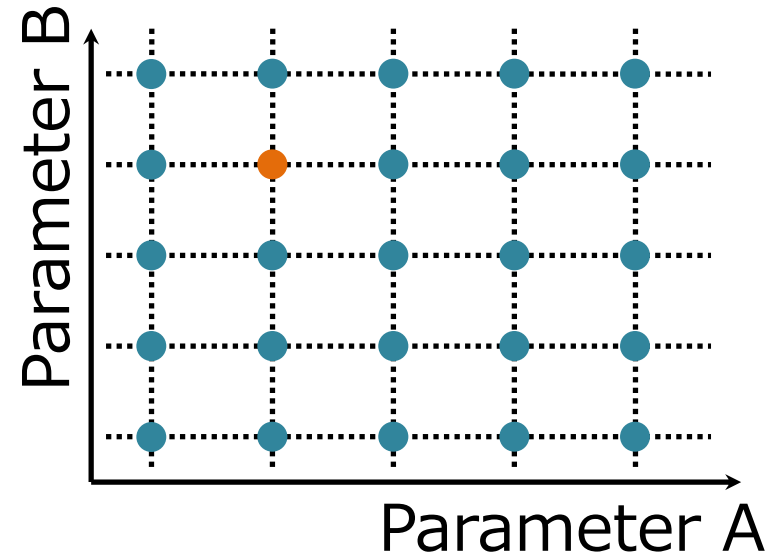

# Particle Swarm Optimization!

- Particles search the parameter space based on **own best** position and **entire swarm's best** known position

$$x_k(t + 1) = x_k(t) + v_k(t)$$

personal best position so far      global best position so far

$$v_k(t + 1) = wv_k(t) + c_1r_1(\hat{x}_k - x_k(t)) + c_2r_2(\hat{x}_g - x_k(t))$$

inertia coefficient  
 $w=0.72$

acceleration coefficient  $c=1.19$   
random number  $r \in [0,1]$

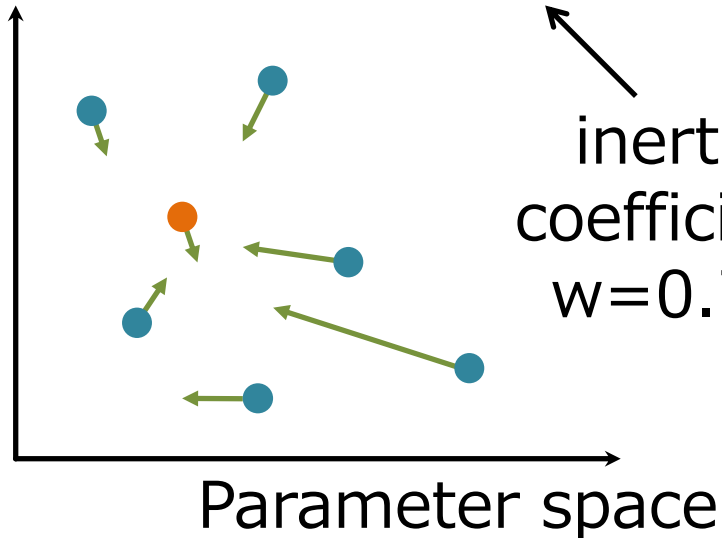

[Kennedy & Eberhart \(1995\)](#)

values for  $w$  and  $c$  are from [Standard PSO 2006](#)





# PSO for GW Related Research

- CBC search
  - Weerathunga & Mohanty, [PRD 95, 124030 \(2017\)](#)
  - Wang & Mohanty, [PRD 81, 063002 \(2010\)](#)
  - Bouffanais & Porter, [PRD 93, 064020 \(2016\)](#)
- Continuous GW search using pulsar timing array
  - Wang, Mohanty & Jenet, [ApJ 795, 96 \(2014\)](#)
- Cosmological parameter estimation using CMB
  - Prasad & Souradeep, [PRD 85, 123008 \(2012\)](#)
- Gravitational lens modeling
  - Rogers & Fiege, [ApJ 727, 80 \(2011\)](#)
- Sensor correction filter design
  - Conor Mow-Lowry, [LIGO-G1700841](#) [LIGO-T1700541](#)
- Voyager quantum noise optimization
  - input power, arm finesse, SRM transmissivity, homodyne, filter cavity





# Pros and Cons of PSO

- **Fast** even for highly **multidimensional** parameter space   
uses entire swarm's information to search
- Requires **small number of design variables** and **little prior information**   
basically only swarm size and termination criterion  
prior information is only search range
- **No guarantee** for convergence to global maximum   
stochastic method
- Do not give **error** of the parameters   
no direct information on stability of the solution

→ Sounds great for detector design

# Apply PSO for KAGRA Design

- RSE interferometer
- Cryogenic sapphire test masses

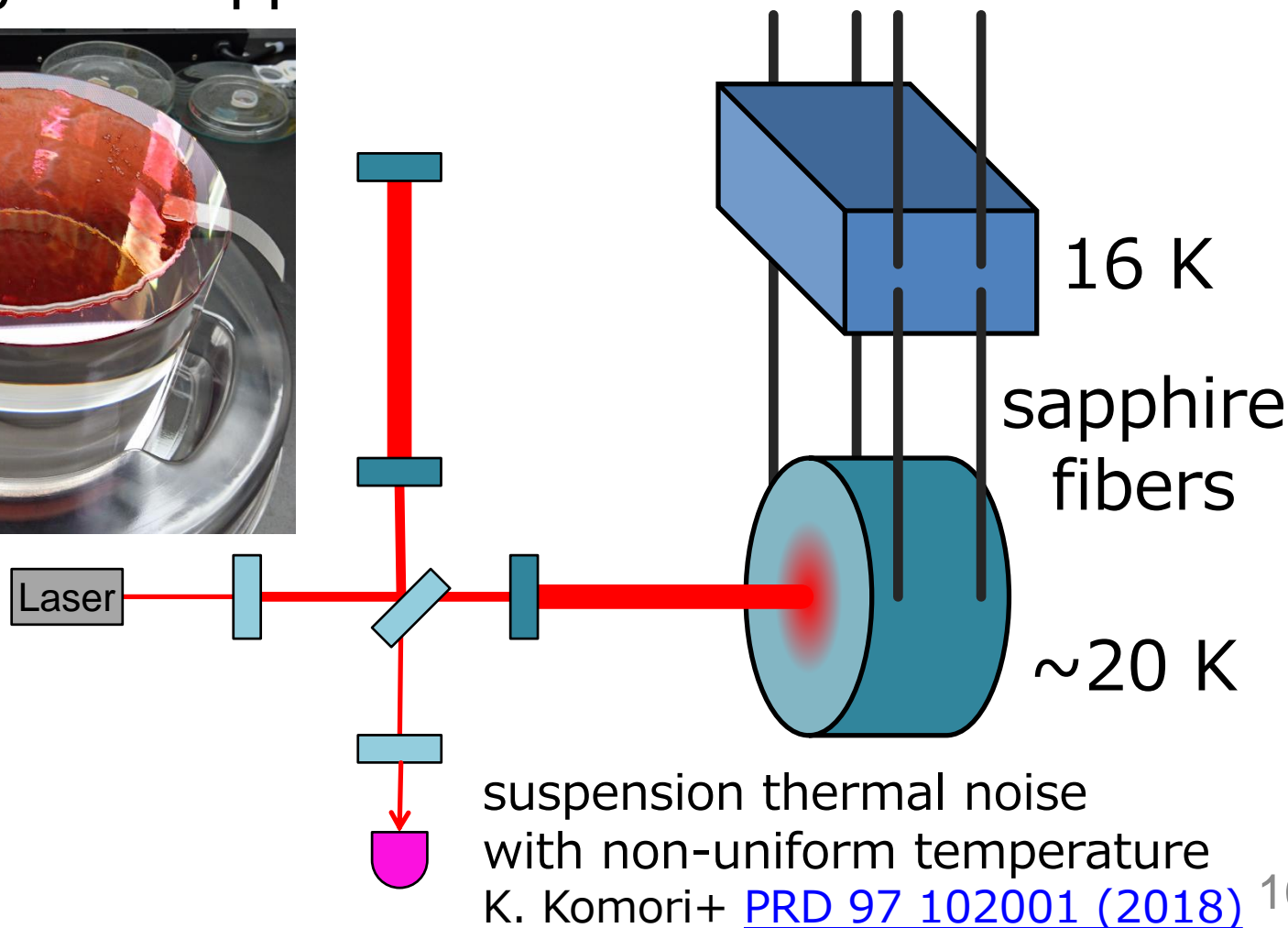
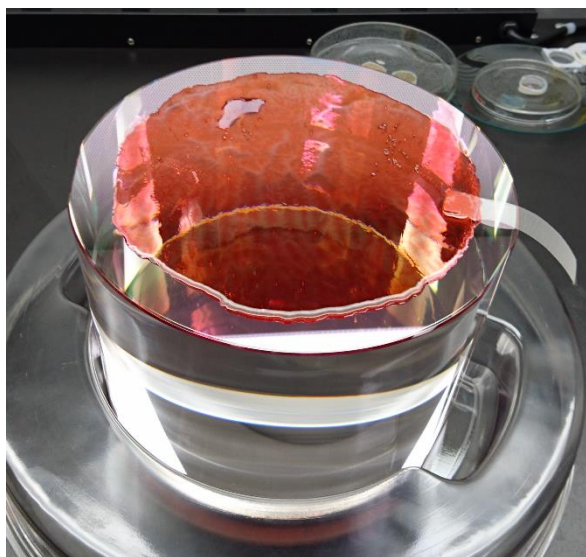

# KAGRA Parameters to Optimize

- 7 parameters relatively easy to be retuned
- Search range based on feasibility

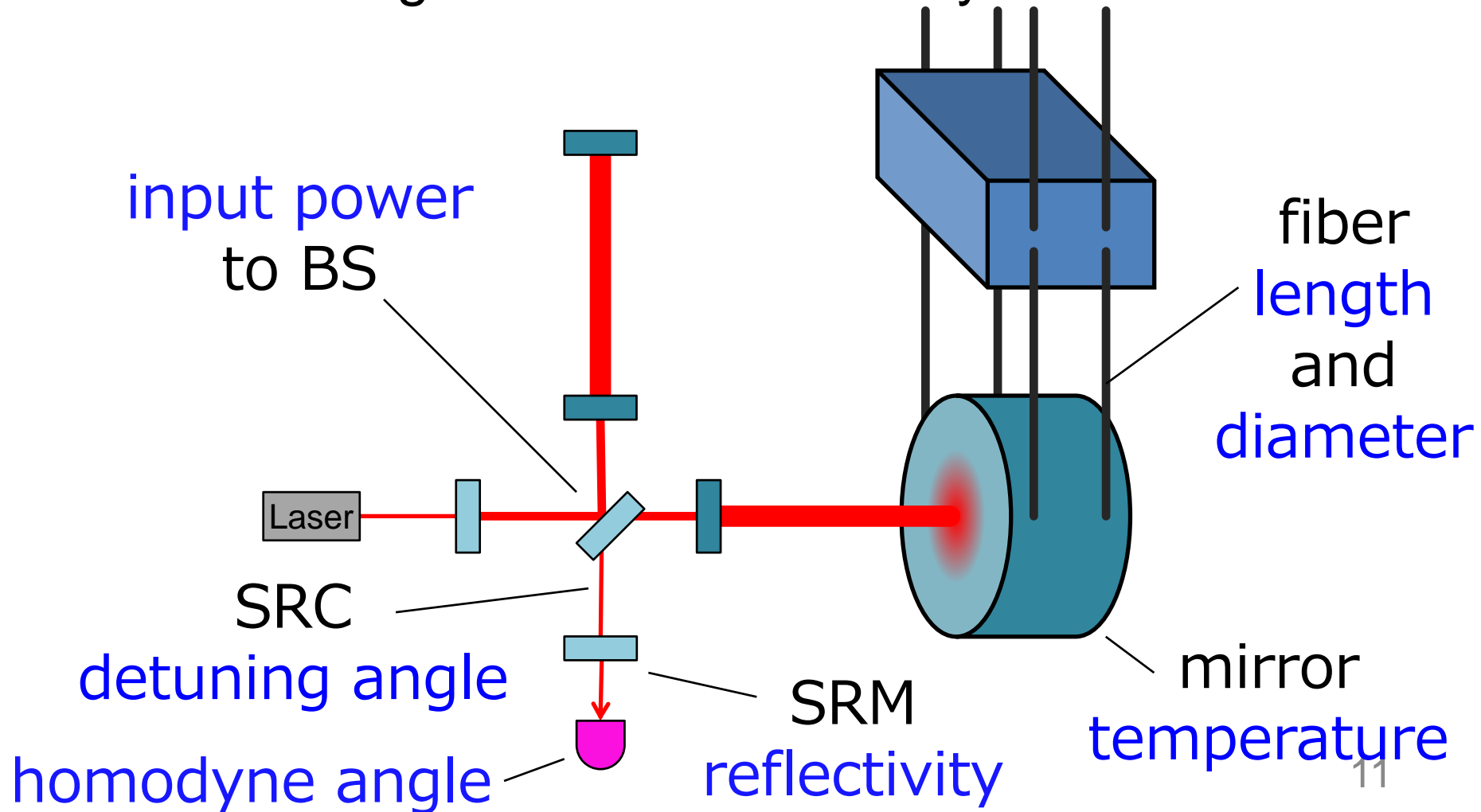

# PSO Algorithm

Swarm size determined by probability of convergence (10~200)

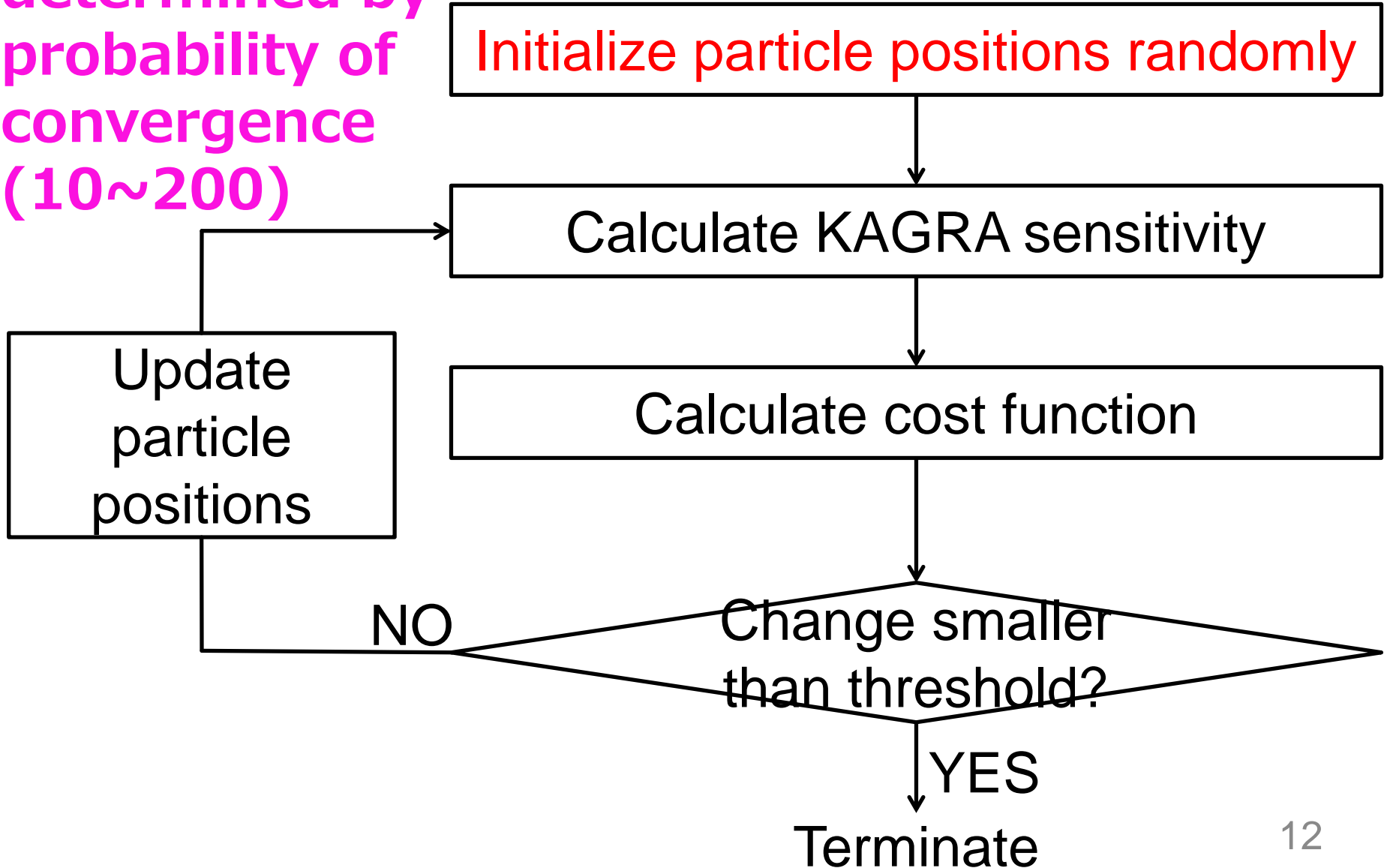

# PSO Algorithm

Initialize particle positions randomly

Calculate KAGRA sensitivity

Calculate cost function

Change smaller than threshold?

YES

Terminate

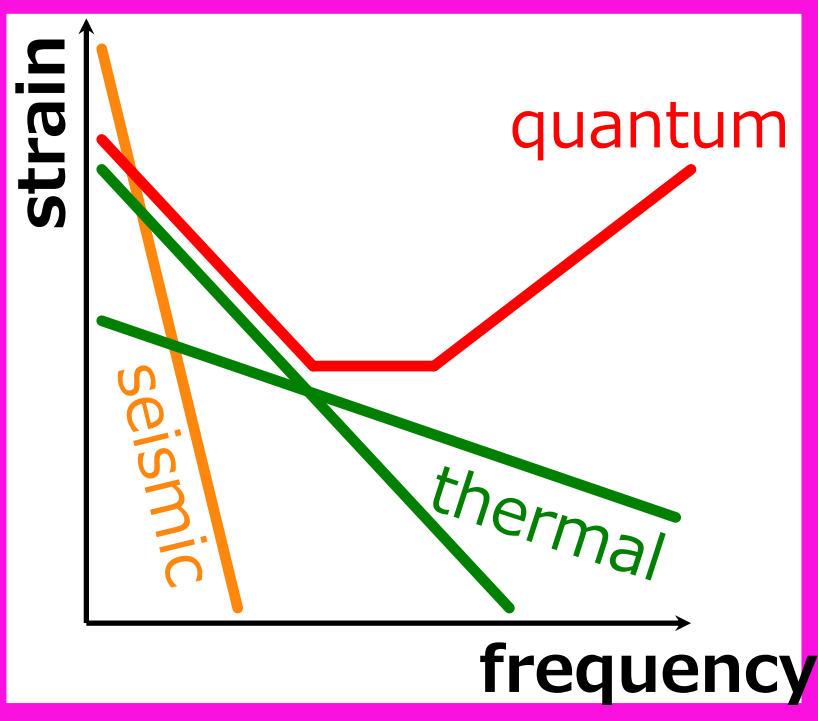

# PSO Algorithm

Initialize particle positions randomly

BNS inspiral range  
as a cost function

Calculate KAGRA sensitivity

Calculate cost function

Change smaller  
than threshold?

YES

Terminate

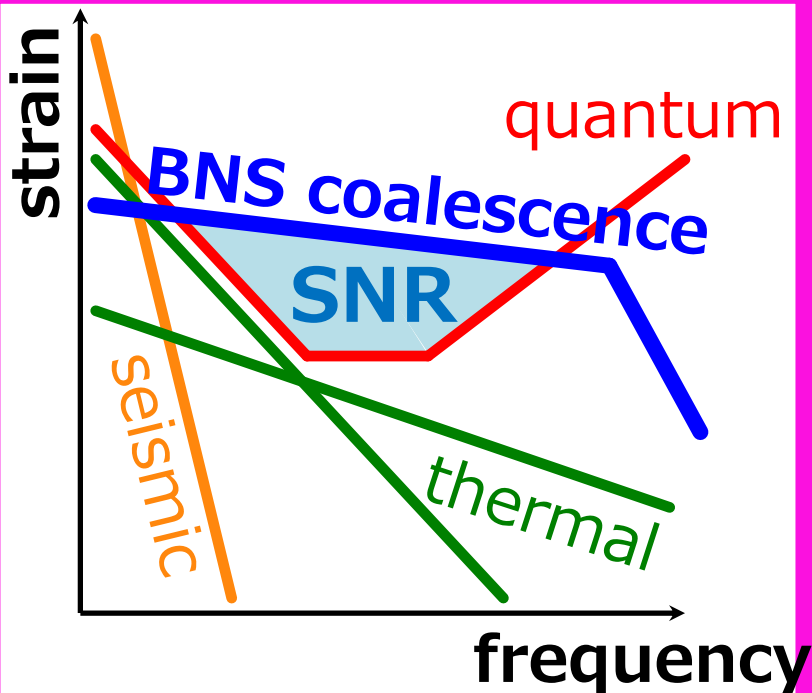

# PSO Algorithm

**BNS inspiral range  
as a cost function**

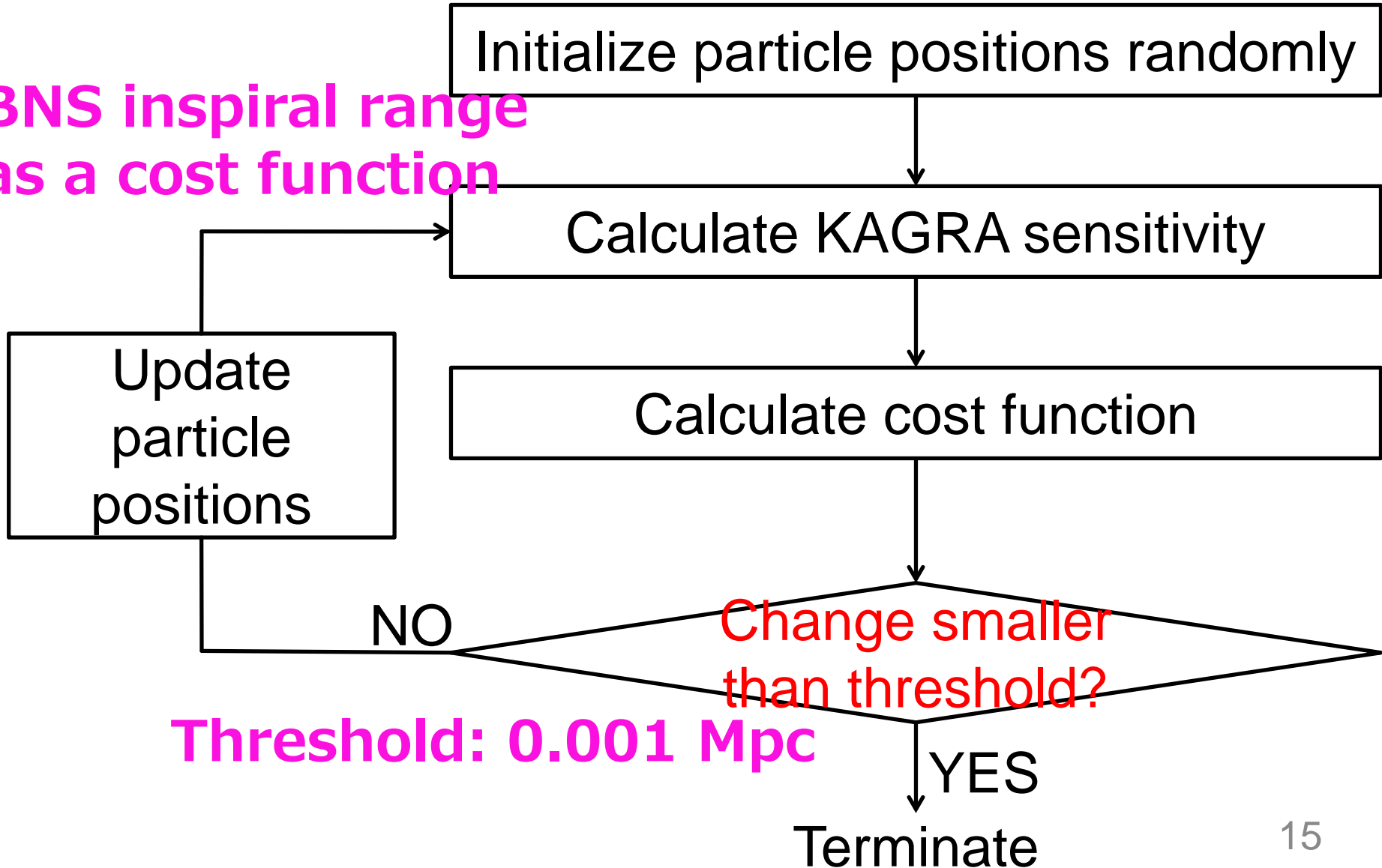

# PSO Algorithm

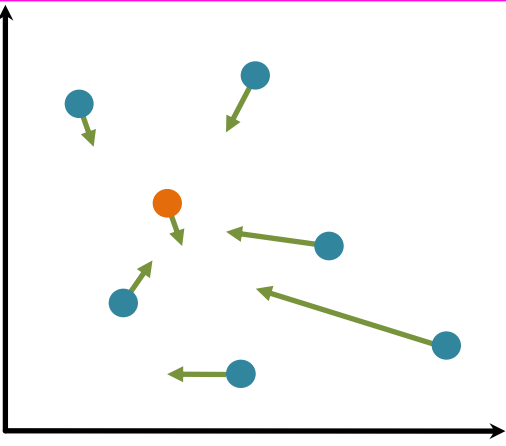

Initialize particle positions randomly

Calculate KAGRA sensitivity

Calculate cost function

Update  
particle  
positions

NO

Change smaller  
than threshold?

YES

Terminate

$$x_k(t+1) = x_k(t) + v_k(t)$$

$$v_k(t+1) = wv_k(t) + c_1r_1(\hat{x}_k - x_k(t)) + c_2r_2(\hat{x}_g - x_k(t))$$



# 3 Parameter Optimization

- **Consistent** with grid-based approach

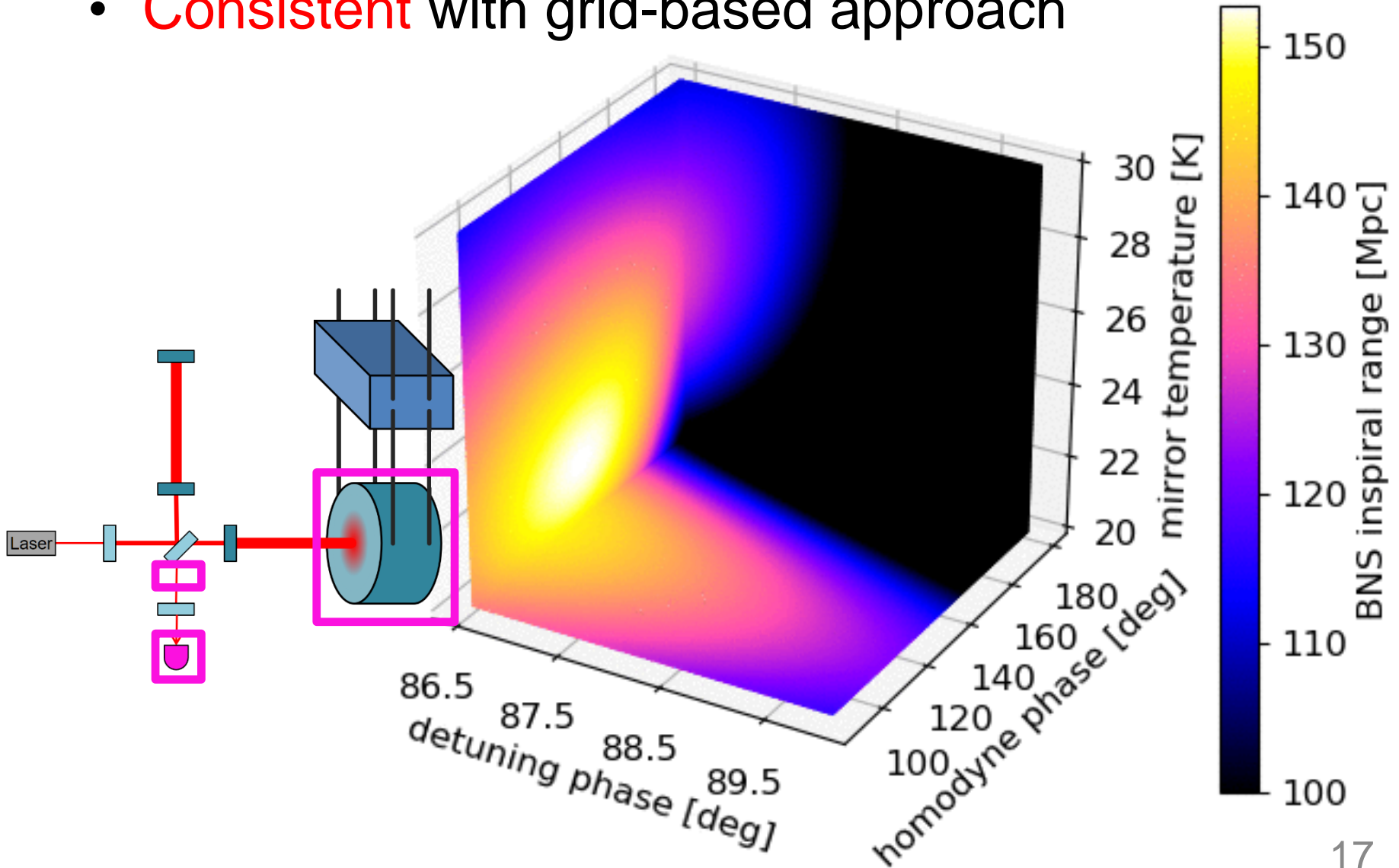

# 3 Parameter Optimization

- Consistent with current designed sensitivity optimized with grid-based approach

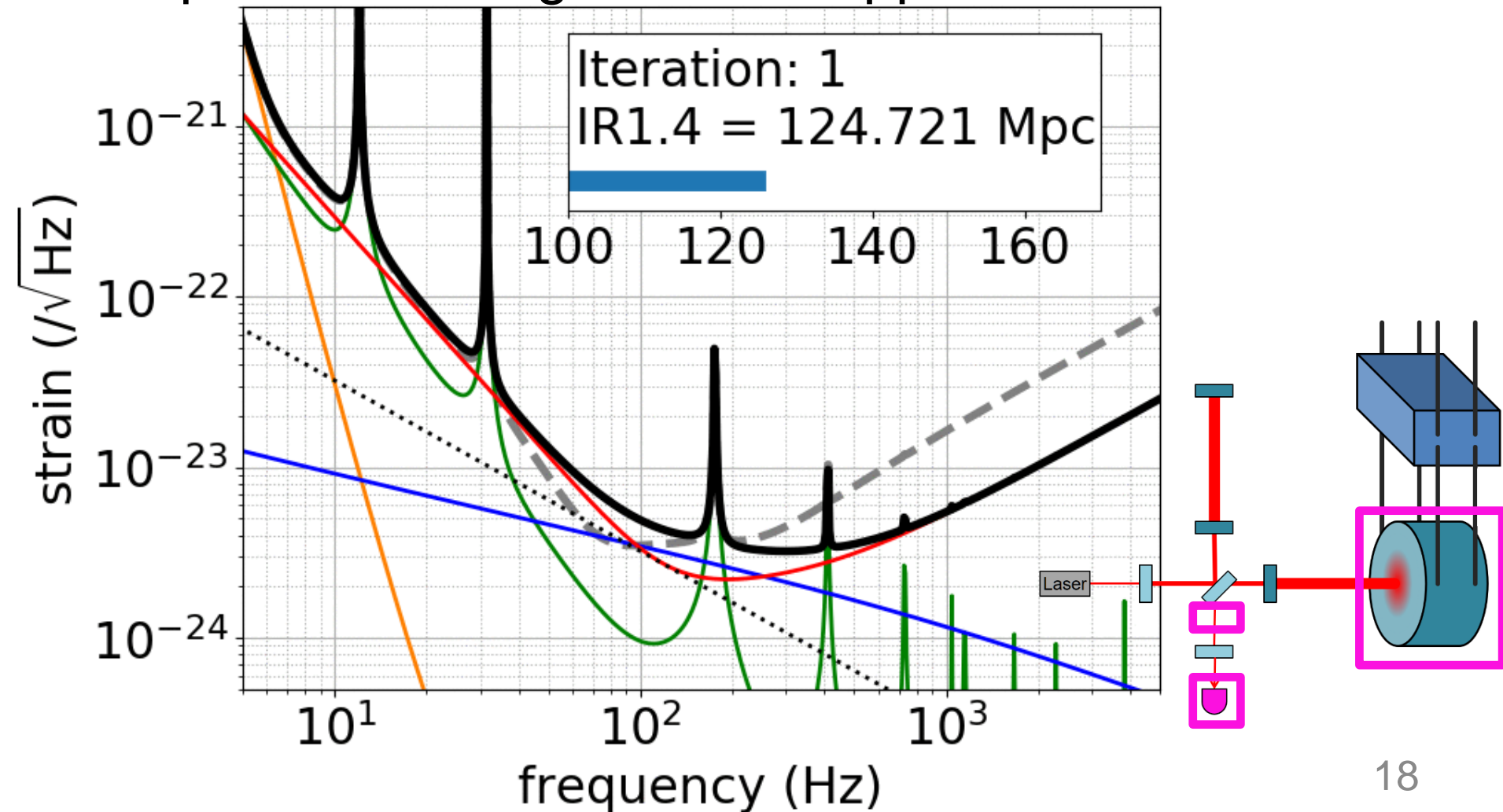

# 3 Parameter Optimization

- Consistent with current designed sensitivity optimized with grid-based approach

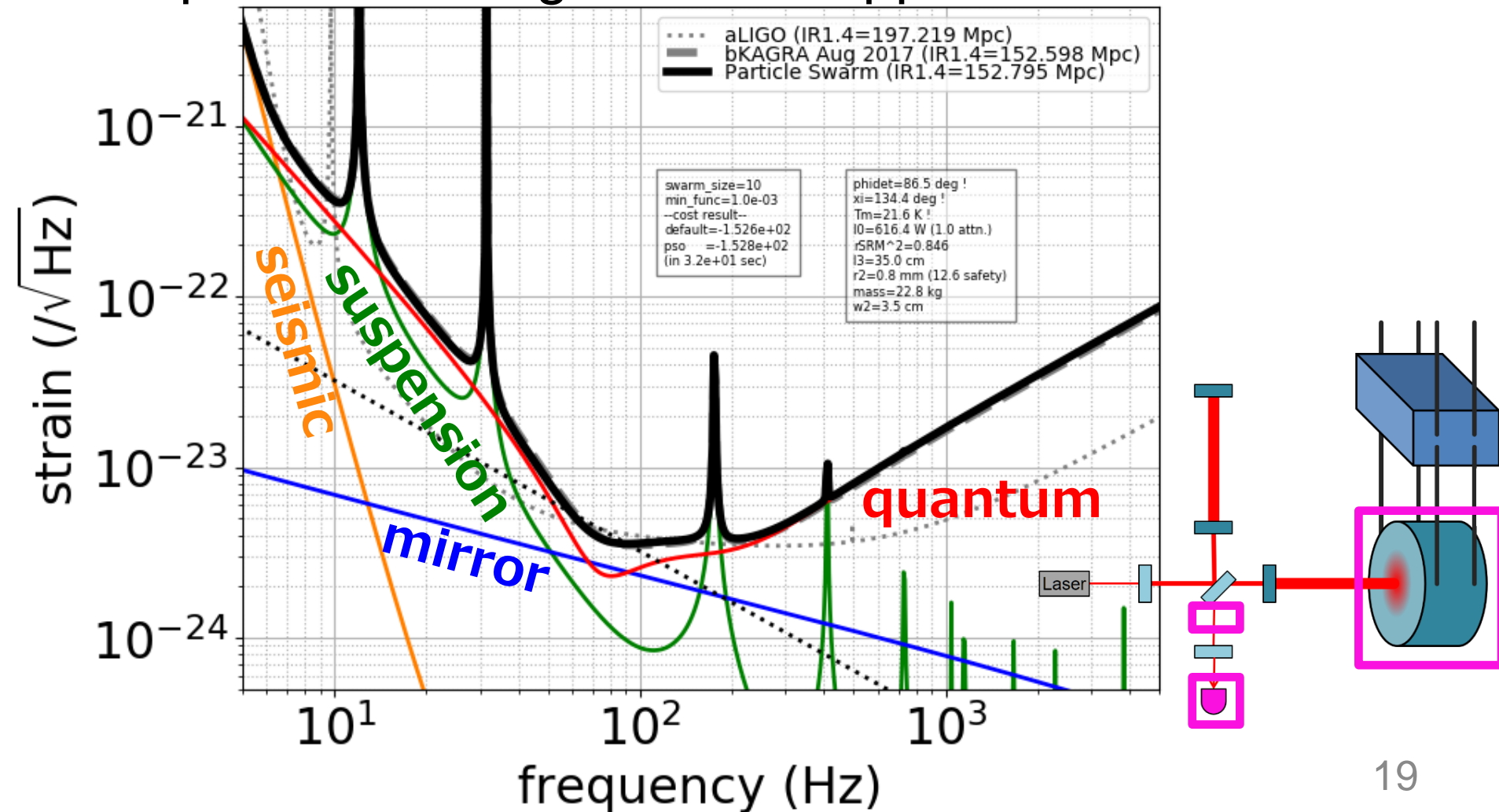

# 7 Parameter Optimization

- Changing suspension fibers and SRM increases BNS IR from 153 Mpc to 169 Mpc (10% increase)

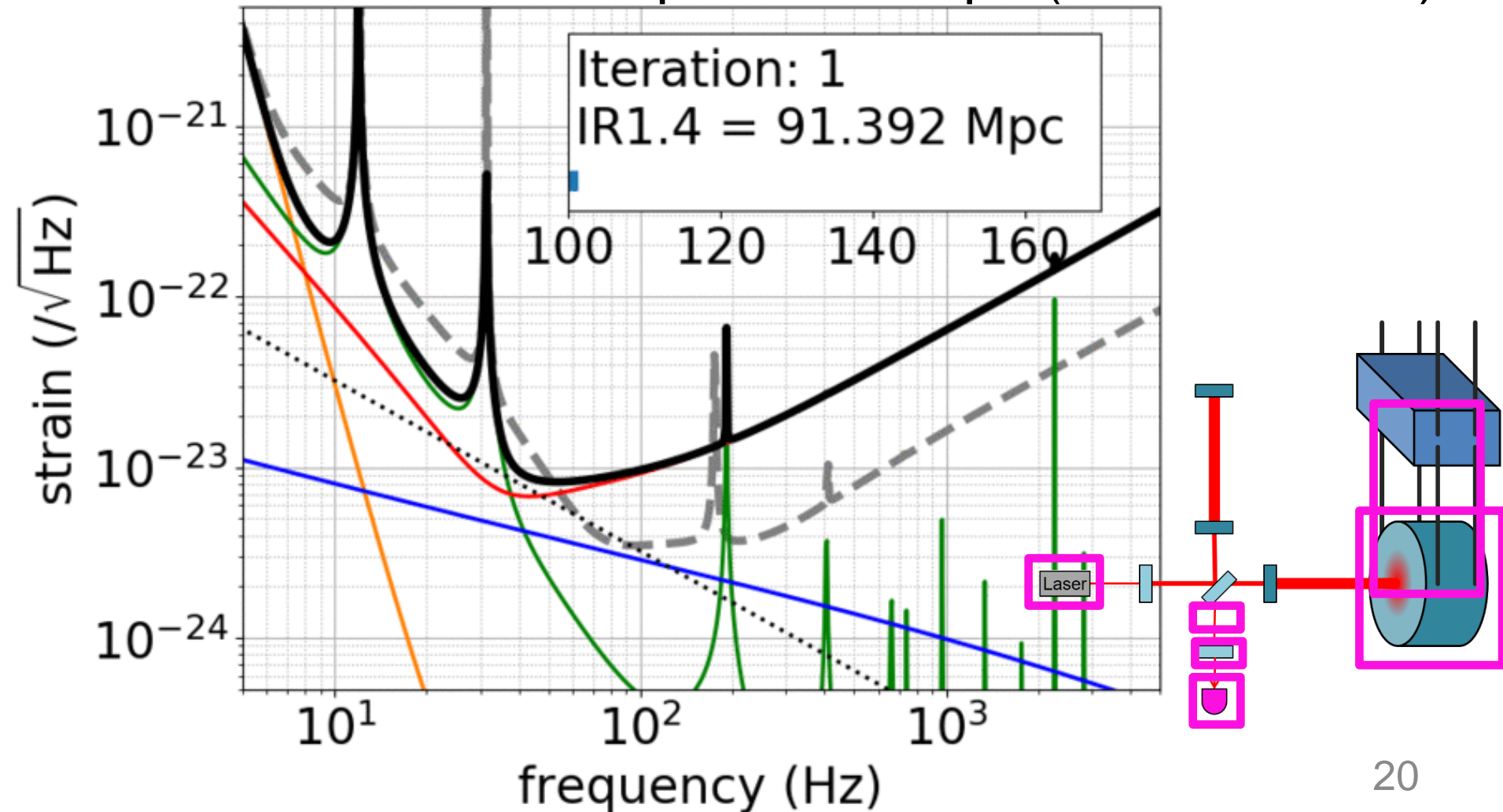



# 7 Parameter Optimization

- Changing suspension fibers and SRM increases BNS IR from 153 Mpc to 169 Mpc (**10% increase**)

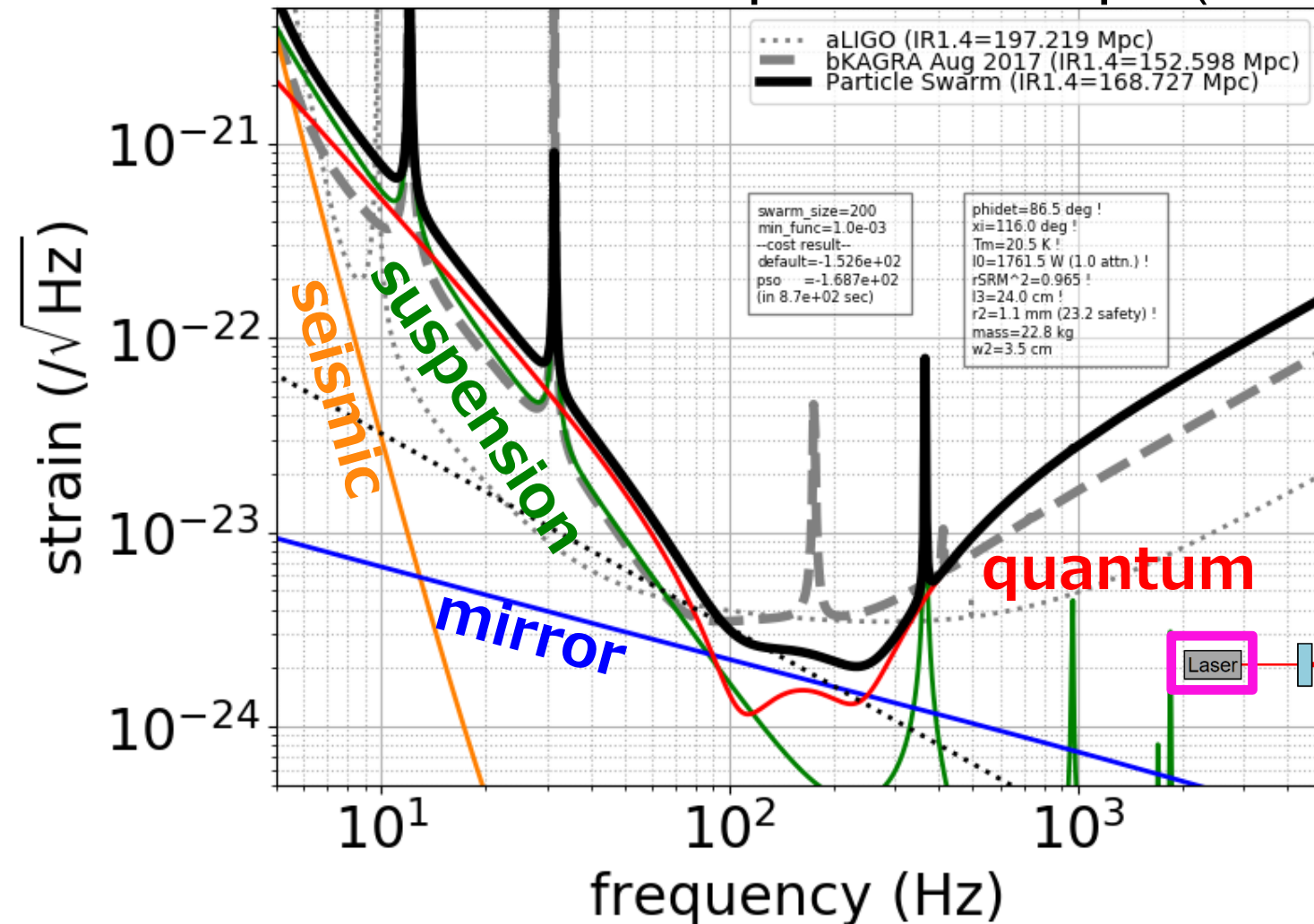

shorter and thicker to put more power with 20 K (min)

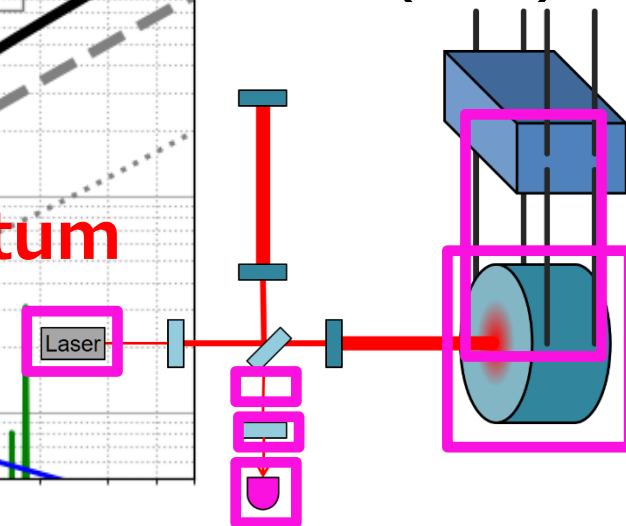

# Sensitivity Design with PSO is Fast

- Optimization done in **O(10) minutes** with my laptop
- Number of cost function evaluations

	Grid-based	PSO
3 params	$\sim 10^5$	$10 \times (52 \pm 13)$
5 params	$\sim 10^9$	$20 \times (73 \pm 16)$
7 params	$\sim 10^{14}$	$200 \times (60 \pm 18)$

\* In case optimization is done at precision of 0.1 Mpc

- Computational cost **do not grow exponentially** with dimensionality of parameter space
- **Useful** for optimization with many parameters, computationally expensive cost function

# Sky Localization Optimization

- Cost function:
  - **sky localization** of **GW170817**-like binary
    - 1.25-1.5 Msun at 40 Mpc, inclination 28 deg
    - zero spins, no precession
    - **108 sets** of sky location and polarization angle to derive median of sky localization error

- **Fisher matrix** to estimate the error

- inspiral waveform to
  - 3.0 PN in amplitude
  - 3.5 PN in phase
- 11 binary parameters

- **HLVK** global network

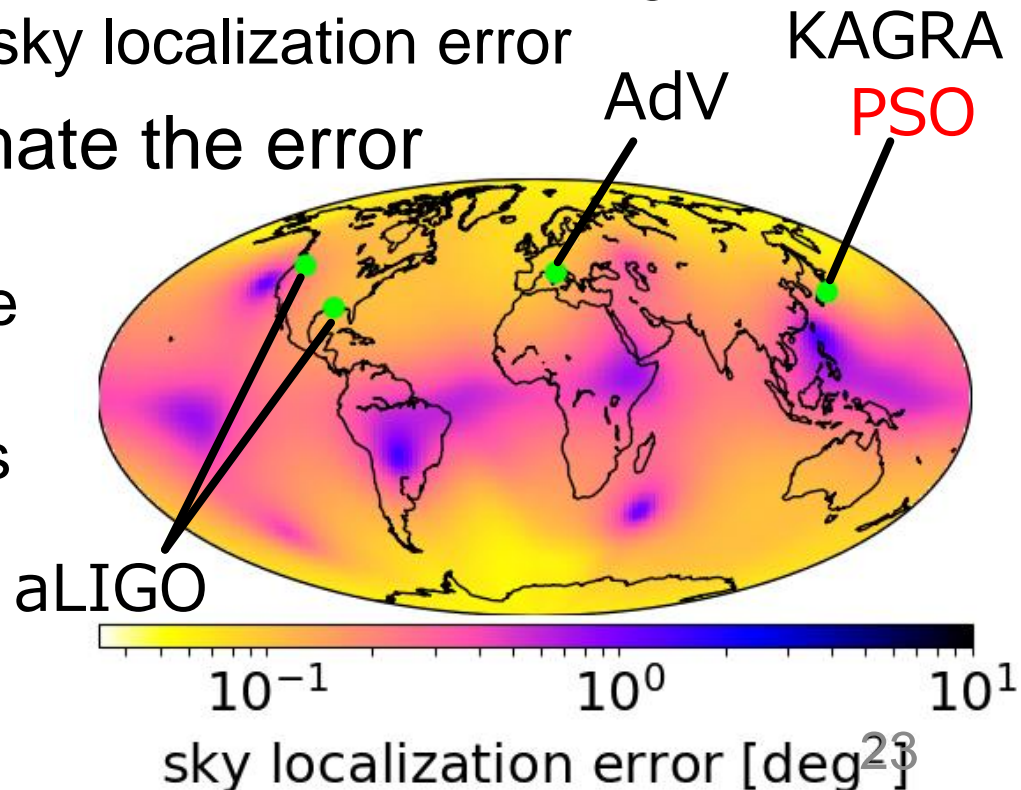

# 3 Parameter Optimization

- Sky localization improved by a factor of 1.3  
but inspiral range is reduced by 20%

0.18 deg<sup>2</sup>  
→ 0.14 deg<sup>2</sup>

2600 W at BS  
30 K

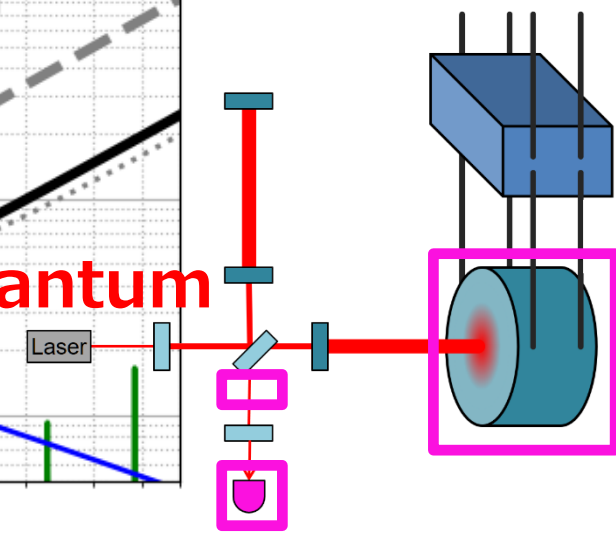
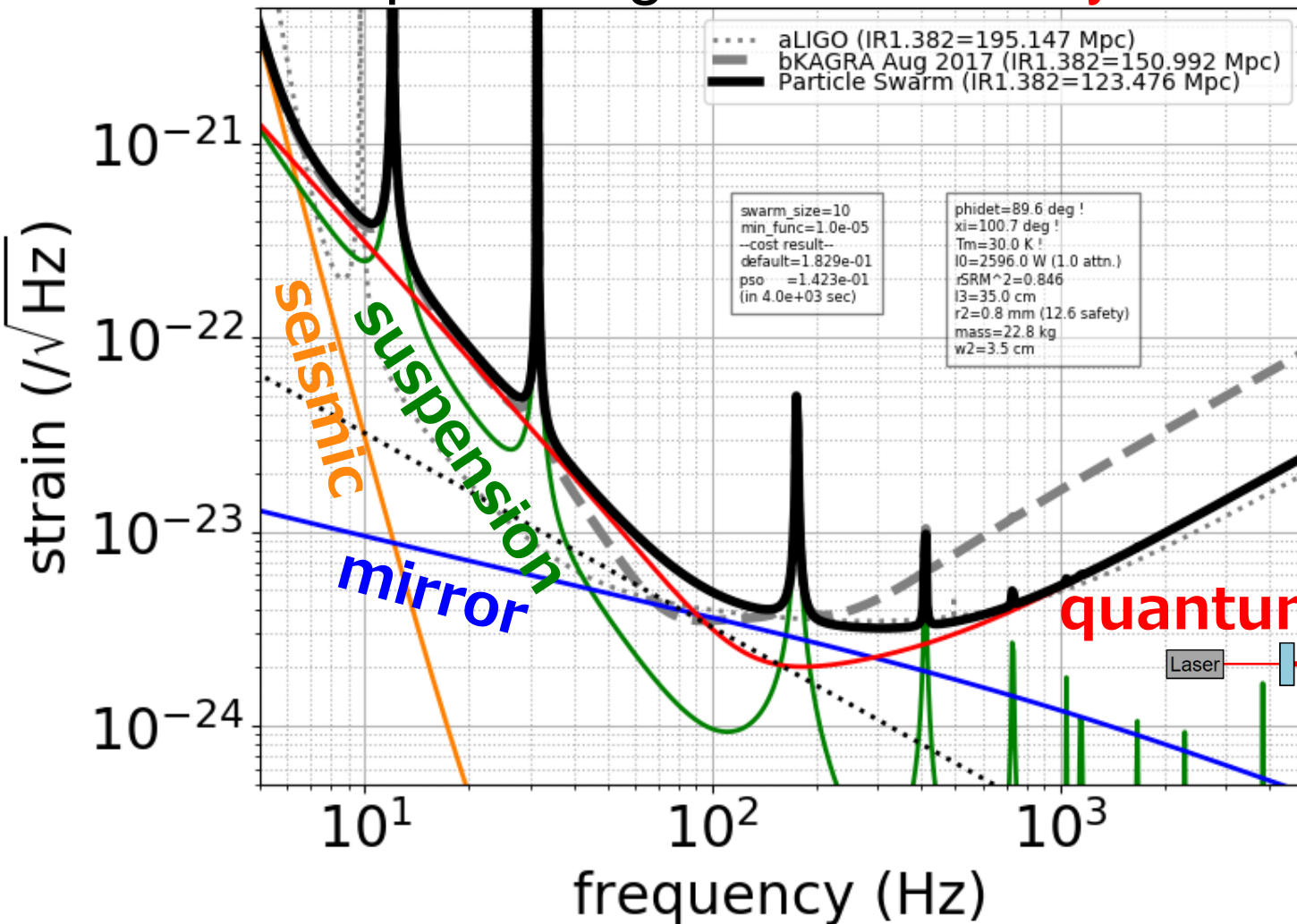



# 7 Parameter Optimization

- Sky localization improved by a factor of 1.6  
but inspiral range is reduced by 2%

0.18 deg<sup>2</sup>  
→ 0.11 deg<sup>2</sup>

shortest and  
thickest fibers  
1.1 kW at BS  
27 K

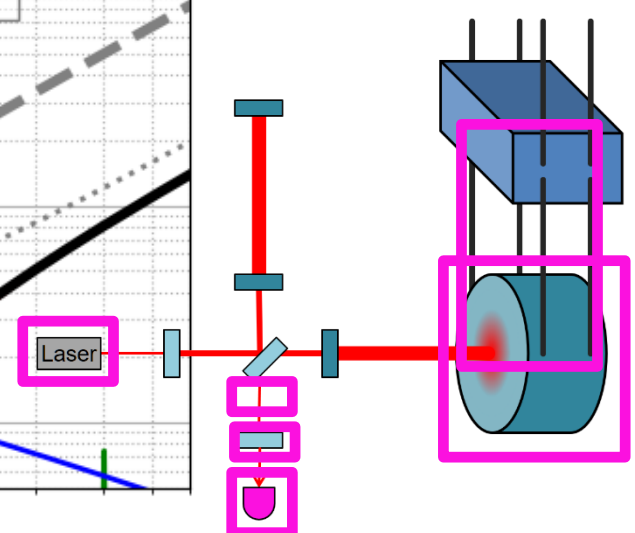
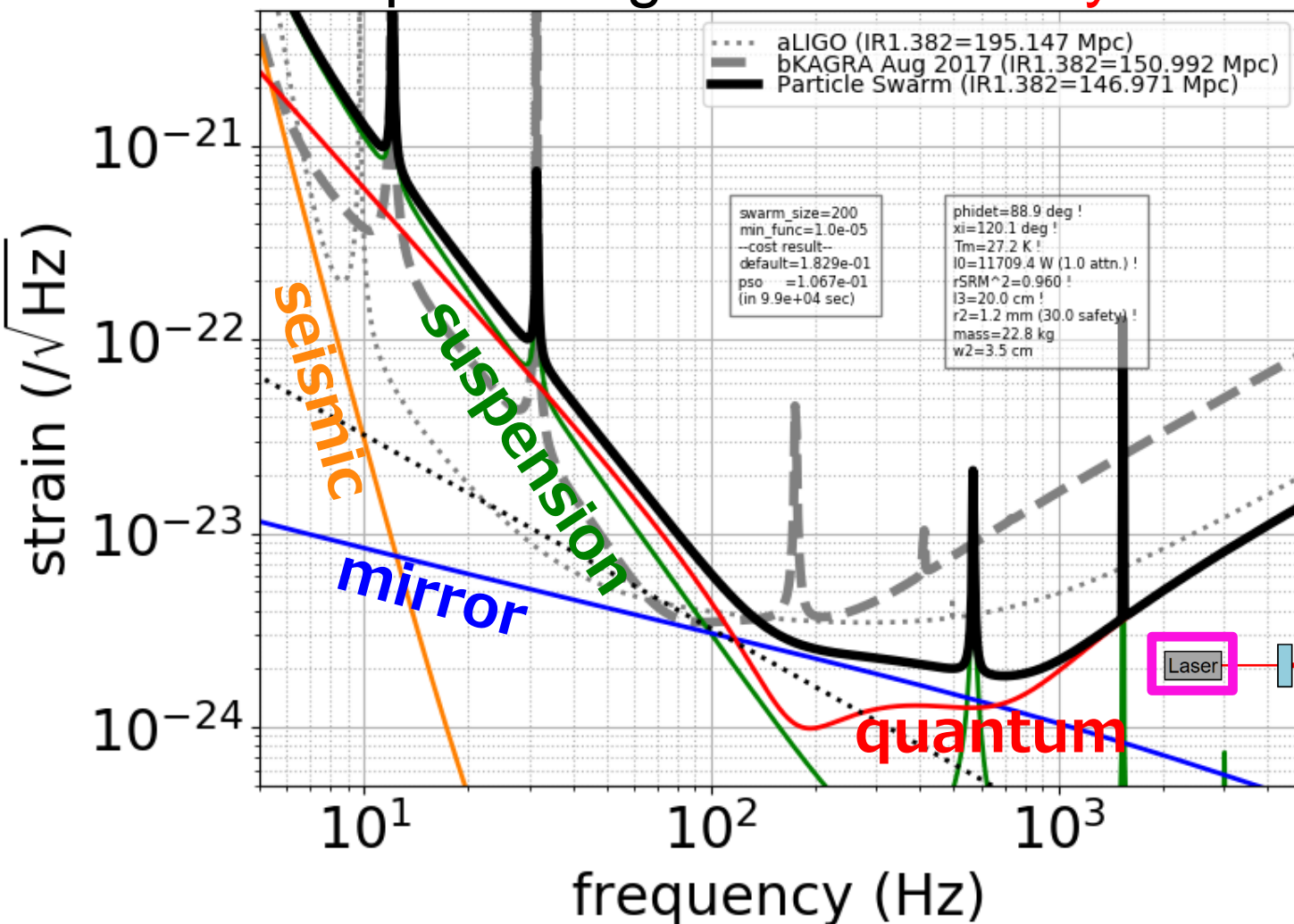

# Summary of Strategy Difference

- BNS inspiral range optimization

- **high detuning**,
- high SRM reflectivity
- shorter and thicker fiber
- **lower temperature** to keep mirror thermal low

- BNS sky localization optimization

- **no detuning**,
- high SRM reflectivity
- shorter and thicker fiber
- **higher temperature** to put more laser power

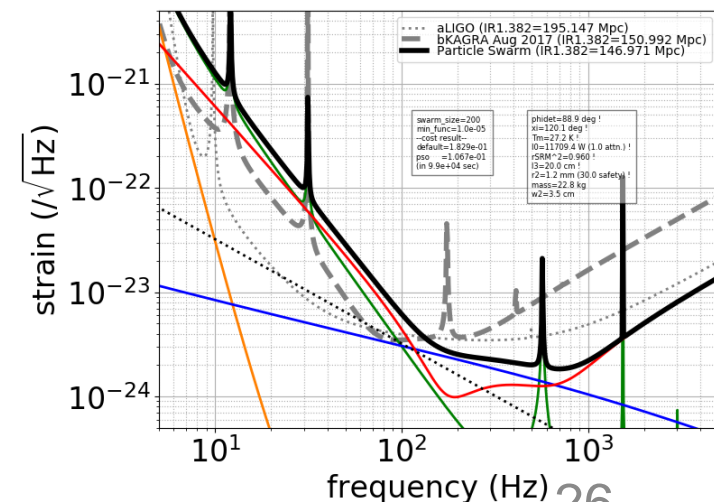
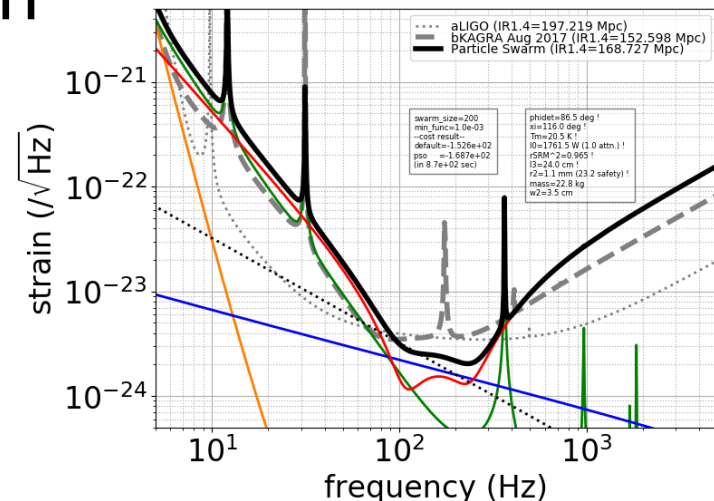

# Future Prospects

- Optimize **intermediate mass** parameters
- Incorporate squeezing and more **complicated** quantum techniques

- Incorporate **detection rate** into cost function
- **Global network** optimization
- Optimization for NS EoS, BH ringdown, non-GR polarization etc...

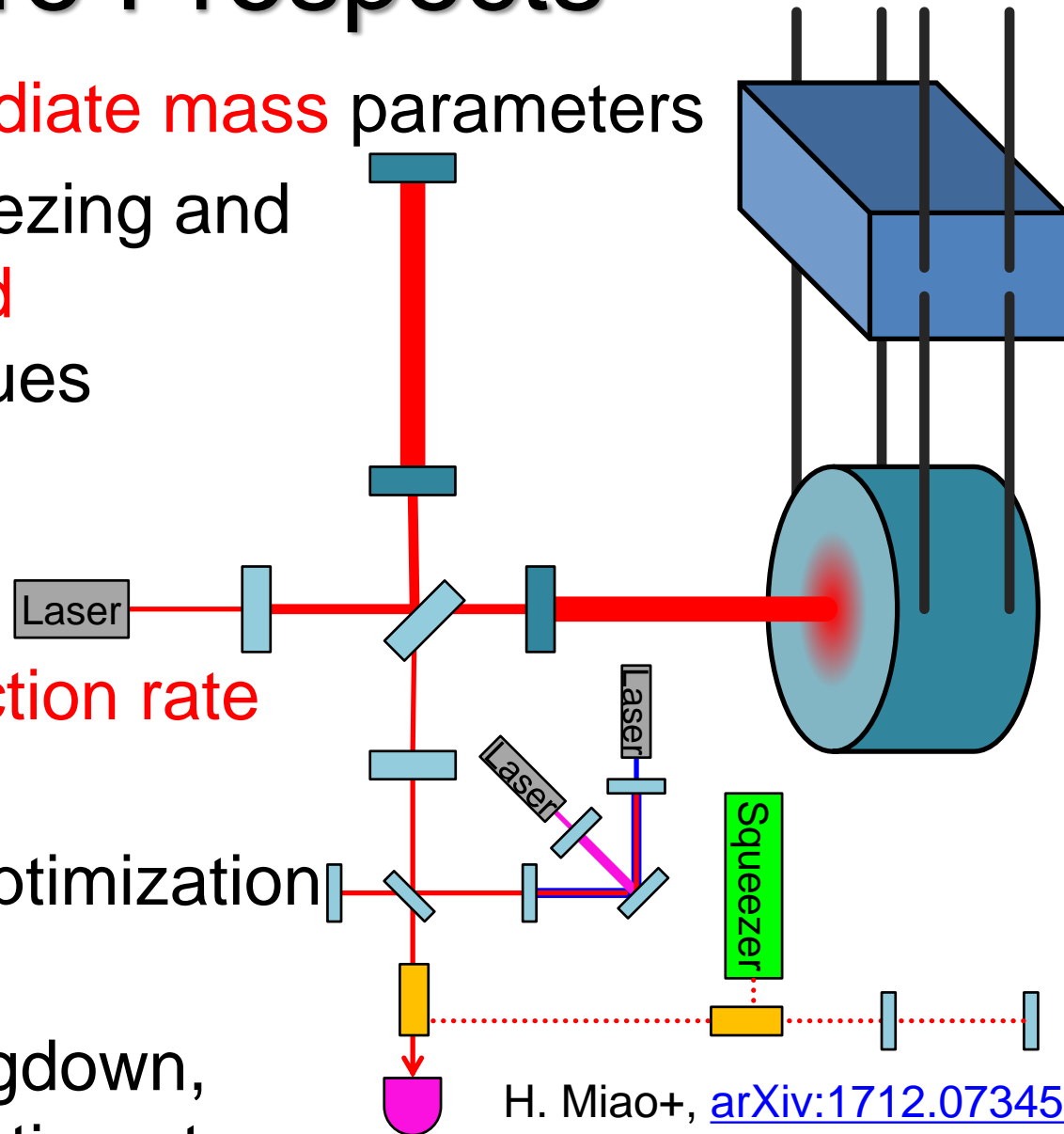

H. Miao+, [arXiv:1712.07345](https://arxiv.org/abs/1712.07345)

# Summary

- Demonstrated sensitivity design with **PSO**
- Application to KAGRA shows
  - BNS **inspiral range** can be **increased by 10 %**
  - BNS **sky localization** can be **improved by 1.6**by retuning 7 parameters of existing components
- Showed that PSO is **useful** for future GW detectors
  - low computational cost
  - little prior information necessary
  - allows more sophisticated cost function
- YM+ [arXiv:1804.09894](https://arxiv.org/abs/1804.09894)

# Supplementary Slides

# Pyswarm

- Python package **Pyswarm** was used for this work

<https://pythonhosted.org/pyswarm/>

<https://github.com/tisimst/pyswarm/>

- PSO as easy as

```
xopt, fopt = pso(func, lb, ub)
```

optimal parameter set      optimal cost function      cost function      lower and upper bounds

# Other Optimization Methods

- Simulated annealing  
tuning cooling schedule is troublesome
- Genetic algorithm  
too many design variables
- Markov chain Monte Carlo  
tend to be dependent on prior distribution  
gives error from posterior distribution  
takes time
- Machine learning  
if the problem well-modeled,  
you don't need ML

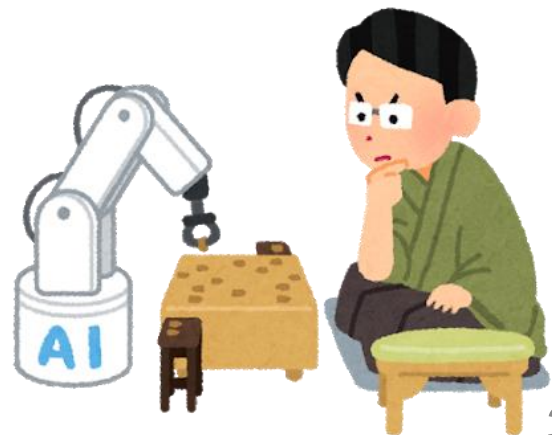

# Swarm Size Determination

- **Probability of convergence**: ratio of PSO trials resulted within 0.1 Mpc or  $10^{-3}$  deg<sup>2</sup>
- Increased swarm size until probability of convergence is larger than **90%**

number of params	3	5	7
number of particles	10	20	200
number of iterations	$52 \pm 13$	$73 \pm 16$	$60 \pm 18$
probability of convergence	98 %	96 %	91 %

\* From 100 PSO trials



# IFO Parameter Search Range

	Lower bound	Upper bound	KAGRA Default	Precision
Detuning angle [deg]	86.5 (or 60) *	90	86.5	0.1
Homodyne angle [deg]	90	180	135.1	3
Mirror temperature [K]	20	30	22	0.09
Power attenuation	0.01	1	1	0.02
SRM reflectivity	0.5	1	0.92 (85%)	6e-4
Wire length [cm]	20	100	35	0.02
Wire safety factor	3	30	12.57 (0.8 mm)	0.07

\* Considering SRC nonlinearity, maximum detuning is 3.5 deg  
(see Y. Aso+ [CQG 29, 124008](#))

- *Reflecting wall* boundary:  
 $x=x_{\max}, v=-v$  if  $x>x_{\max}$   
 $x=x_{\min}, v=-v$  if  $x<x_{\min}$

step size which changes  
BNS inspiral range by 0.1 Mpc



# Money

- Detuning angle and homodyne angle can be retuned without additional cost
- Mirror temperature and input power can be retuned without additional cost if power at BS is less than  $\sim 1$  kW ( $\sim 100$  W entering PRM)
- Change in SRM reflectivity require  $\sim 0.1$  Million USD
- Change in wire parameters require  $\sim 0.01$  Million USD/fiber
- Change in wire length additionally require test mass suspension design change at  $\sim 0.1$  Million USD/mirror
- Change in the test mass require  $\sim 0.6$  Million USD/mirror (more for heavier ones)

# Heavier Masses are Great

- BNS IR improves from 153 Mpc to 288 Mpc with 100 kg sapphire (with no coating improvement)

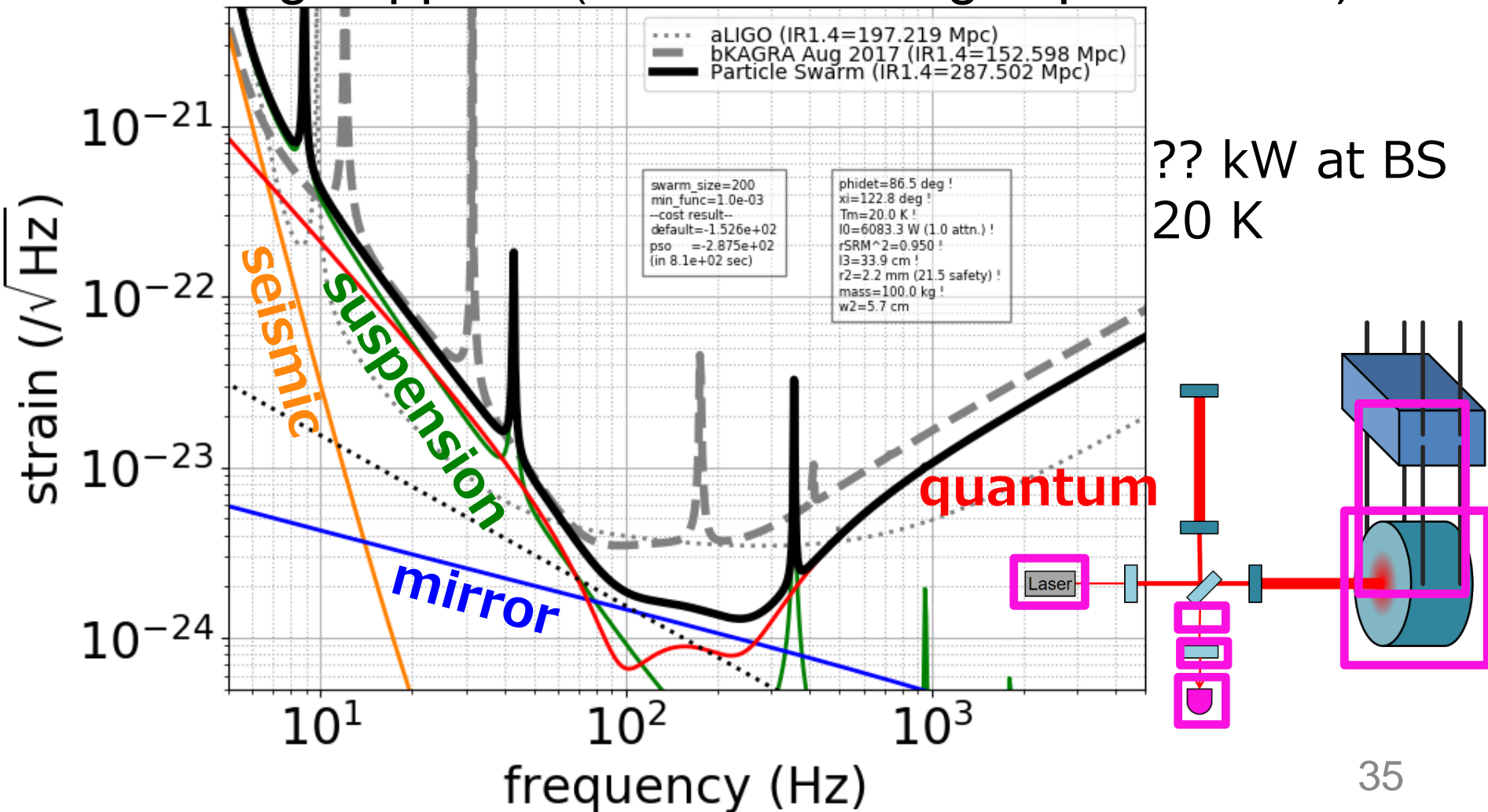

# Fiber Length and Diameter

- 25cm/ $\phi$ 1.4mm is optimum for BNS IR if other parameters are fixed (default: 35cm/ $\phi$ 1.6mm)

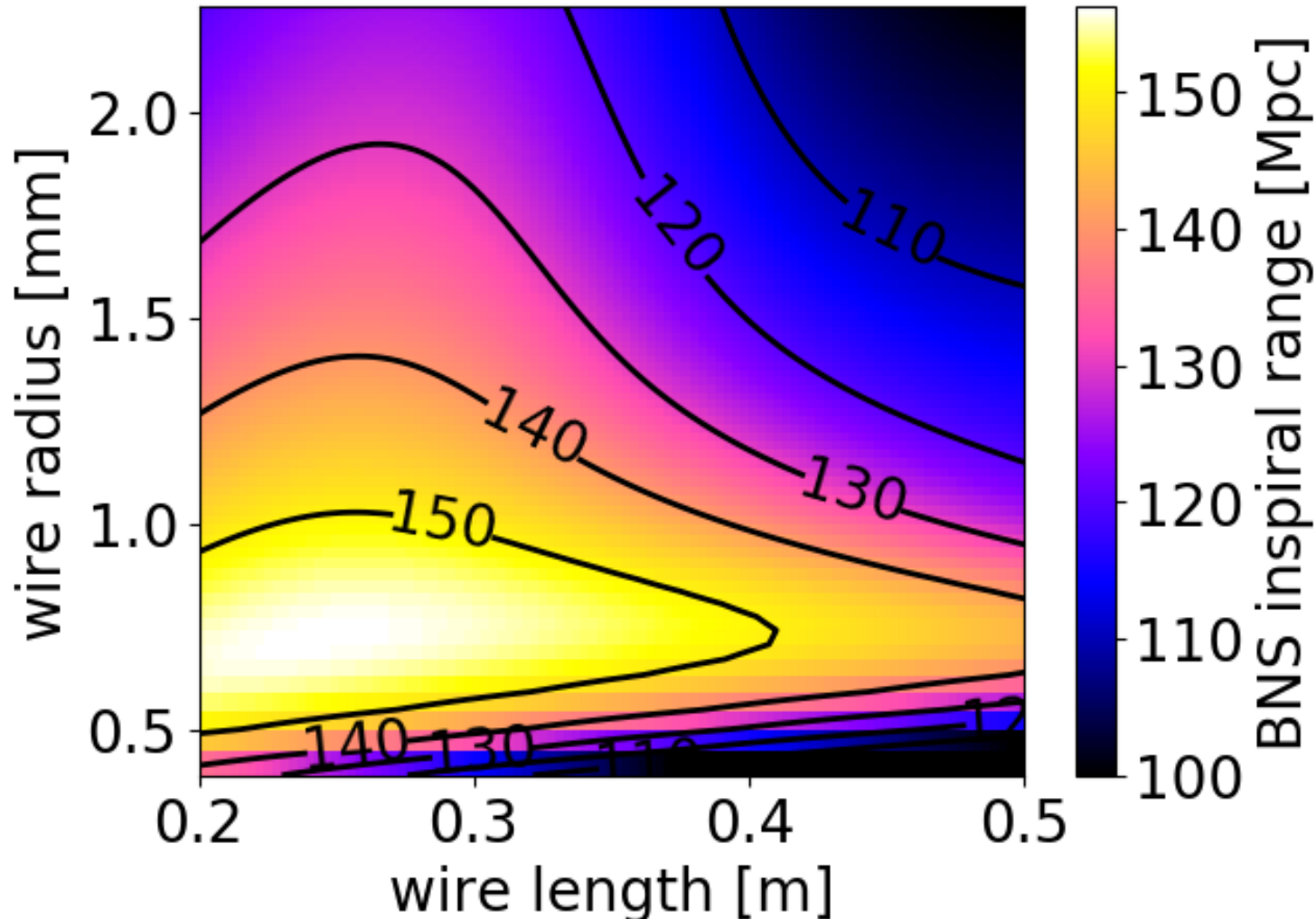

# Fisher Matrix Analysis

- Fisher matrix

$$\Gamma_{ij} = 4\Re \int_{f_{\min}}^{f_{\max}} \sum_k \frac{\partial h_k^*(f)}{\partial \lambda^i} \frac{\partial h_k(f)}{\partial \lambda^j} \frac{df}{S_{n,k}(f)}$$

- Covariance

$$\sqrt{\langle (\delta \lambda^i \delta \lambda^j) \rangle} = \sqrt{(\Gamma^{-1})^{ij}}$$

- 11 binary parameters considered

**mc**: chirp mass

**eta**: symmetric mass ratio

**tc**, **phic**: time and phase for coalescence

**dL**: luminosity distance

**chis**, **chia**: symmetric/asymmetric spin  $\chi_{s/a} = (\chi_1 \pm \chi_2)/2$

**thetas**, **phis**: colatitude / longitude of source

**cthetai**: inclination angle

**psip**: polarization angle

# Optimization for Fixed Sky Location

- Result for fixed sky location and polarization angle is **similar to sky average optimization**

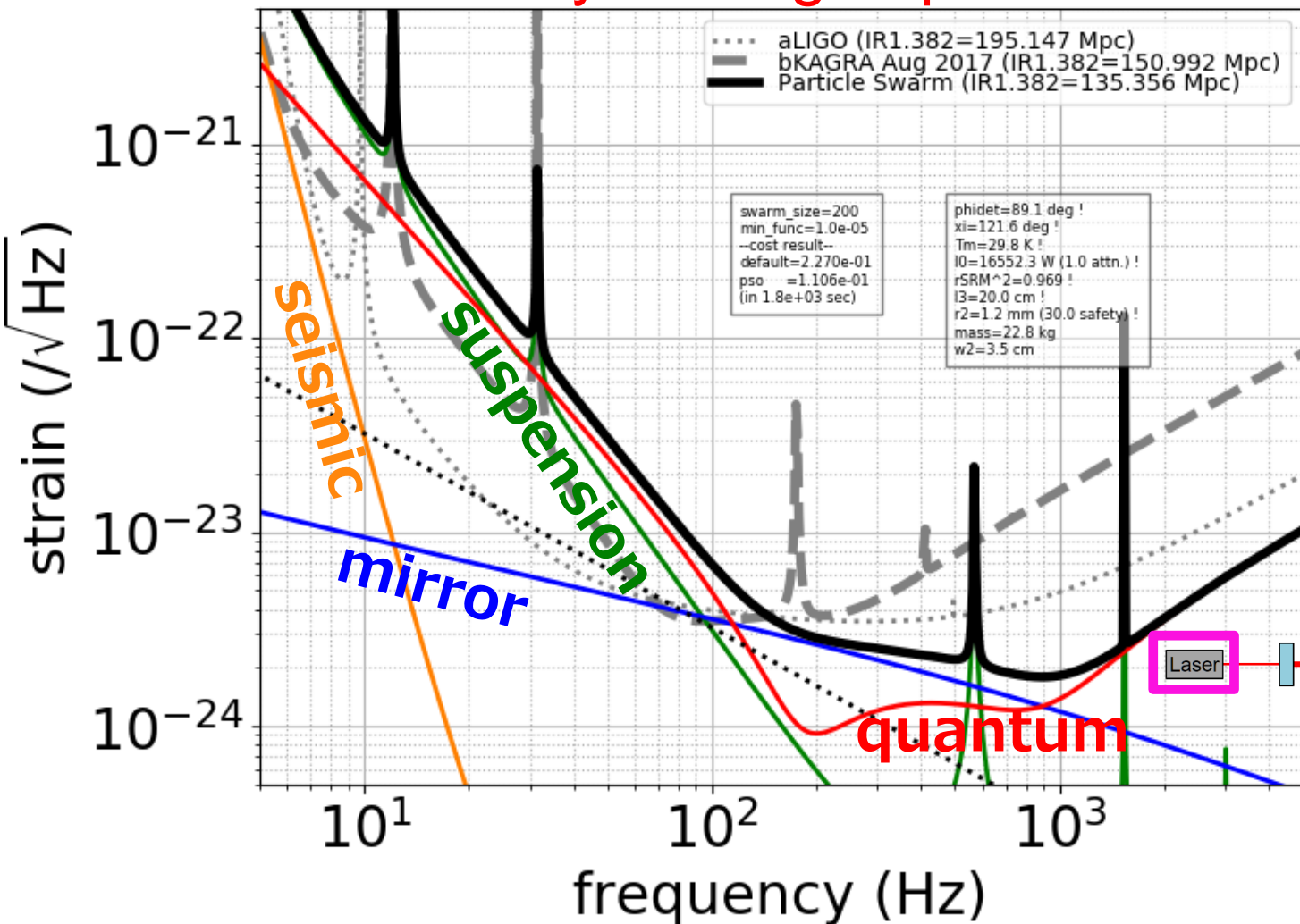

shortest and thickest fibers  
1.7 kW at BS  
30 K (max)

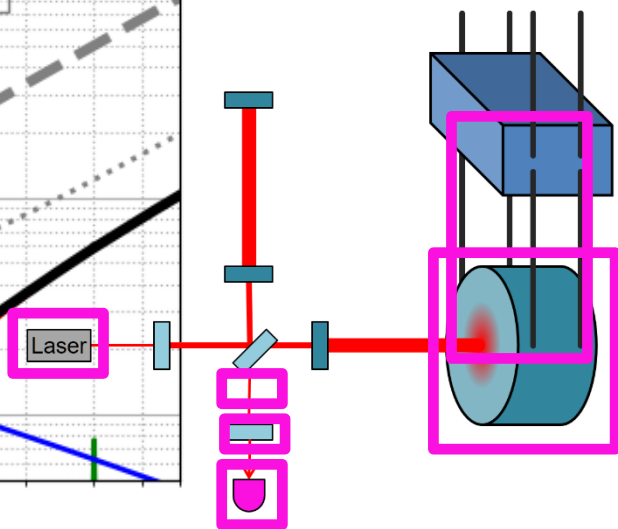



# Symmetric Spin Optimization

- Similar to sky localization optimization (focus on high frequencies)

$$\chi_s = \frac{\chi_1 + \chi_2}{2}$$

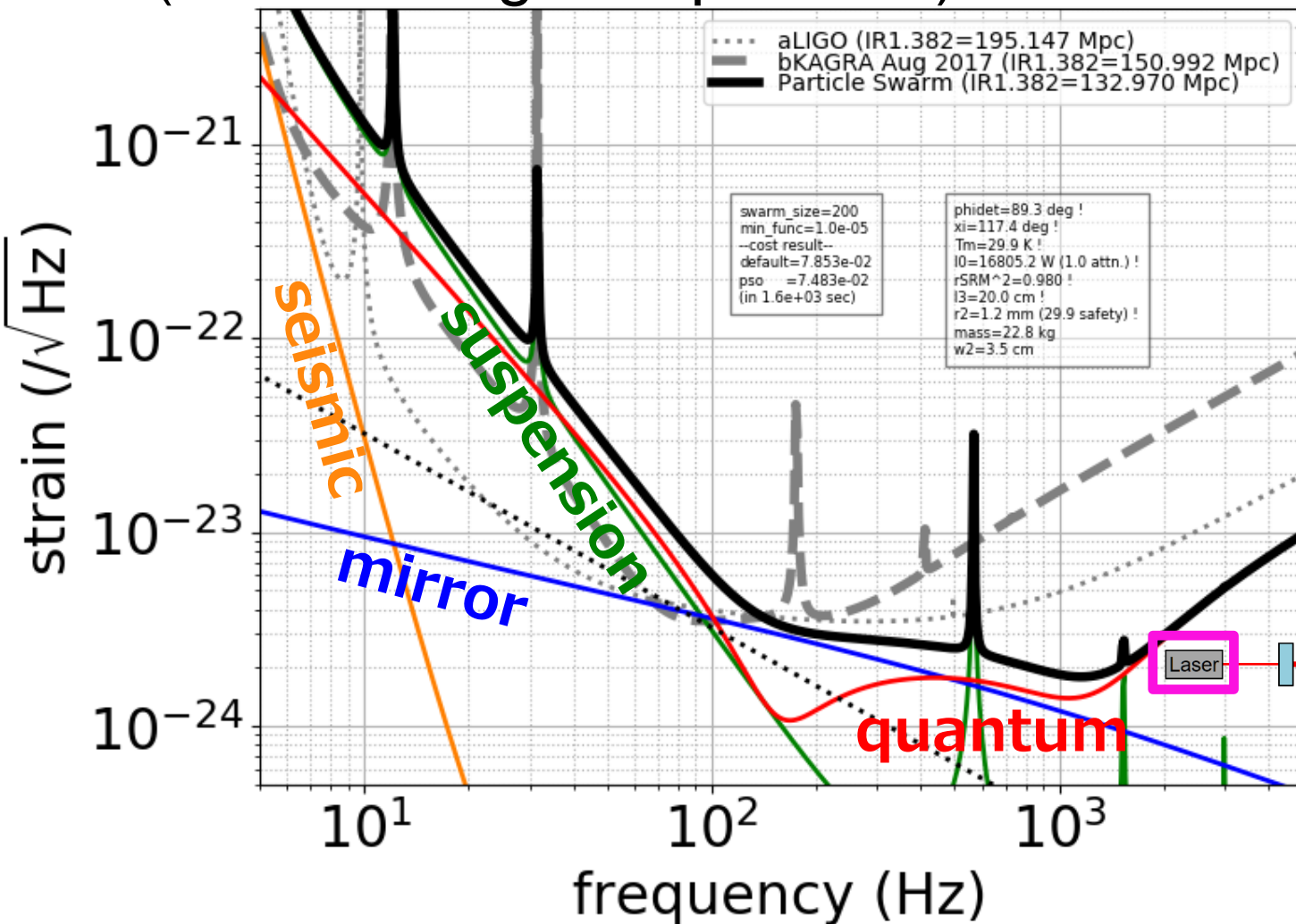

shortest and thickest fibers  
1.7 kW at BS  
30 K (max)

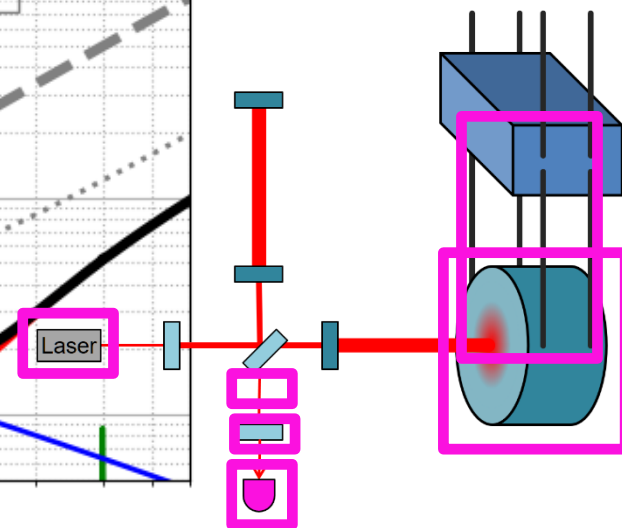

# Asymmetric Spin Optimization

- **Similar to sky localization** optimization (focus on high frequencies)

$$\chi_a = \frac{\chi_1 - \chi_2}{2}$$

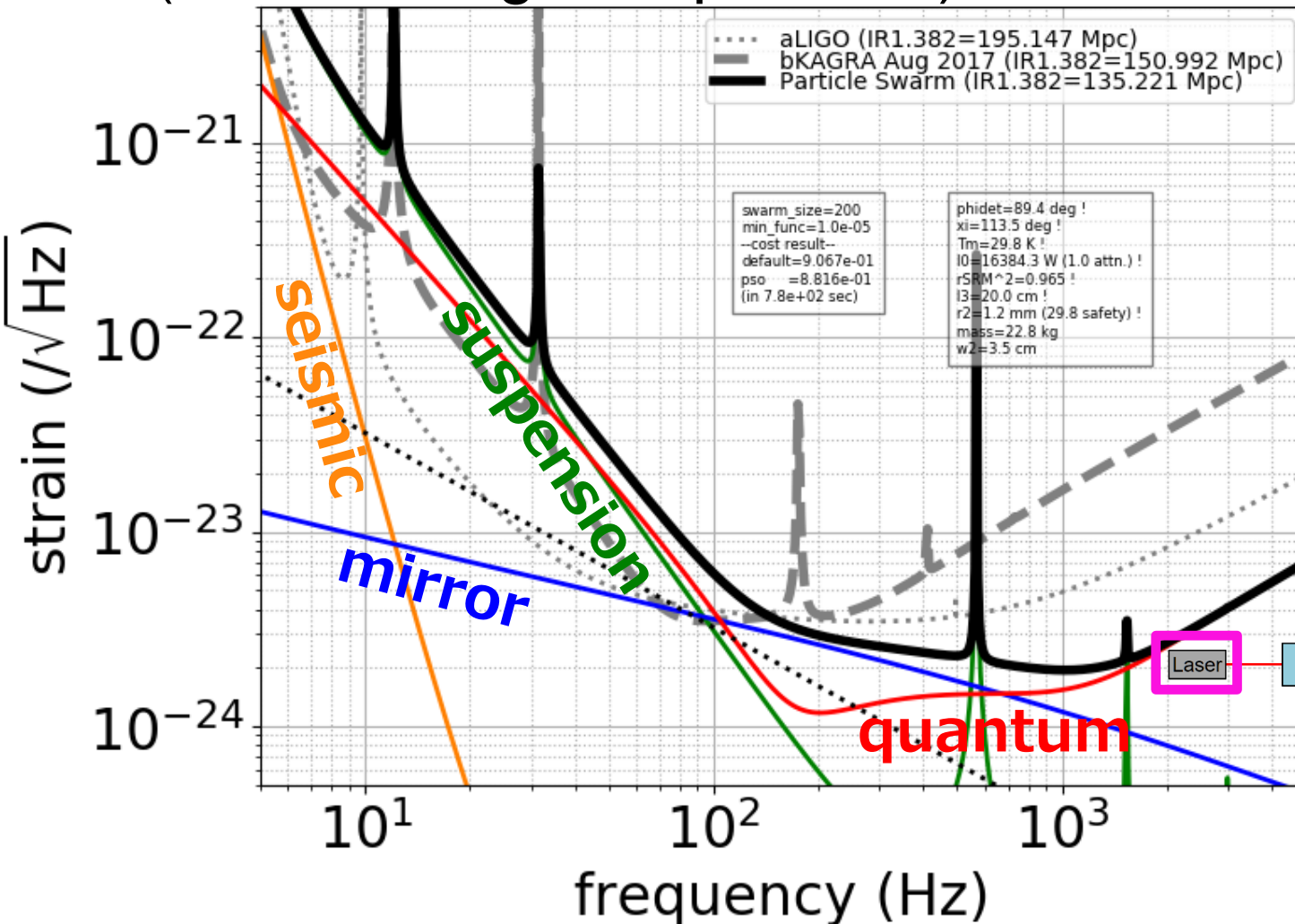

shortest and thickest fibers  
1.7 kW at BS  
30 K (max)

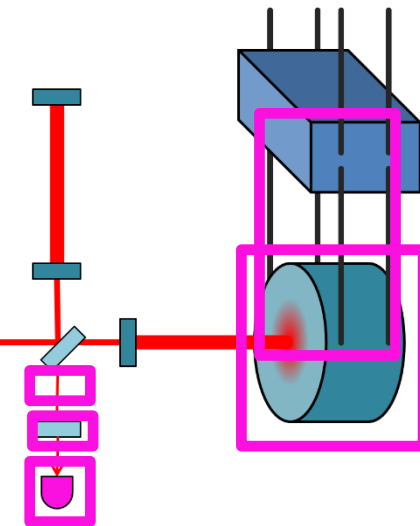



# Distance Optimization

- Similar to inspiral range optimization, but slight shift to high frequencies (slight improvement by 2%)

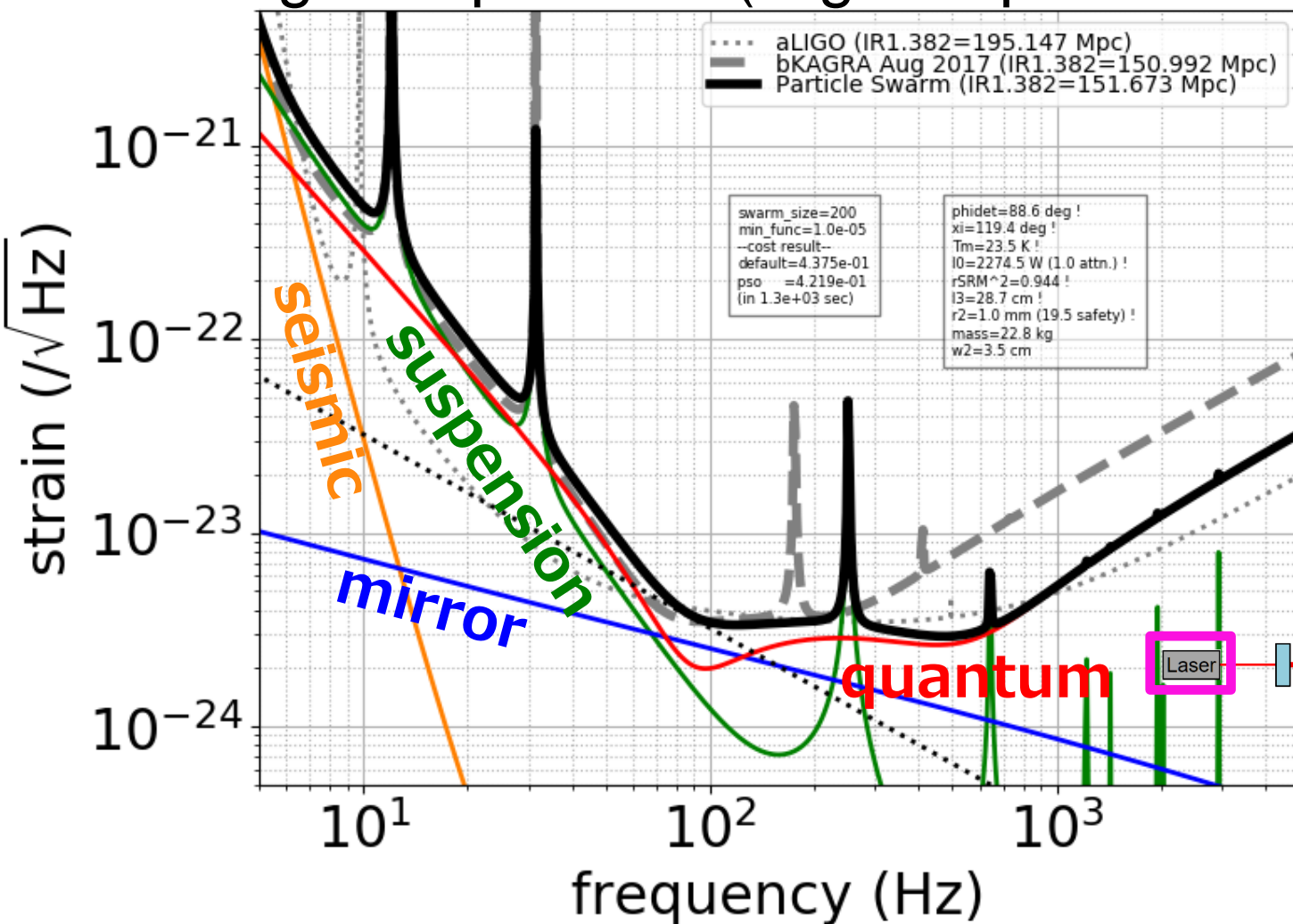

shorter and thicker fibers  
2.3 kW at BS  
24 K

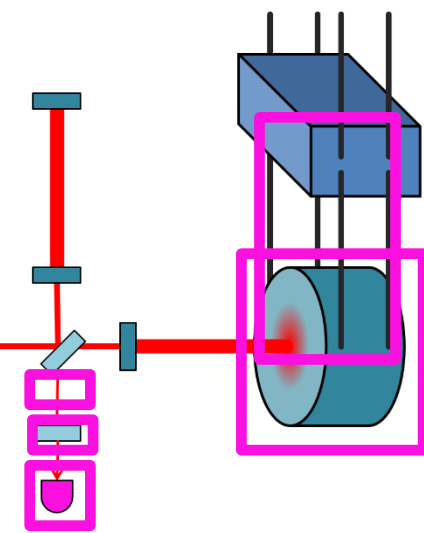

# Inclination Angle Optimization

- Similar to distance optimization (PE degeneracy)

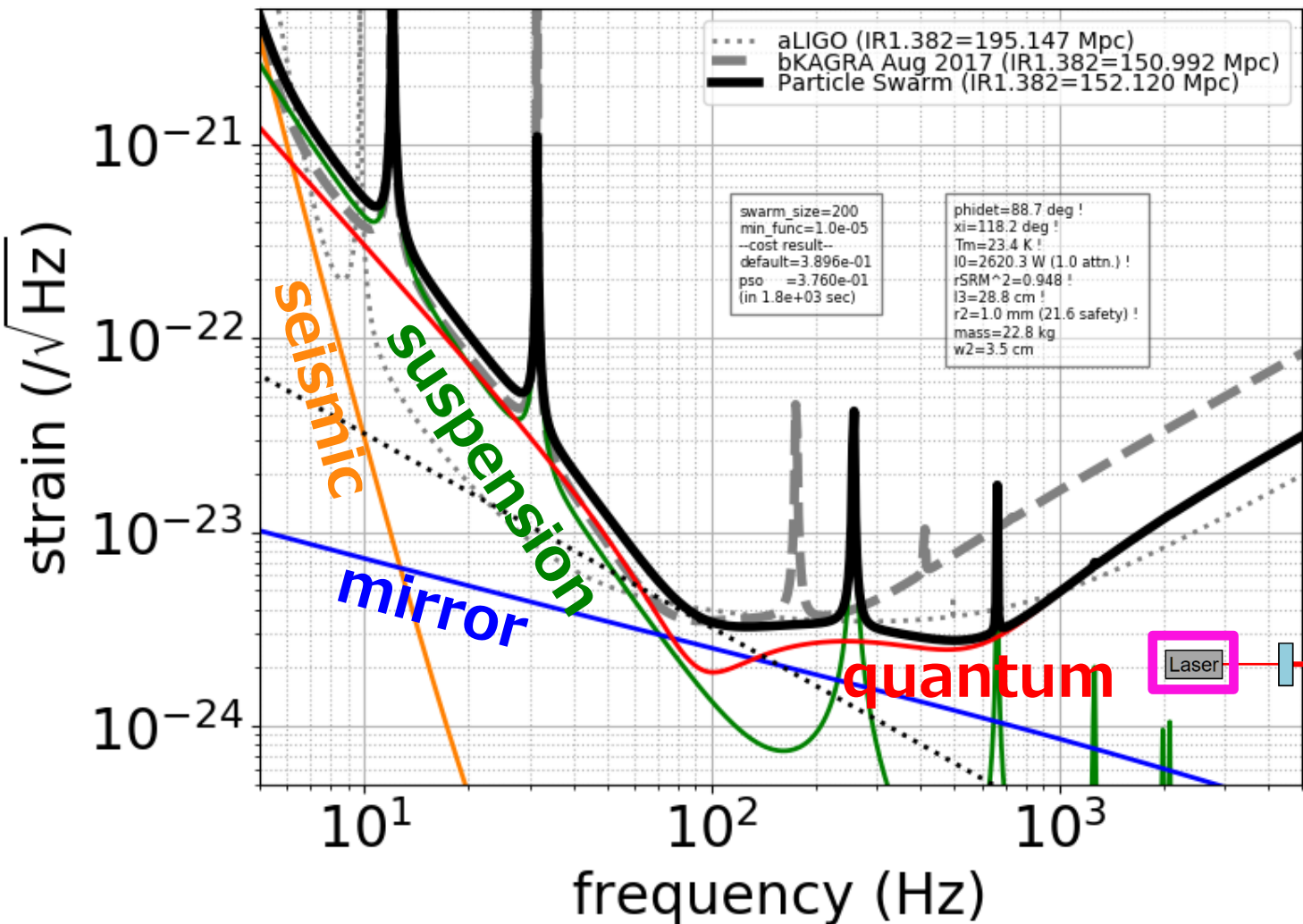

shorter and thicker fibers  
2.3 kW at BS  
24 K

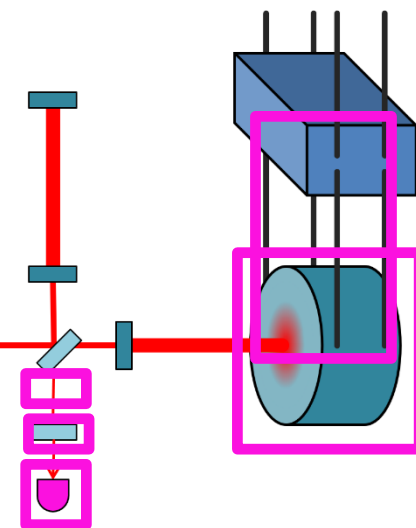

# BBH100 IR Optimization

- Low power, low temperature with thin and longer fibers (KAGRA+ **LF concept**)

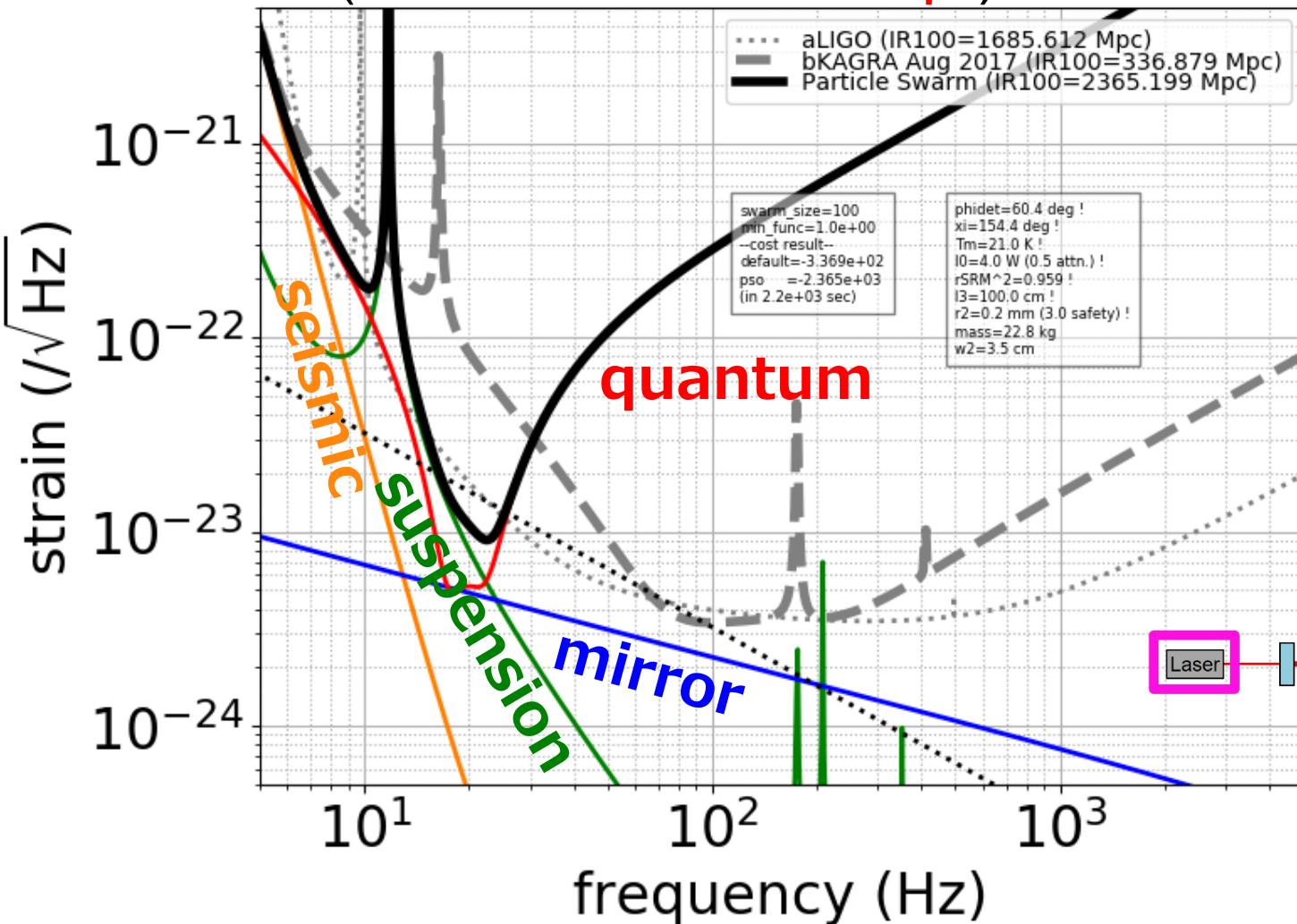

x4 heavier IM  
with thinner IM  
suspension  
Less ambient heat  
Allowed higher  
detuning

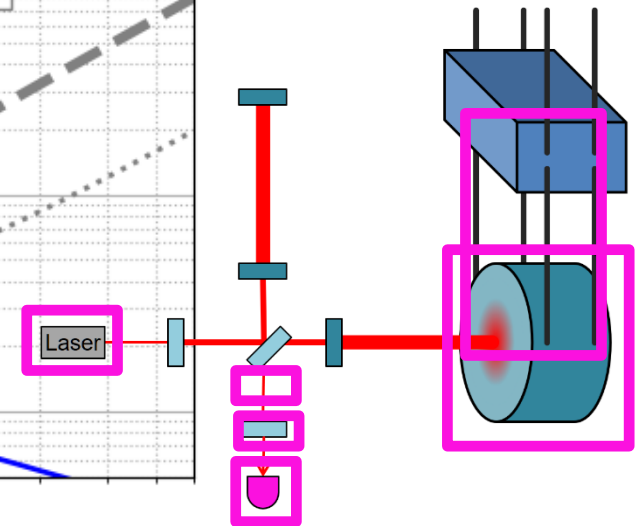

# Sky Localization with HLV

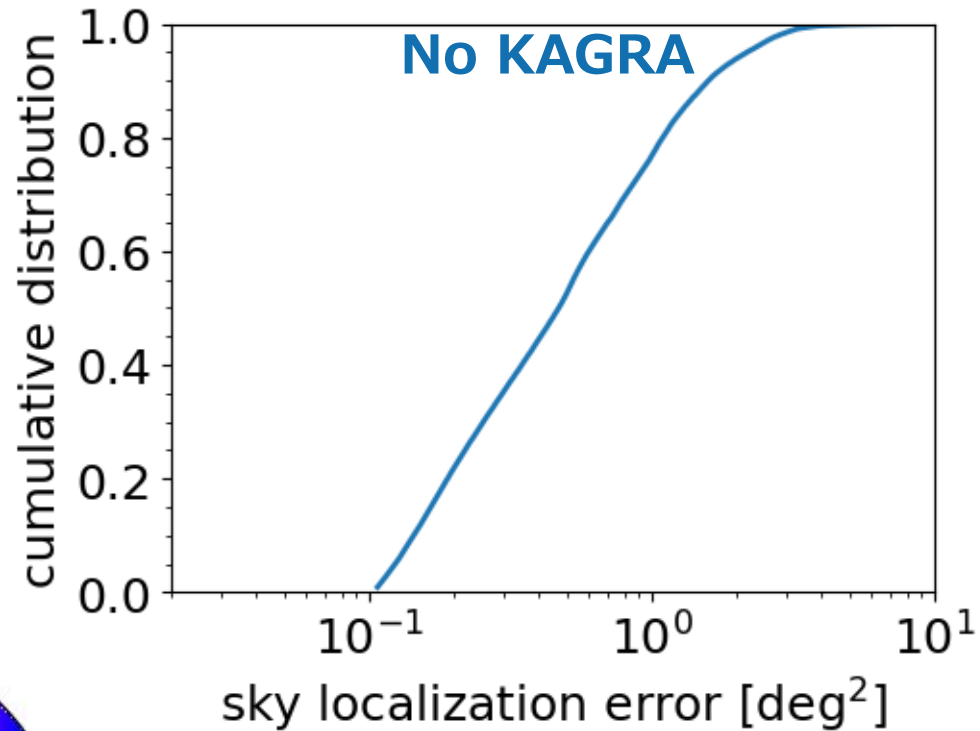
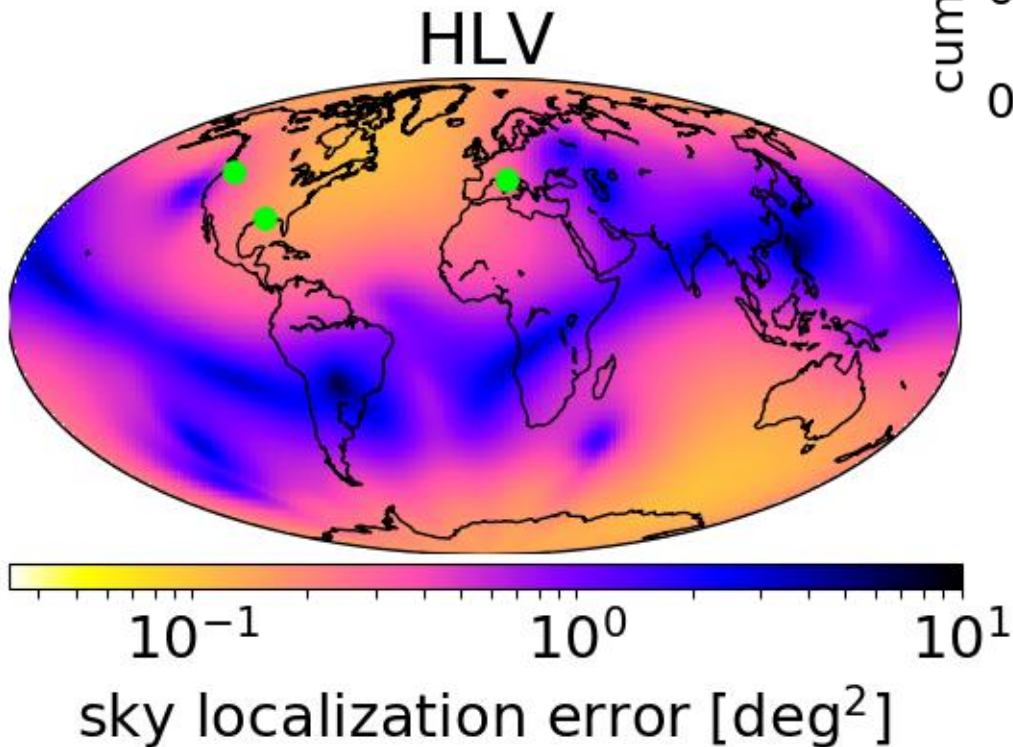

	median
HLV	0.472 deg <sup>2</sup>
HLVK	
HLVK+	



# Sky Localization with HLVK

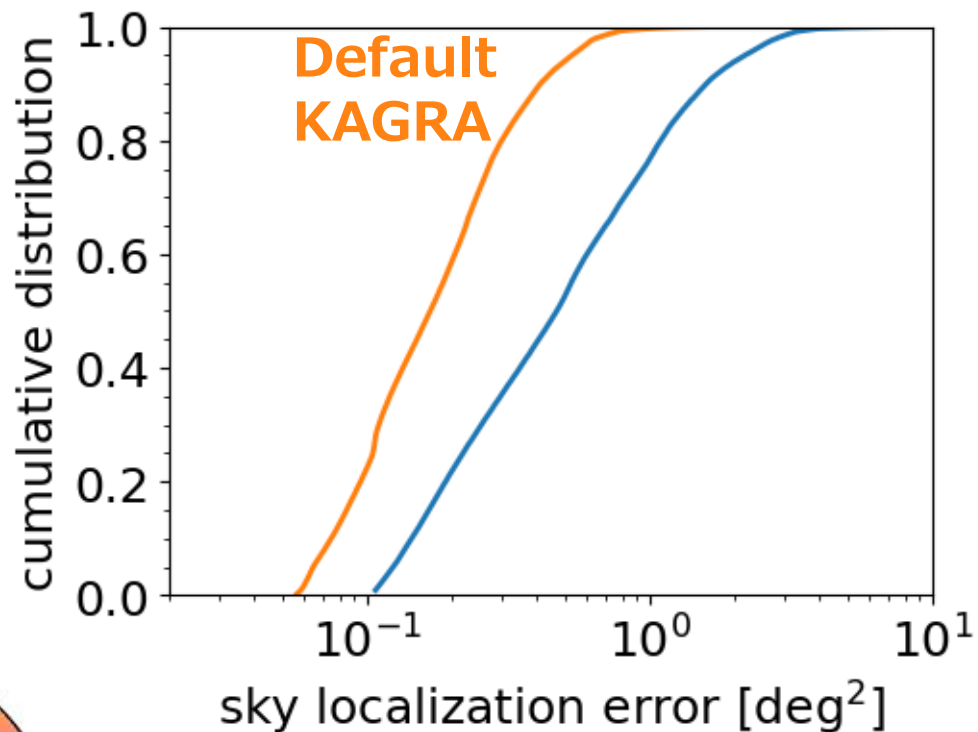
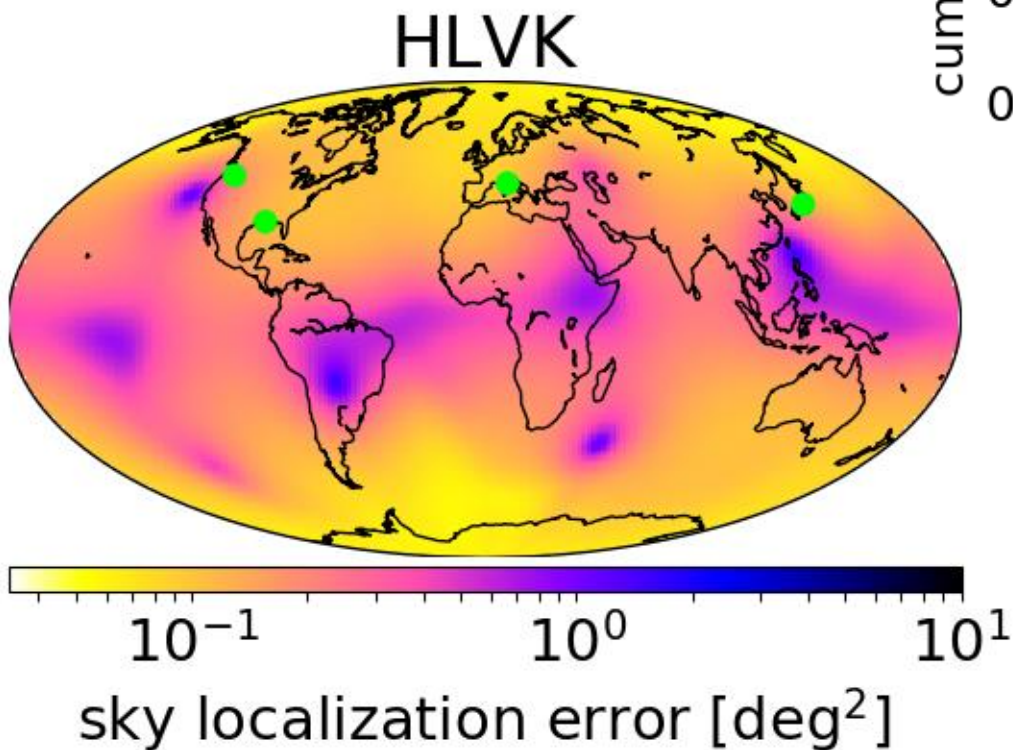

	median
HLV	0.472 deg <sup>2</sup>
HLVK	0.168 deg <sup>2</sup>
HLVK+	

# Sky Localization with HLVK+

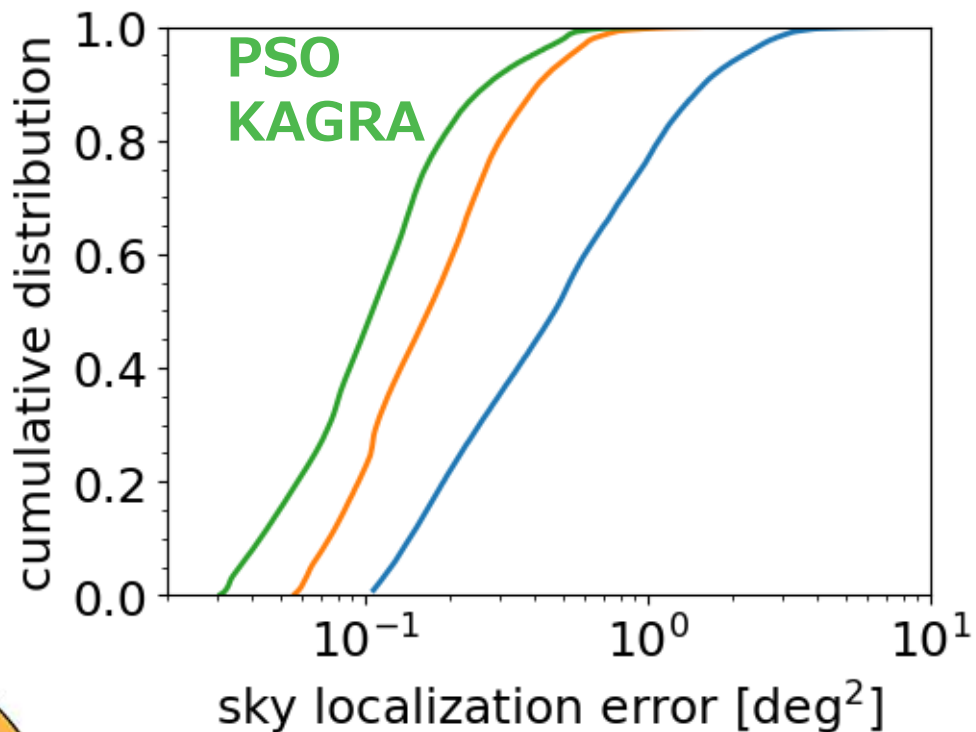
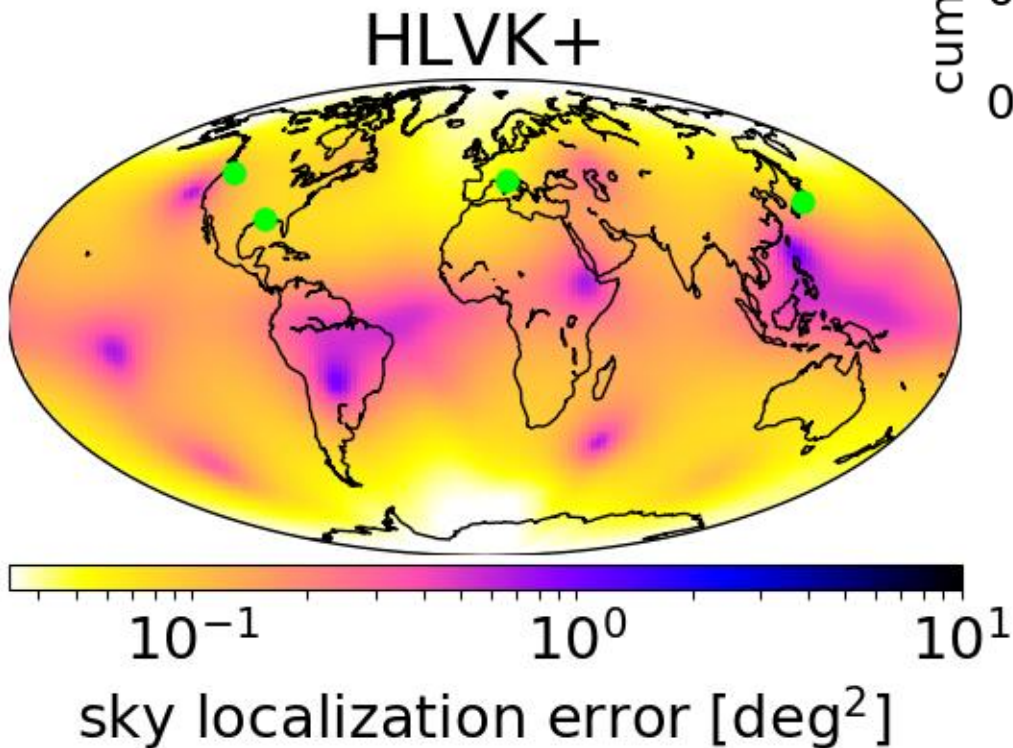

	median
HLV	0.472 $\text{deg}^2$
HLVK	0.168 $\text{deg}^2$
HLVK+	0.107 $\text{deg}^2$

# H Antenna Pattern L

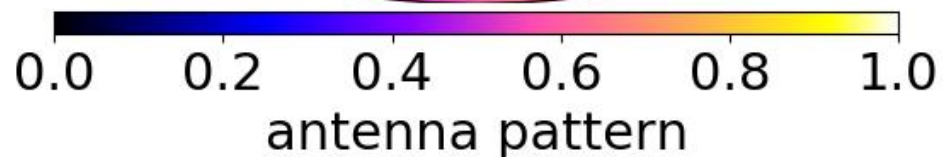
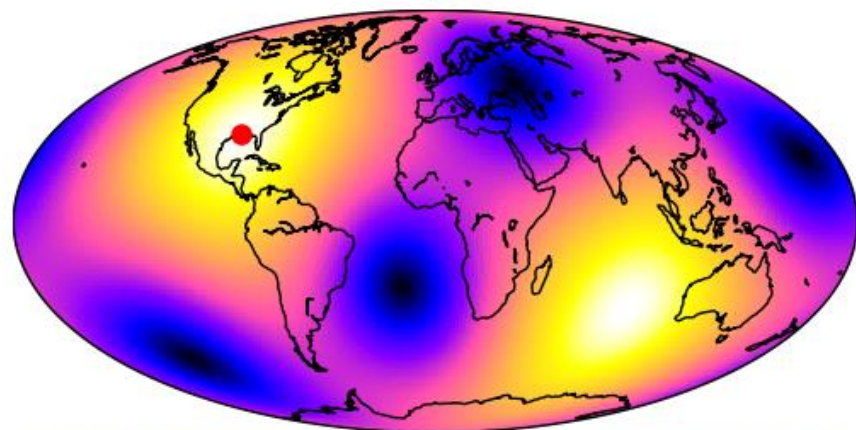
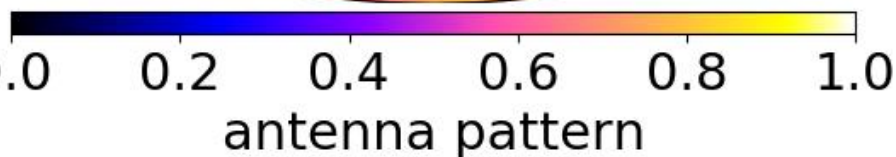
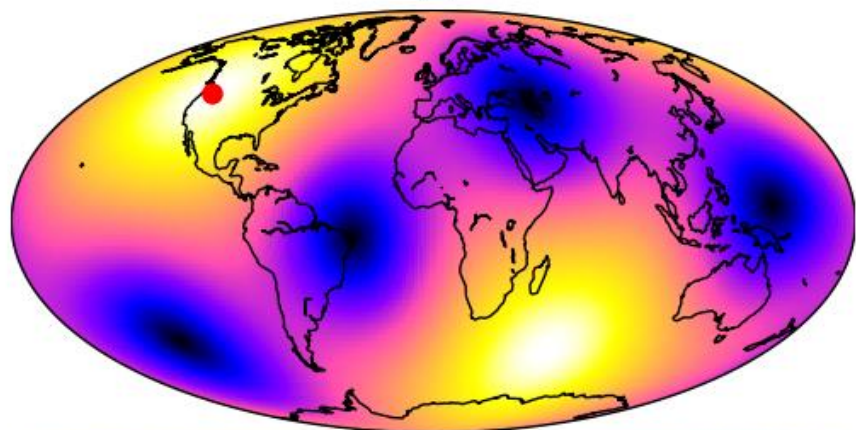

V

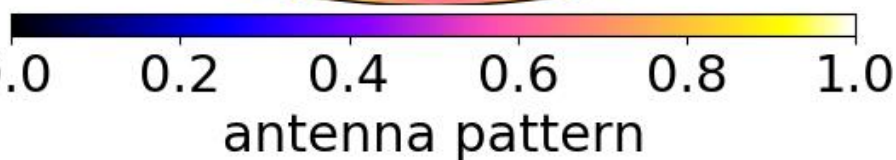
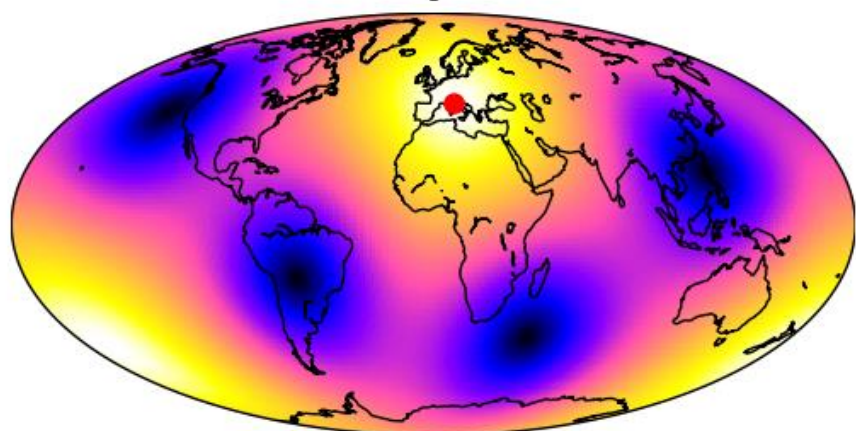

K

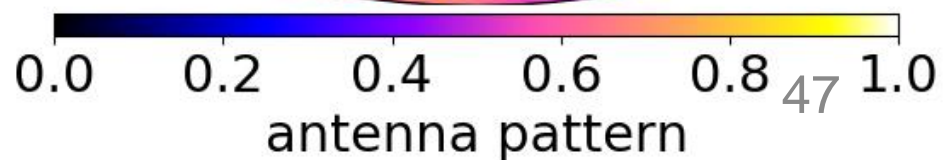
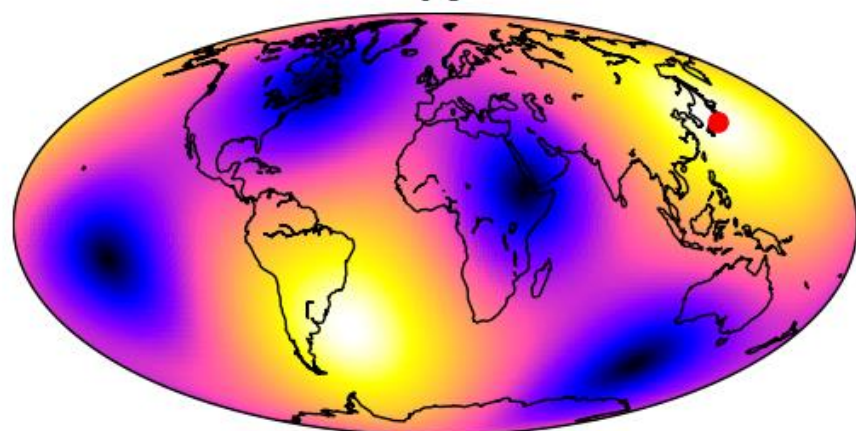



# 2G/2G+ Parameter Comparison

	<b>KAGRA</b>	<b>AdVirgo</b>	<b>aLIGO</b>	<b>A+</b>	<b>Voyager</b>
Arm length [km]	3	3	4	4	4
Mirror mass [kg]	23	42	40	80	200
Mirror material	Sapphire	Silica	Silica	Silica	Silicon
Mirror temp [K]	22	295	295	295	123
Sus fiber	35cm Sap.	70cm SiO <sub>2</sub>	60cm SiO <sub>2</sub>	60cm SiO <sub>2</sub>	60cm Si
Fiber type	Fiber	Fiber	Fiber	Fiber	Ribbon
Input power [W]	67	125	125	125	140
Arm power [kW]	340	700	710	1150	3000
Wavelength [nm]	1064	1064	1064	1064	2000
Beam size [cm]	3.5 / 3.5	4.9 / 5.8	5.5 / 6.2	5.5 / 6.2	5.8 / 6.2
SQZ factor	0	0	0	6	8
F. C. length [m]	none	none	none	16	300



# KAGRA Detailed Parameters

K. Komori *et al.*, [JGW-T1707038](#)

- **Optical parameters**
  - Mirror transmission: 0.4 % for ITM, 10 % for PRM, 15.36 % for SRM
  - Power at BS: 674 W
  - Detune phase: 3.5 deg (DRSE case)
  - Homodyne phase: 135.1 deg (DRSE case)
- **Sapphire mirror parameters**
  - TM size: 220 mm dia., 150 mm thick
  - TM mass: 22.8 kg
  - TM temperature: 22 K
  - Beam radius at ITM: 3.5 cm
  - Beam radius at ETM: 3.5 cm
  - Q of mirror substrate:  $1e8$
  - Coating: tantala/silica
  - Coating loss angle:  $3e-4$  for silica,  $5e-4$  for tantala
  - Number of layers: 22 for ITM, 40 for ETM
  - Coating absorption: 0.5 ppm
  - Substrate absorption: 50 ppm/cm
- **Suspension parameters**
  - TM-IM fiber: 35 cm long, 1.6 mm dia.
  - IM temperature: 16 K
  - Heat extraction: 5800 W/m/K at 20 K
  - Loss angle:  $5e-6/2e-7/7e-7$  for CuBe fiber/sapphire fiber/sapphire blade
- **Inspirial range calculation**
  - SNR=8,  $f_{min}=10$  Hz, sky average constant 0.442478
- Seismic noise curve includes vertical coupling, vibration from heatlinks and Newtonian noise from surface and bulk

# KAGRA Cryopayload

Provided by T. Ushiba and T. Miyamoto

Platform  
(SUS, 65 kg)

Marionette  
(SUS, 22.5 kg)

Intermediate Mass  
(SUS, 20.1 kg,  
16 K)

Test Mass  
(Sapphire, 23 kg,  
22 K)

3 CuBe blade springs

MN suspended by 1 Maraging steel fiber  
(35 cm long, 2-7mm dia.)  
MRM suspended by 3 CuBe fibers

Heat link attached to MN

IM suspended by 4 CuBe fibers  
(24 cm long, 0.6 mm dia)  
IRM suspended by 4 CuBe fibers

4 sapphire blades

TM suspended by 4 sapphire fibers  
(35 cm long, 1.6 mm dia.)  
RM suspended by 4 CuBe fibers

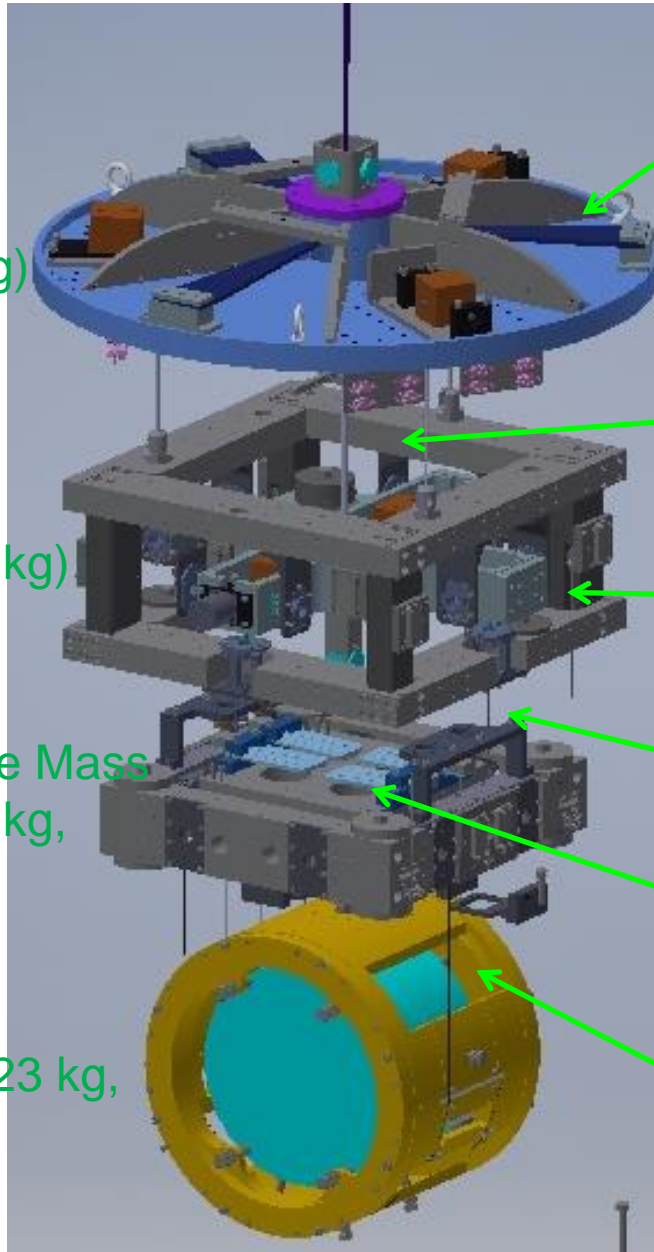

# KAGRA Cryostat Schematic

