

List of RF Cables to Purchase for  
bKAGRA  
**JANUARY 2019 UPDATE**

Yuta Michimura

Department of Physics, University of Tokyo

# References

- List of PDs and QPDs  
<https://docs.google.com/spreadsheets/d/1EcuZOQP8yrD3s7no9PPGSxSD0V3NGAFvx799leWH-1U/edit#gid=2019224000>
- List of electronics for ISC  
<http://gwwiki.icrr.u-tokyo.ac.jp/JGWwiki/KAGRA/Subgroups/MIF/AEL>
- ISC Electrical Components Layout  
<https://gwdoc.icrr.u-tokyo.ac.jp/cgi-bin/private/DocDB/ShowDocument?docid=2986>
- RF Cabling Policy  
<https://gwdoc.icrr.u-tokyo.ac.jp/cgi-bin/private/DocDB/ShowDocument?docid=3190>
- Cable lengths for iKAGRA ISC  
<https://gwdoc.icrr.u-tokyo.ac.jp/cgi-bin/private/DocDB/ShowDocument?docid=3028>
- **ISC system circuit diagram**  
<https://gwdoc.icrr.u-tokyo.ac.jp/cgi-bin/private/DocDB/ShowDocument?docid=8394>

# KAGRA Layout (Not Complete)

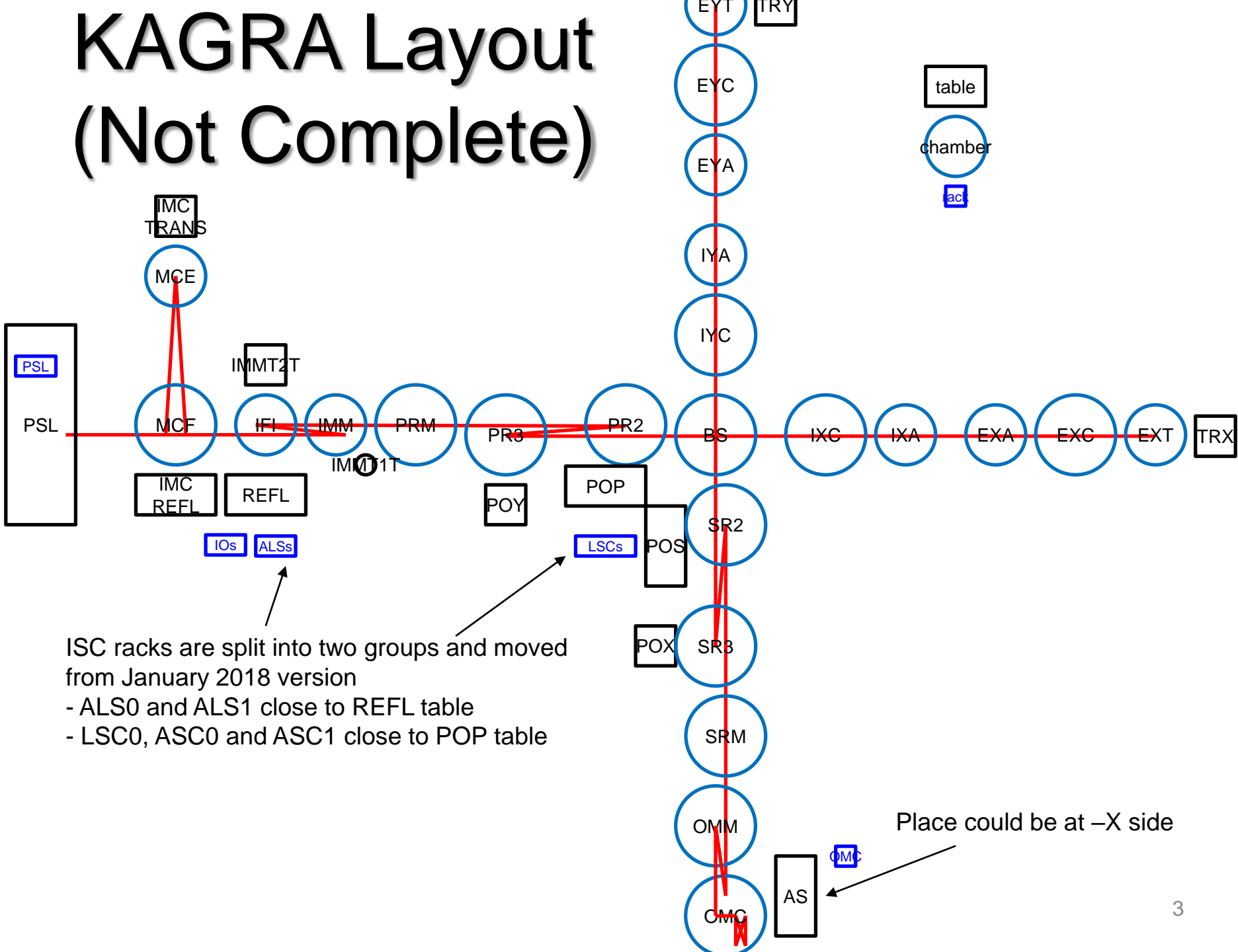

ISC racks are split into two groups and moved from January 2018 version

- ALS0 and ALS1 close to REFL table
- LSC0, ASC0 and ASC1 close to POP table

Place could be at -X side

# KAGRA Layout (ISC Components)

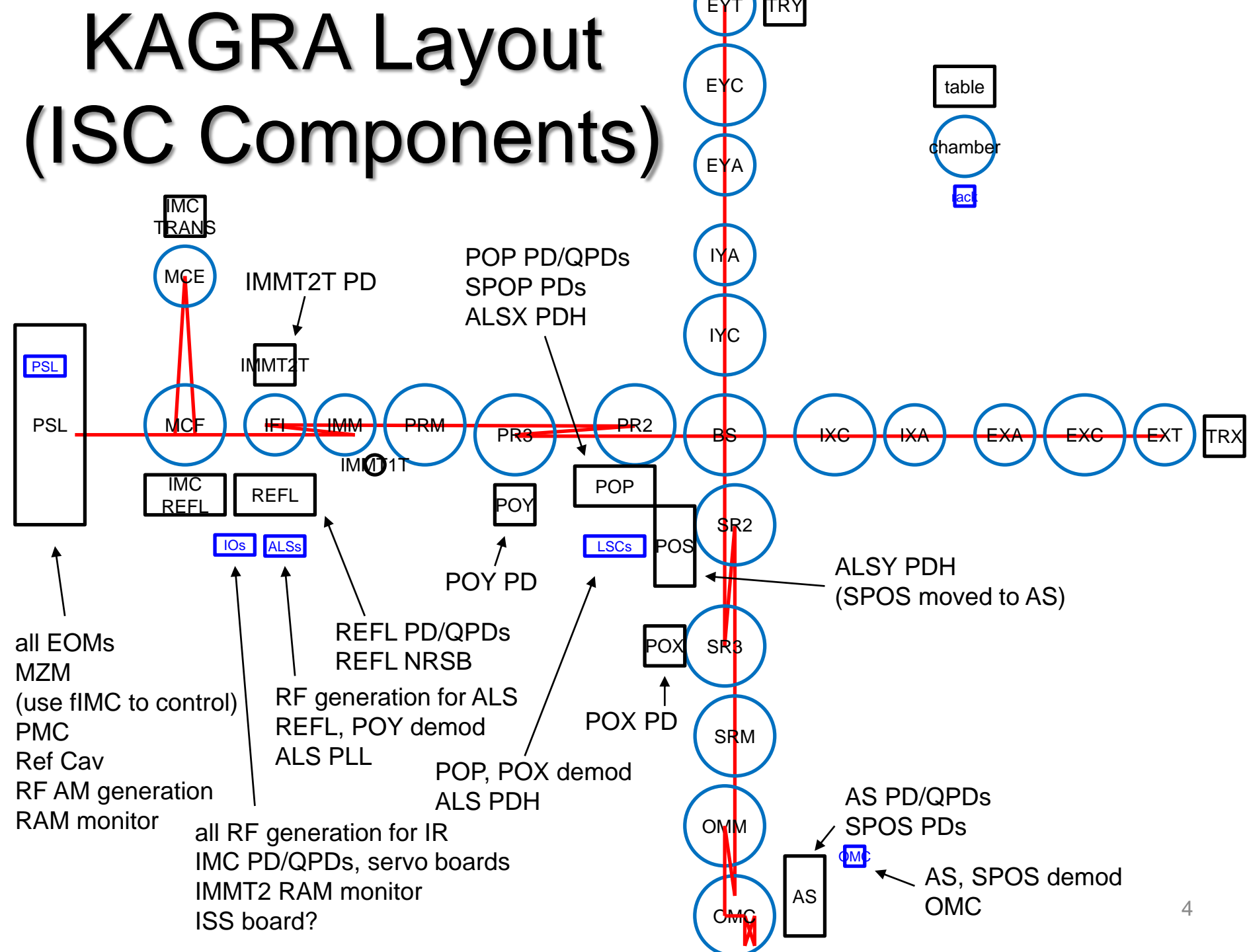

# KAGRA Layout (RF Cables)

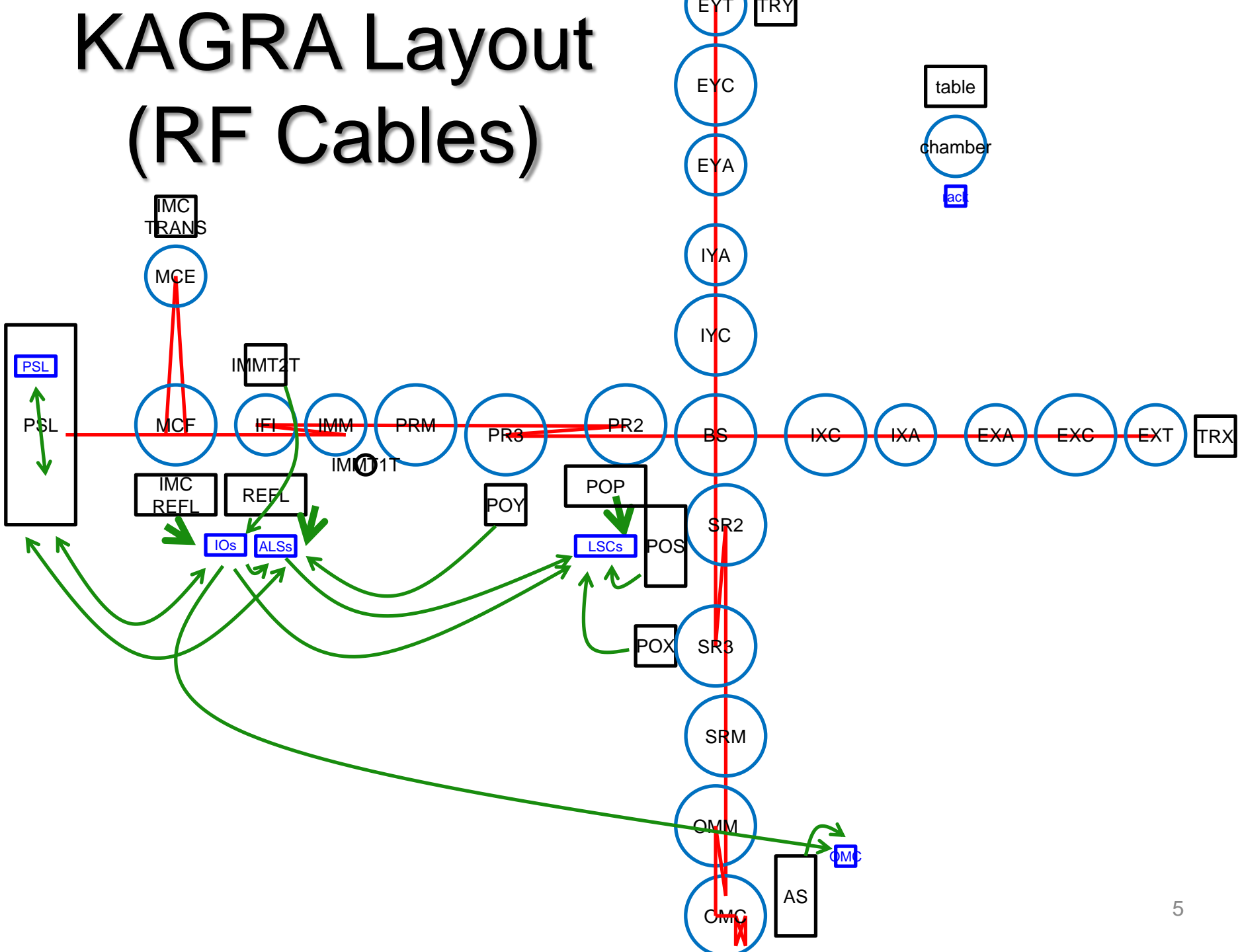

# Number of RF Cables

- PSL table ↔ PSL rack **2 cables** 15MHz EOM, 51.72MHz EOM
- PSL table ↔ IOO rack **9 cables** f2/fIMC EOM, f1/f3 EOM x2, AM delay line RFPD, RAM MON(fIMC/spare), RefCav VCO
- PSL table ↔ ALS rack **6 cables** ALSX EOM, ALSY EOM, ALSX BEAT, ALSY BEAT, ALSX VCO, ALSY VCO
- IMC REFL table ↔ IOO rack **9 cables** IMCR(fIMC), IMCR QPDx2(fIMC)
- IMMT2 table ↔ IOO rack **2 cables** RAM MON(f1/f2)
- IOO rack ↔ ALS rack **4 cables** f1, f2, f3-f1, f3-f2 ↓ updated on Jan 30, 2019
- REFL table ↔ ALS rack **20 cables + 20 cables** REFL(f1/f2), REFLNRSB(f3-f1/f3-f2), REFL QPDx2(f1/f2), REFLVAC\_A(f1/f2), REFLVAC\_B(f1/f2?), REFLVACQPDx2(f1/f2)
- POY table ↔ ALS rack **2 cables + 2 cables** POY(f1/f2), POYVAC(f1/f2)
- IOO rack ↔ LSC rack **4 cables** f1, f2, 2\*f1, 2\*f2
- ALS rack ↔ LSC rack **2 cables** fALSX, fALSY ↓ updated on Jan 31, 2019
- POP table ↔ LSC rack **21 cables + 18 cables** POP(f1/f2), SPOP(2\*f1/2\*f2), POP QPDx2(f1/f2), ALSX PDH, POPVAC(f1/f2), POPVAC QPDx2(f1/f2)
- POS table ↔ LSC rack **1 cables** ALSY PDH
- POX table ↔ LSC rack **2 cables + 2 cables** POX(f1/f2), POXVAC(f1/f2)
- IOO rack ↔ OMC rack **2 cables** f1, 2\*f1
- AS table ↔ OMC rack **10 cables** AS(f1), AS QPDx2(f1), SPOS(2\*f1)
- Misc. intra-rack, intra-table **~100 cables ?**

# Length of RF Cables

- PSL table ↔ PSL rack **5 m**
- PSL table ↔ IOO rack **30 m**
- PSL table ↔ ALS rack **30 m** (should be similar to PSL table ↔ IOO rack)
- IMC REFL table ↔ IOO rack **10 m** (measured to be ~7 m)
- IMMT2 table ↔ IOO rack **10 m** (measured to be ~8 m)
- IOO rack ↔ ALS rack **5 m** (should be close)
- REFL table ↔ ALS rack **15 m** (measured to be ~11 m)
- POY table ↔ ALS rack **20 m** (measured to be ~17 m for POY table ↔ IOO rack)
- IOO rack ↔ LSC rack **30 m** (actually did it with 30 m cable)
- ALS rack ↔ LSC rack **30 m** (should be similar to IOO rack ↔ LSC rack)
- POP table ↔ LSC rack **10 m** (measured to be ~11 m) ←updated from 15m to 10m on Jan 30,2019
- POS table ↔ LSC rack **15 m** (measured to be ~12 m)
- POX table ↔ LSC rack **30 m** (measured to be ~27 m)
- IOO rack ↔ OMC rack **70 m** (measured to be ~62 m; from IOO rack, go under SR2-SR3 pipe and lay the cable on the cable rack at +X side)
- AS table ↔ OMC rack **20 m** (measured to be ~16 m)
- Misc. intra-rack, intra-table **1 m, 2 m**
- SMA patch panel to IQ demodulator **0.3 m** (for RF QPDs for REFL(f1/f2),POP(f1/f2), AS(f1))

↓ updated on Jan 30, 2019

# Number of SMA Cables Summary

Note that there are also N-N cables with 0.5, 3, 5, 7 m length

<https://docs.google.com/spreadsheets/d/1VPkv64gDrbhSX4LiO5aNc-miSf3h3p1dRQPKUhnucs/>

Length	from iKAGRA days	January 2018 purchase	Nov. 2018 purchase	Total we have	Total Necessary <small>* cables for in-vac in ( )</small>	TO BUY
0.3 m				0	40 (+40)	50
1 m	20			20	Many	
2 m	20			20	Many	
5 m	20	10		30	6	
10 m	20	40		60	32 (+18)	
15 m			20	20	21 (+20)	30
20 m		10	10	20	12 (+2)	
30 m		30		30	23 (+2)	
40 m		10		10	0	
50 m		10		10	0	
70 m			4	4	2	8