

# Possibility of Upgrading KAGRA

Yuta Michimura

Department of Physics, University of Tokyo

with much help from

Kentaro Komori, Yutaro Enomoto, Koji Nagano,  
Kentaro Somiya, Sadakazu Haino .....

# KAGRA Timeline

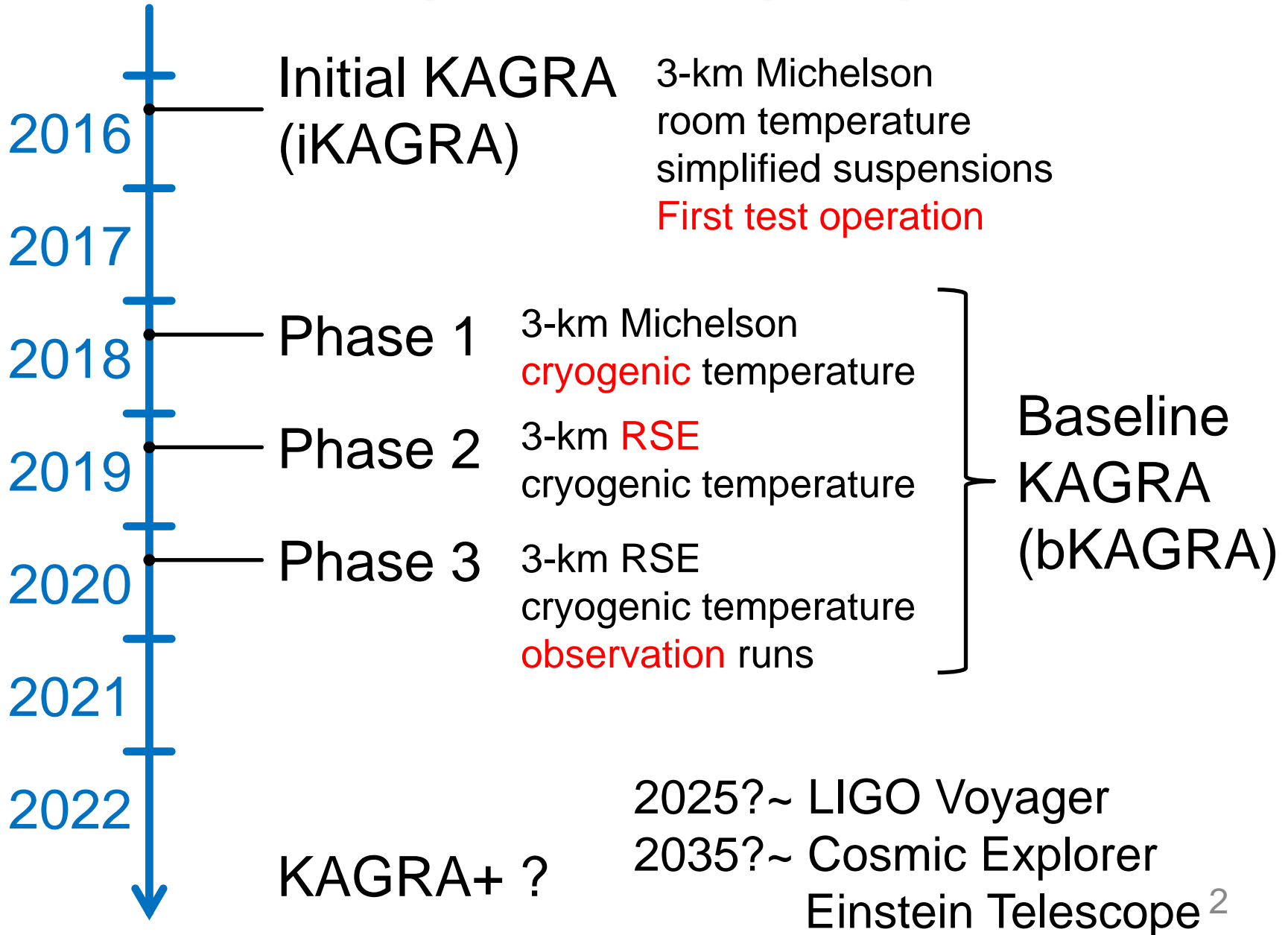

# KAGRA Configuration

- Cryogenic
- Underground
- Resonant Sideband Extraction (RSE) interferometer

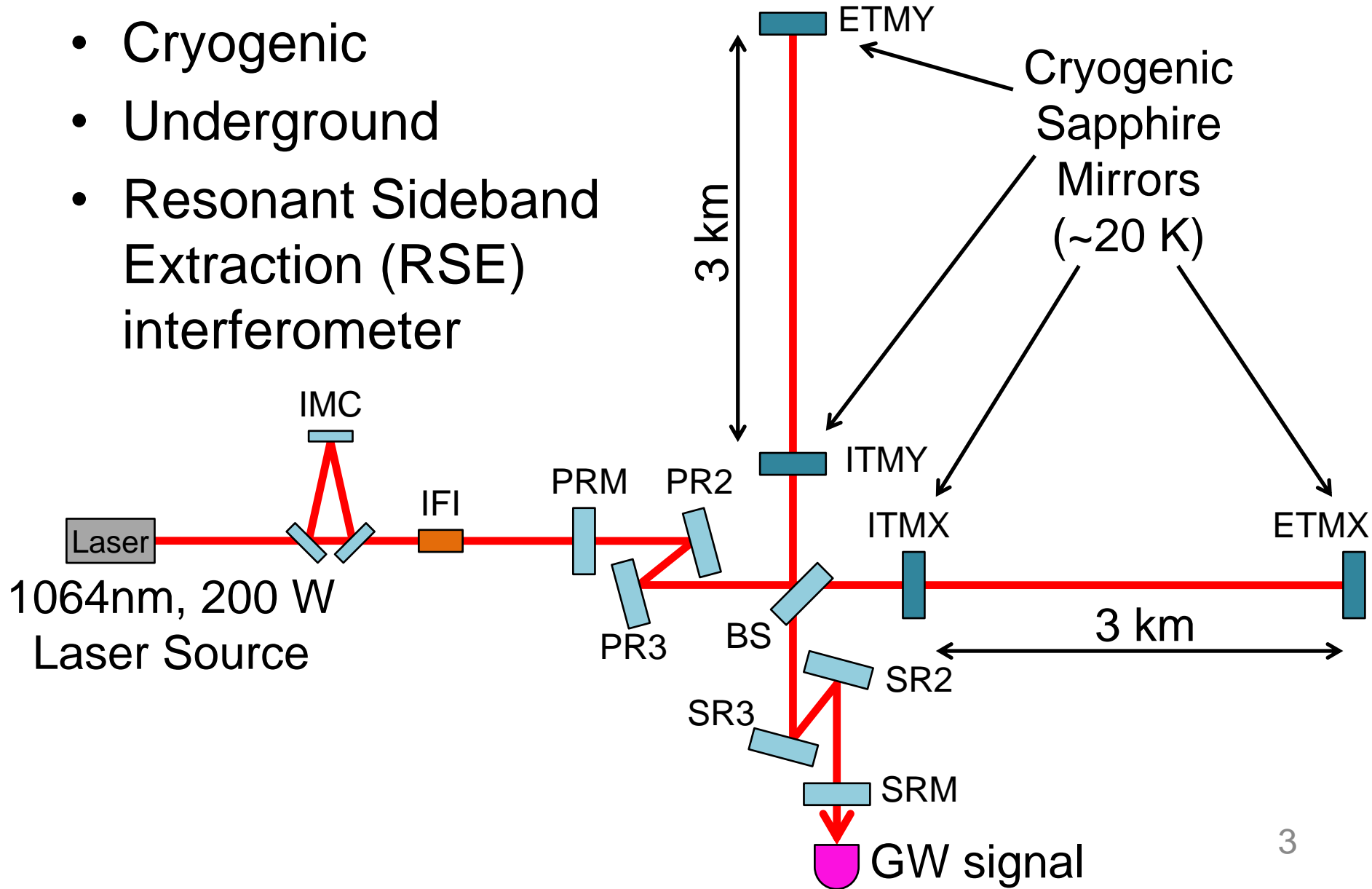

# KAGRA Sensitivity (v2017)

- BNS range 158 Mpc, BBH(30Msun) range 1.0 Gpc

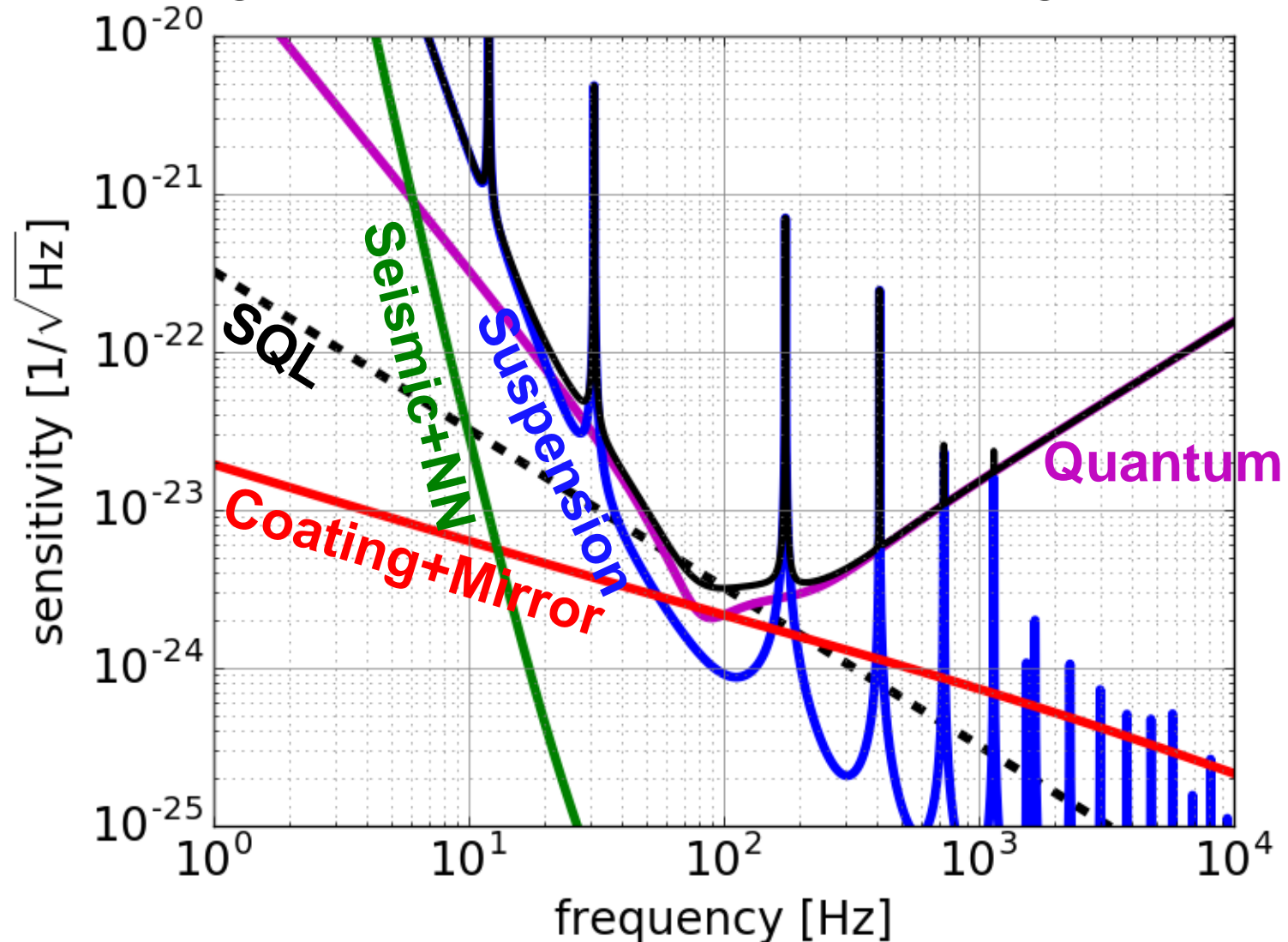

# KAGRA vs Other 2G

- **Not better** even with cryogenic and underground

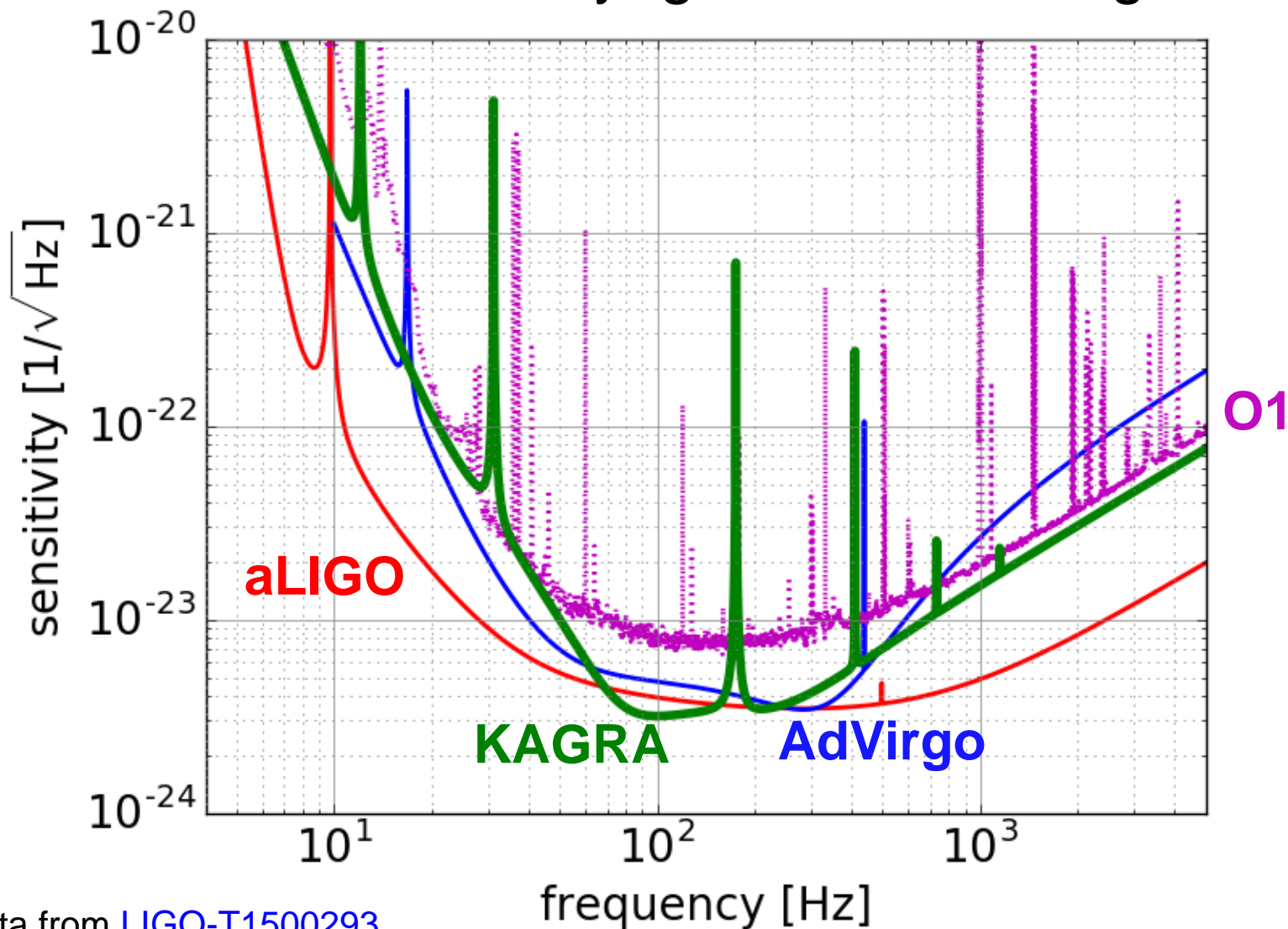

# Seismic Noise

- Basically low, thanks to underground and tower suspensions 😊

Plot by A. Shoda ([JGW-G1706740](#))

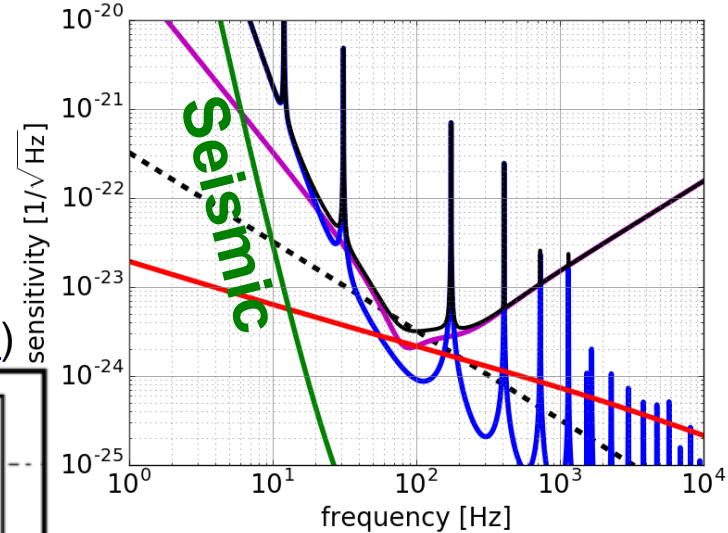
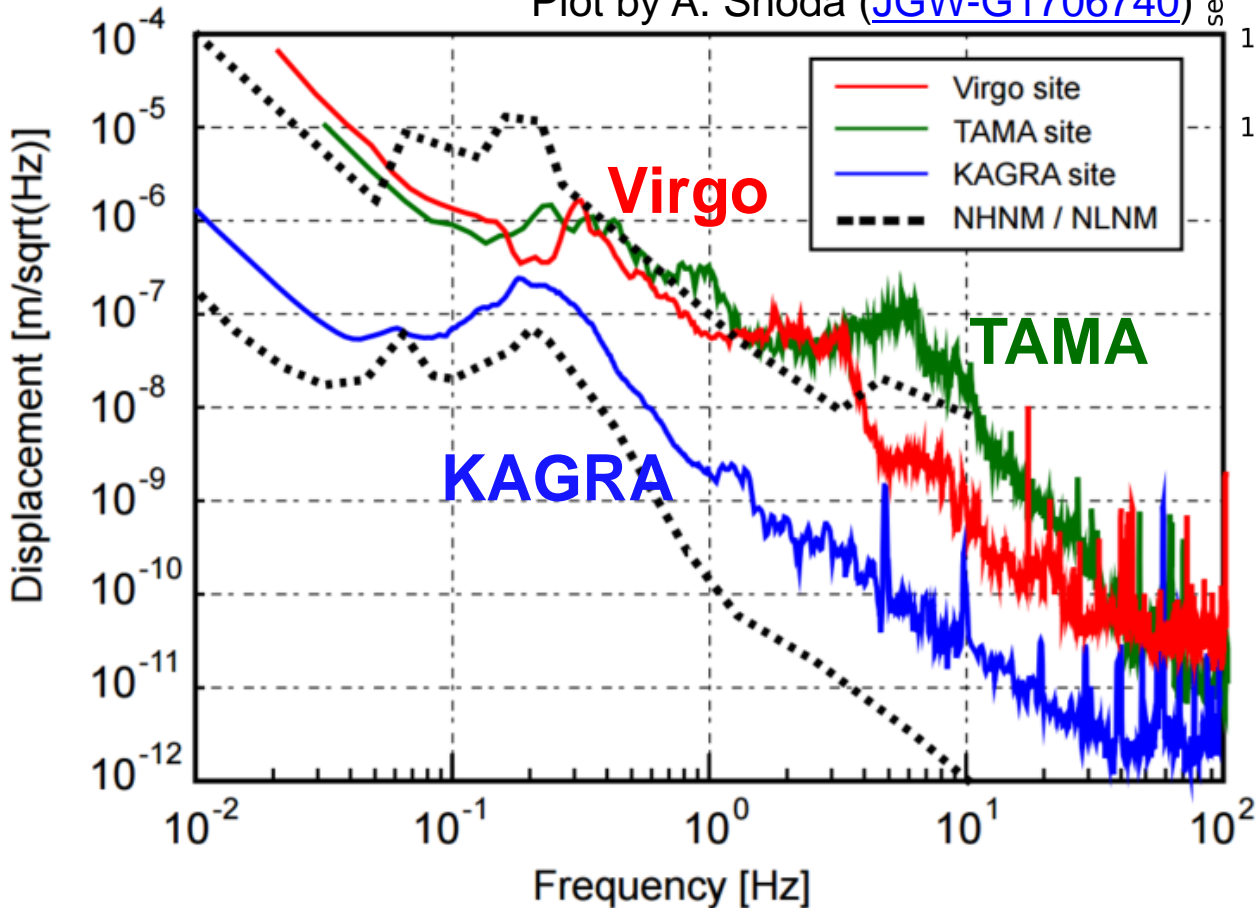

# Thermal Noise

- Cryogenic temperature  
high Q (low loss) sapphire  
reduces thermal noise 😊
- **Thick sapphire fibers** to  
extract heat increase  
suspension thermal noise 😞
- **Smaller beam sizes** because  
of smaller mirrors increase  
coating thermal noise 😞

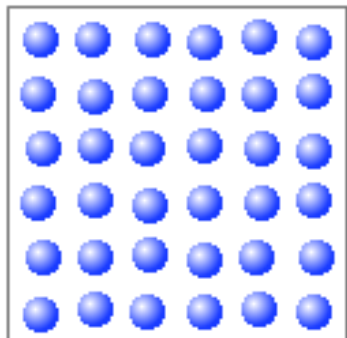
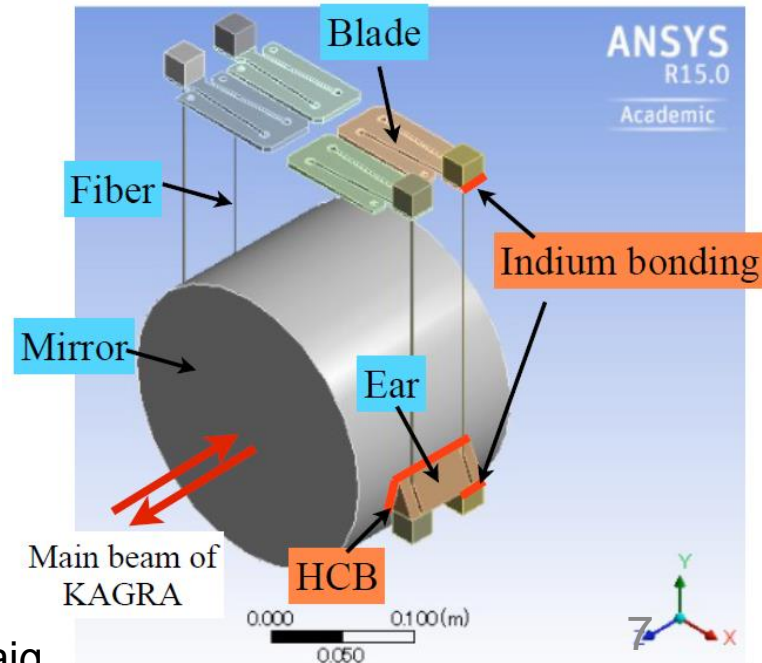
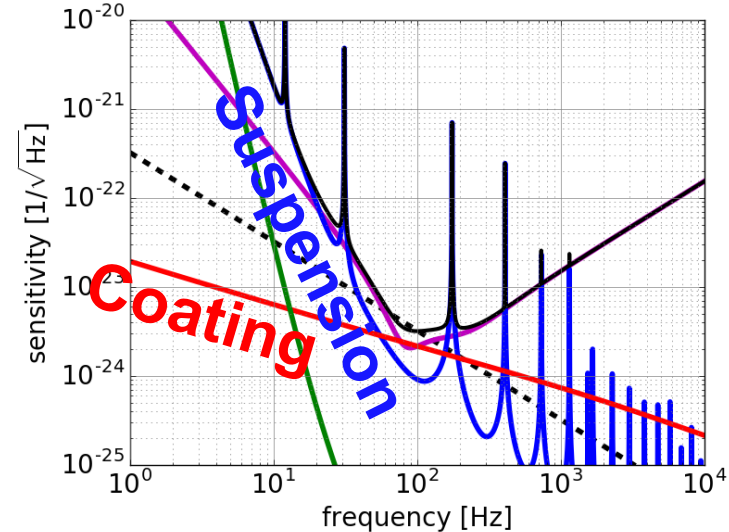
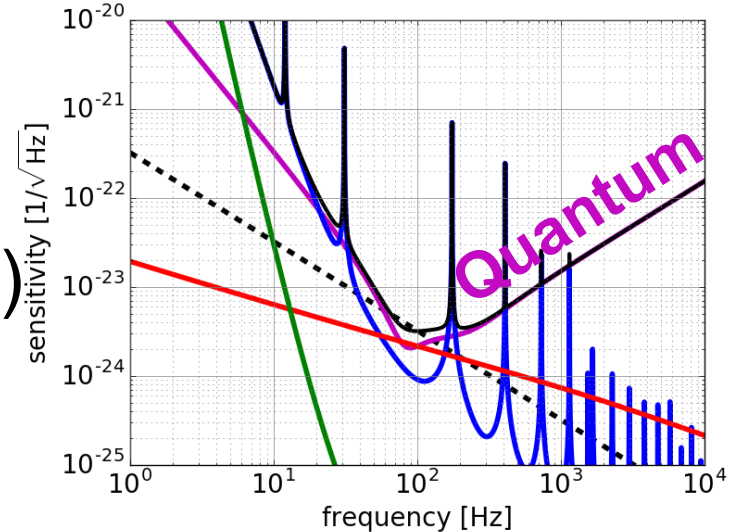

Figure from K. Craig



# Quantum Noise

- 23 kg mirror was the largest sapphire mirror we can get (aLIGO: 40 kg, AdVirgo: 42 kg)
- **Smaller mirror** increases radiation pressure noise ☹️
- **Less laser power** because of limited heat extraction increases shot noise ☹️  
Intra-cavity power  
KAGRA: 400 kW, aLIGO/AdVirgo: 700 kW





# Ideas for Improving Sensitivity

- **Increase the mass**
  - GAST project (upto 30 cm dia. ?)
  - composite mass
  - A-axis sapphire (upto 50 kg, 26 cm dia.)
  - non-cylindrical mass (upto 30 kg)
  - go silicon (upto 200 kg, 45 cm dia.)
- **Frequency dependent squeezing** (Filter cavity)
  - effectively increase mass and laser power
- **Better coating, low absorption mirror**
- **Better cryogenic suspension design**
- ETM different from ITM, half-cryogenic, delay-line, folded arms, higher-order modes, suspension point interferometer ..... ???

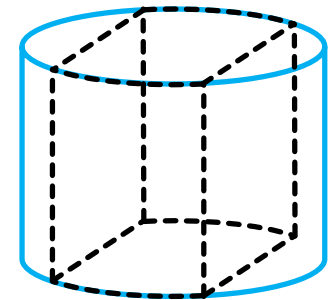
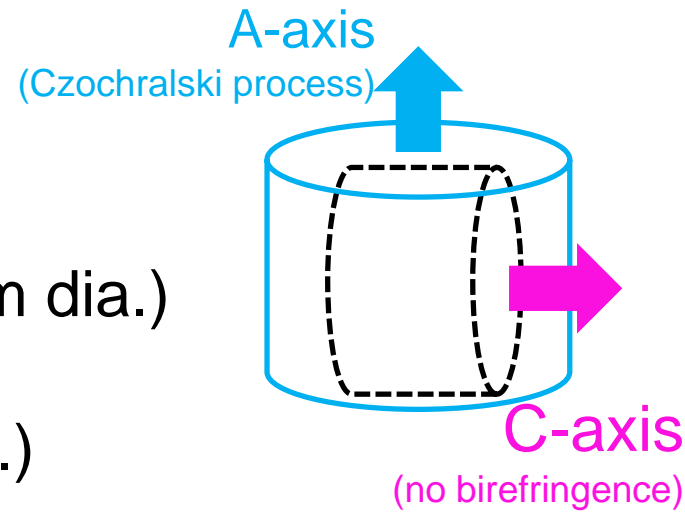

# Effect in Sensitivity

Heavier mass BHs, etc.

EOS of NS, SN, etc.

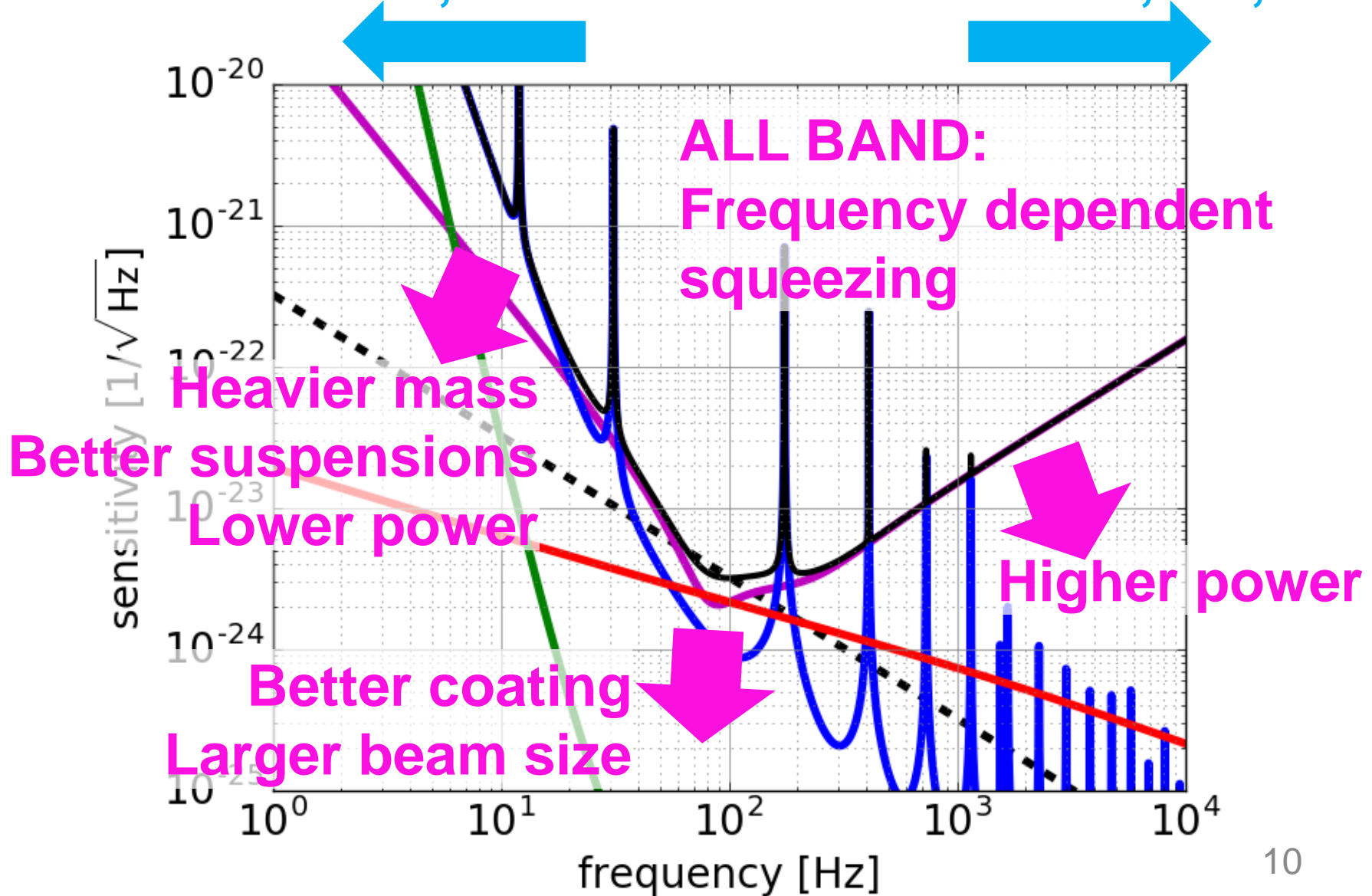

# Technical Difficulty

Heavier mass BHs, etc.

EOS of NS, SN, etc.

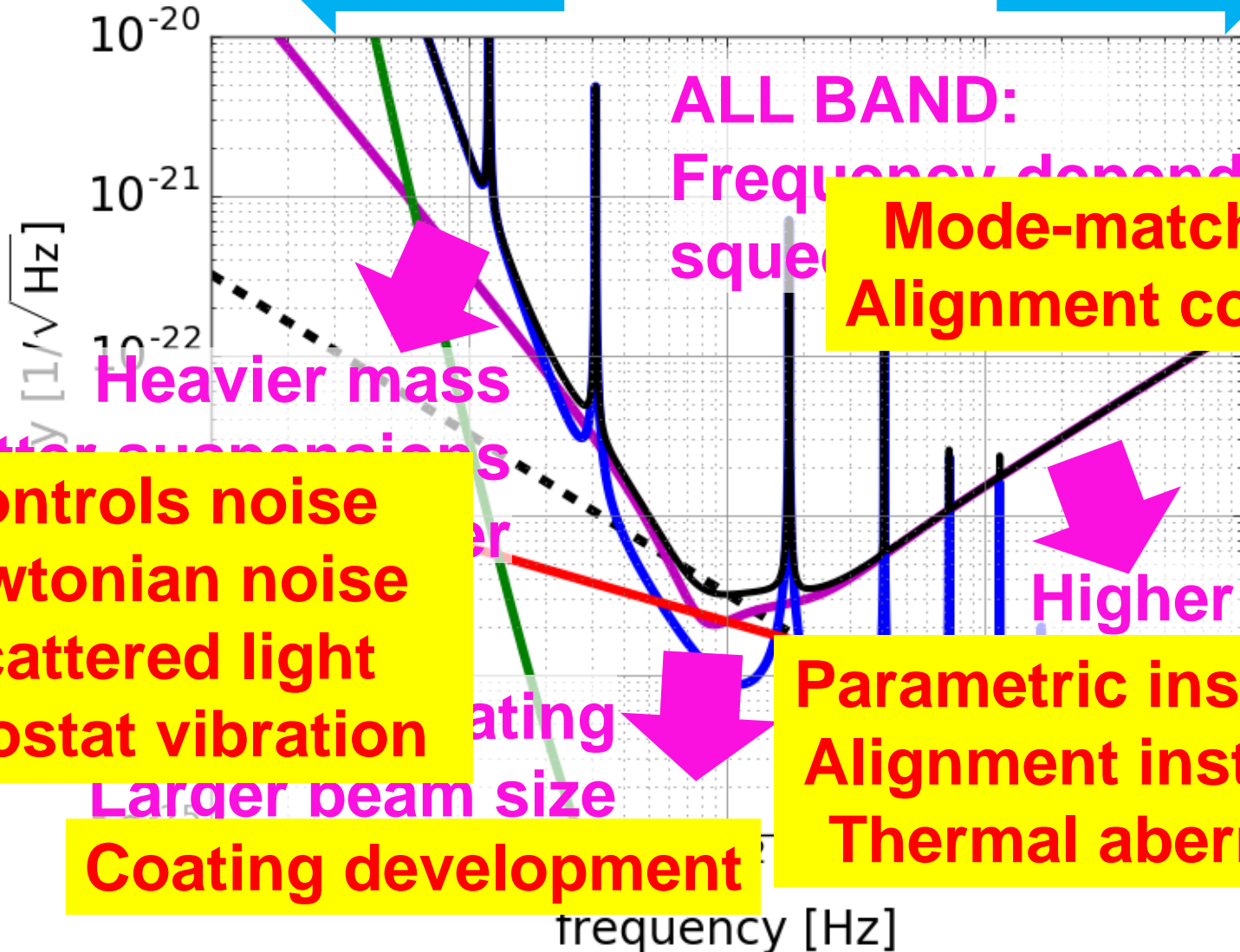

Controls noise  
 Newtonian noise  
 Scattered light  
 Cryostat vibration

Larger beam size  
 Coating development

Mode-matching  
 Alignment control

Parametric instability  
 Alignment instability  
 Thermal aberration

# Integrated Design Study

- We need a plan to **integrate** these ideas
- To begin with, some **example plans** were proposed
- Plan: **Blue** (by Yutaro Enomoto)  
use heavier sapphire mirrors
- Plan: **Black** (by Kentaro Komori)  
use silicon mirrors
- Plan: **Brown** (by Koji Nagano)  
lower the power to focus on low frequency
- Plan: **Red** (by Sadakazu Haino)  
increase the power to focus on high frequency



# KAGRA+ Sensitivity: Blue

- Heavier sapphire and heavier IM, 20 K

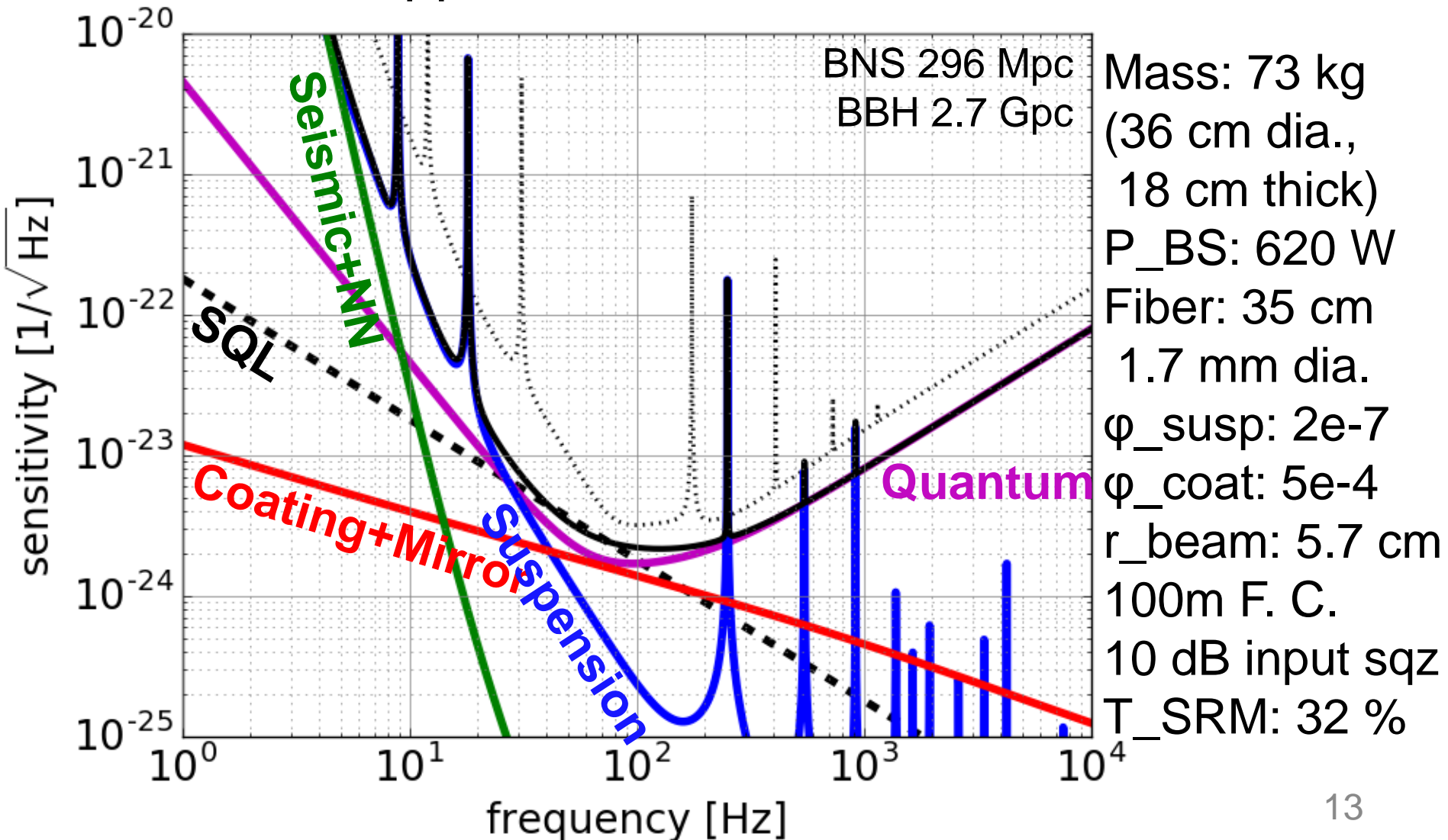

# KAGRA+ Sensitivity: Black

- Silicon 123 K, 1550 nm, radiative cooling

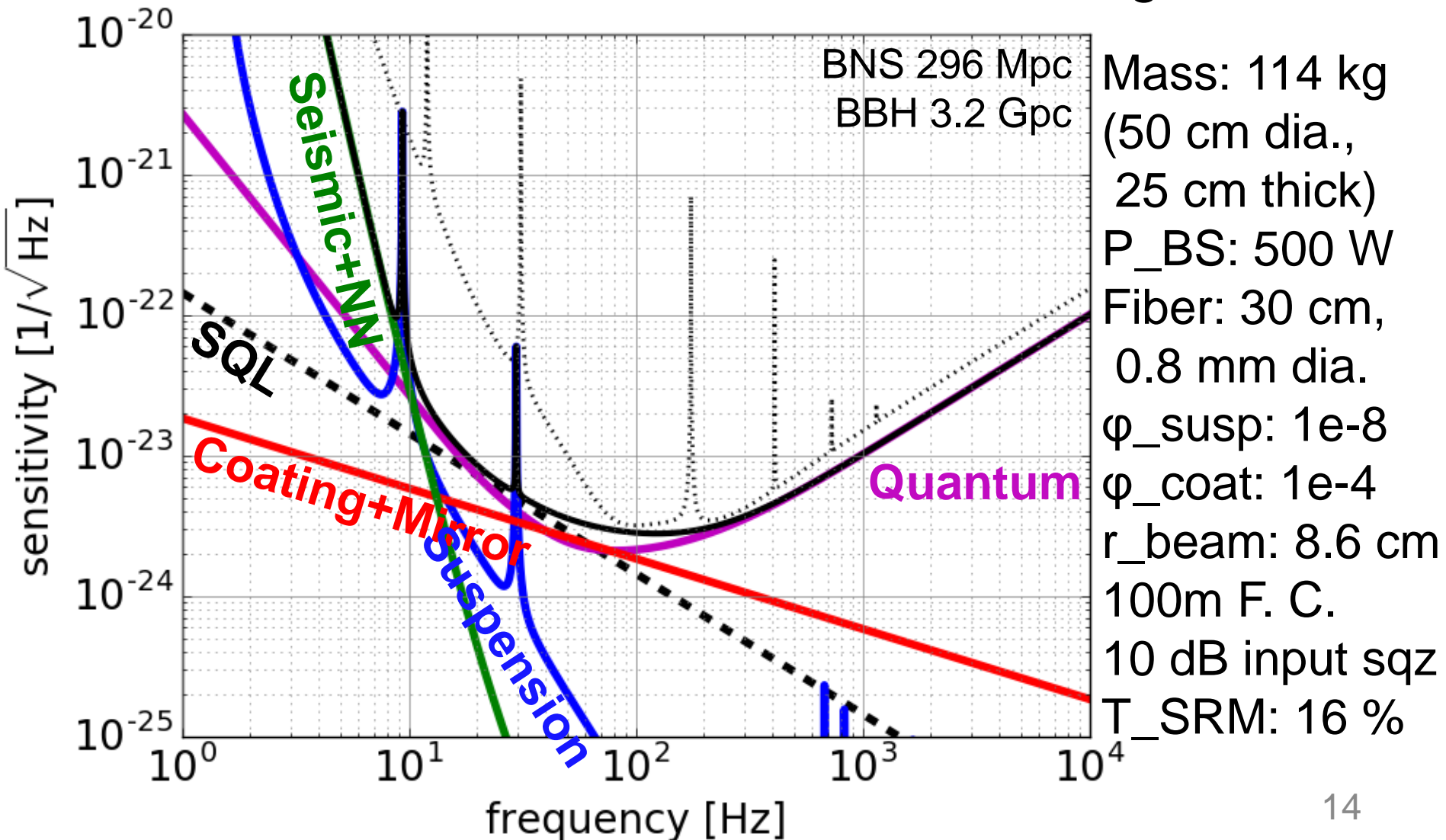



# KAGRA+ Sensitivity: **Brown**

- Same test mass, low power, high detuning, 20 K

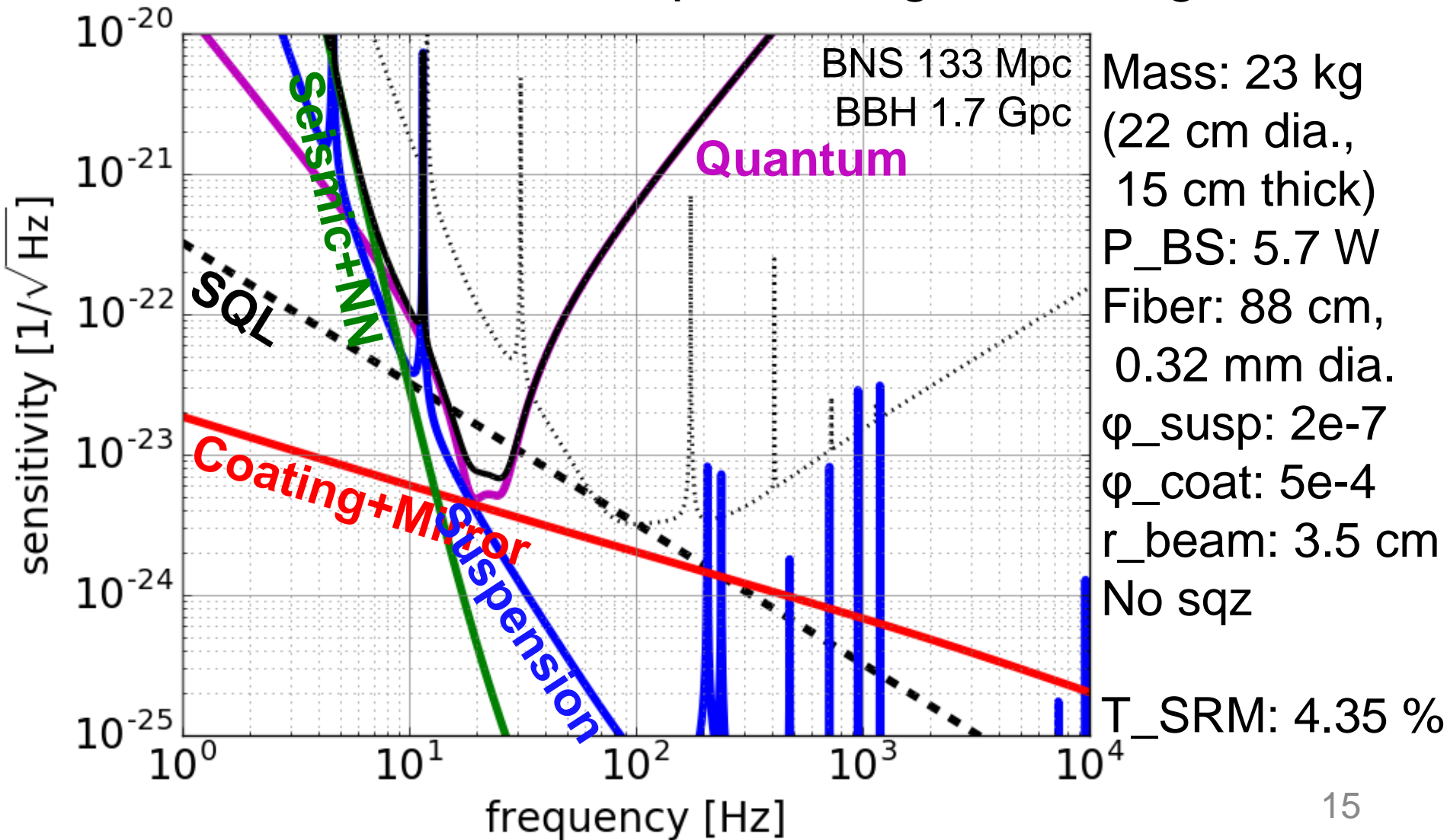



# KAGRA+ Sensitivity: **Red**

- Same test mass, high power, 24 K

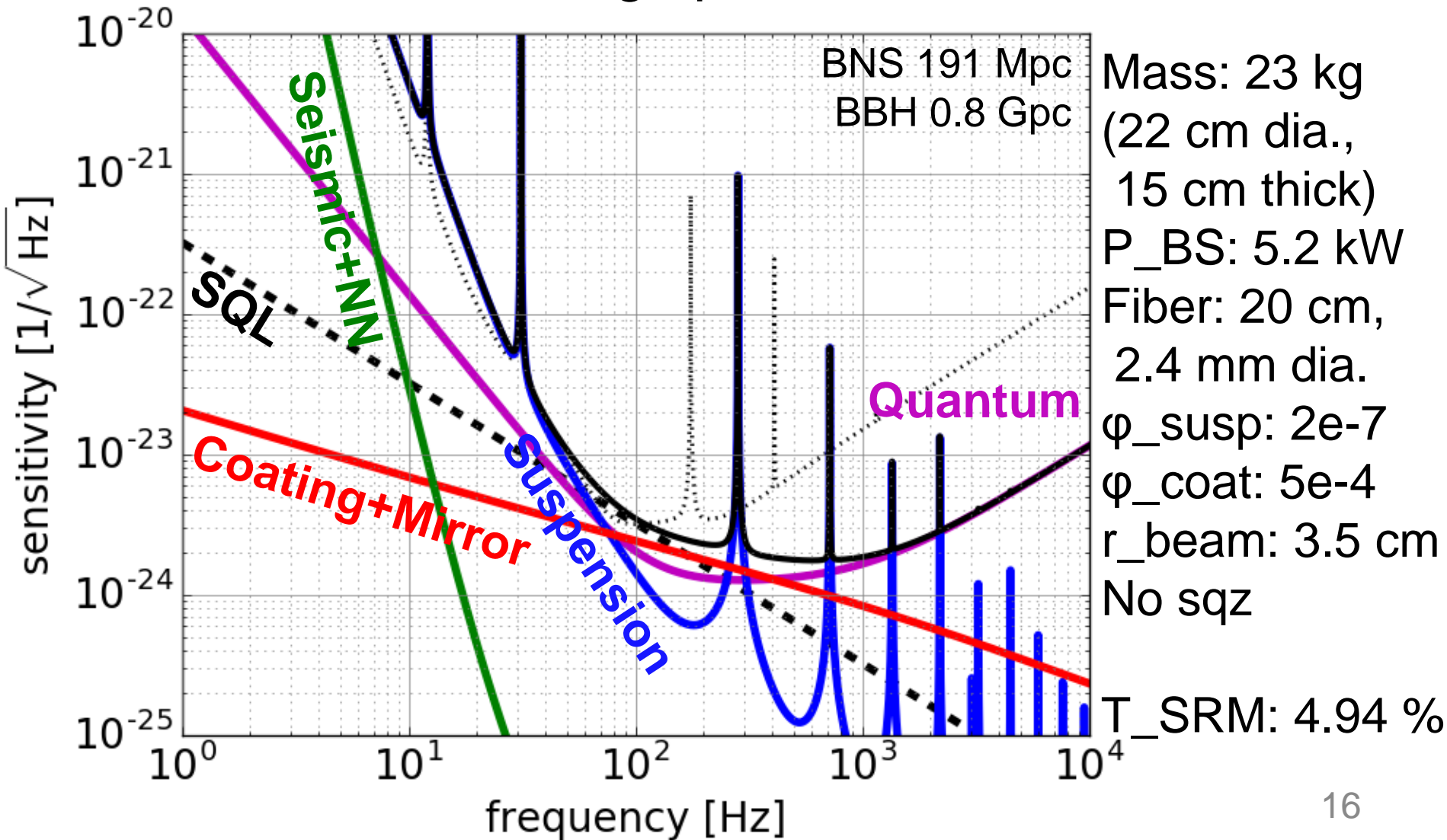

# Sensitivity Comparison

- Also feasibility study necessary

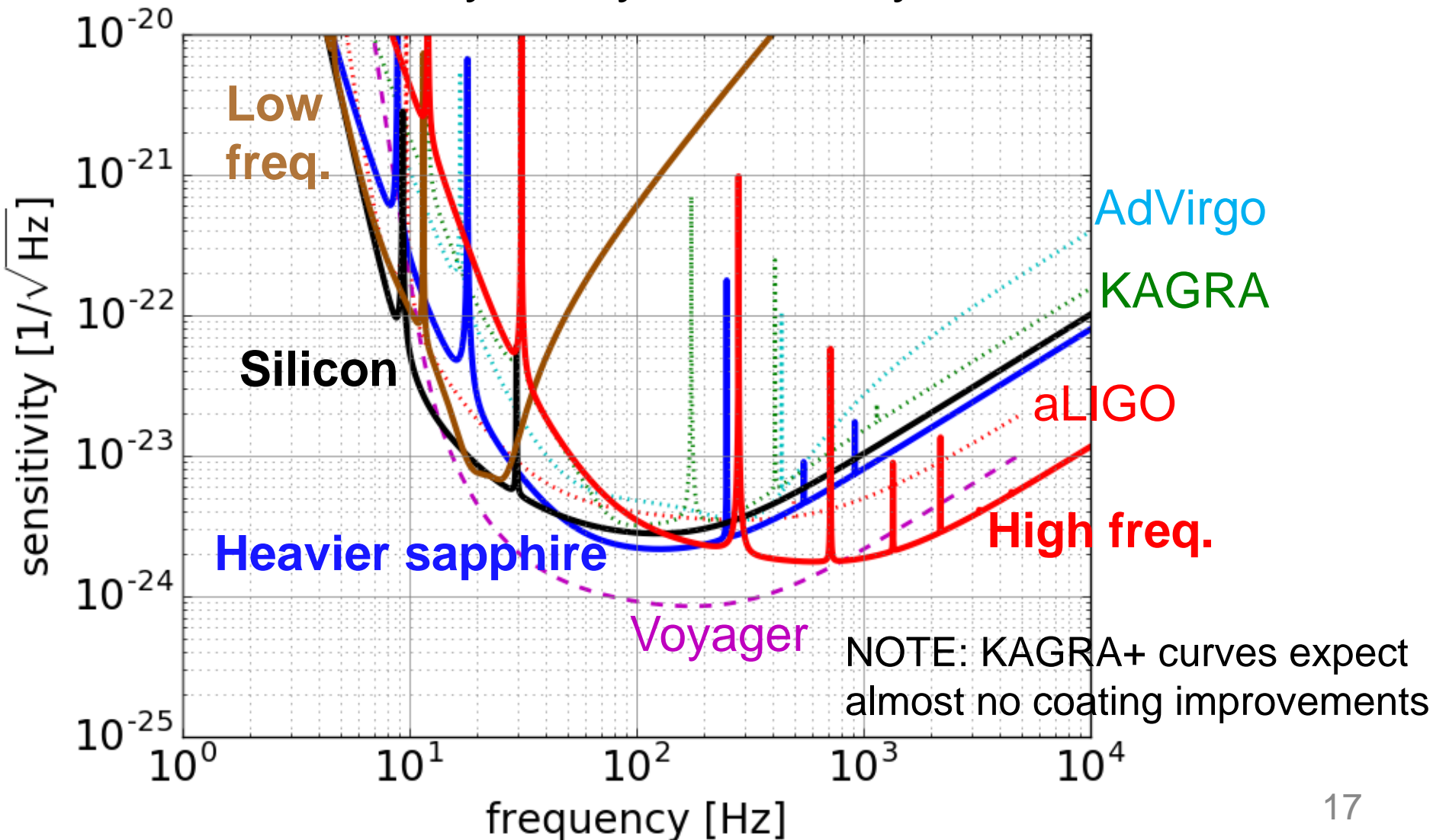

# Astrophysical Reach Comparison

- Science case discussion is necessary

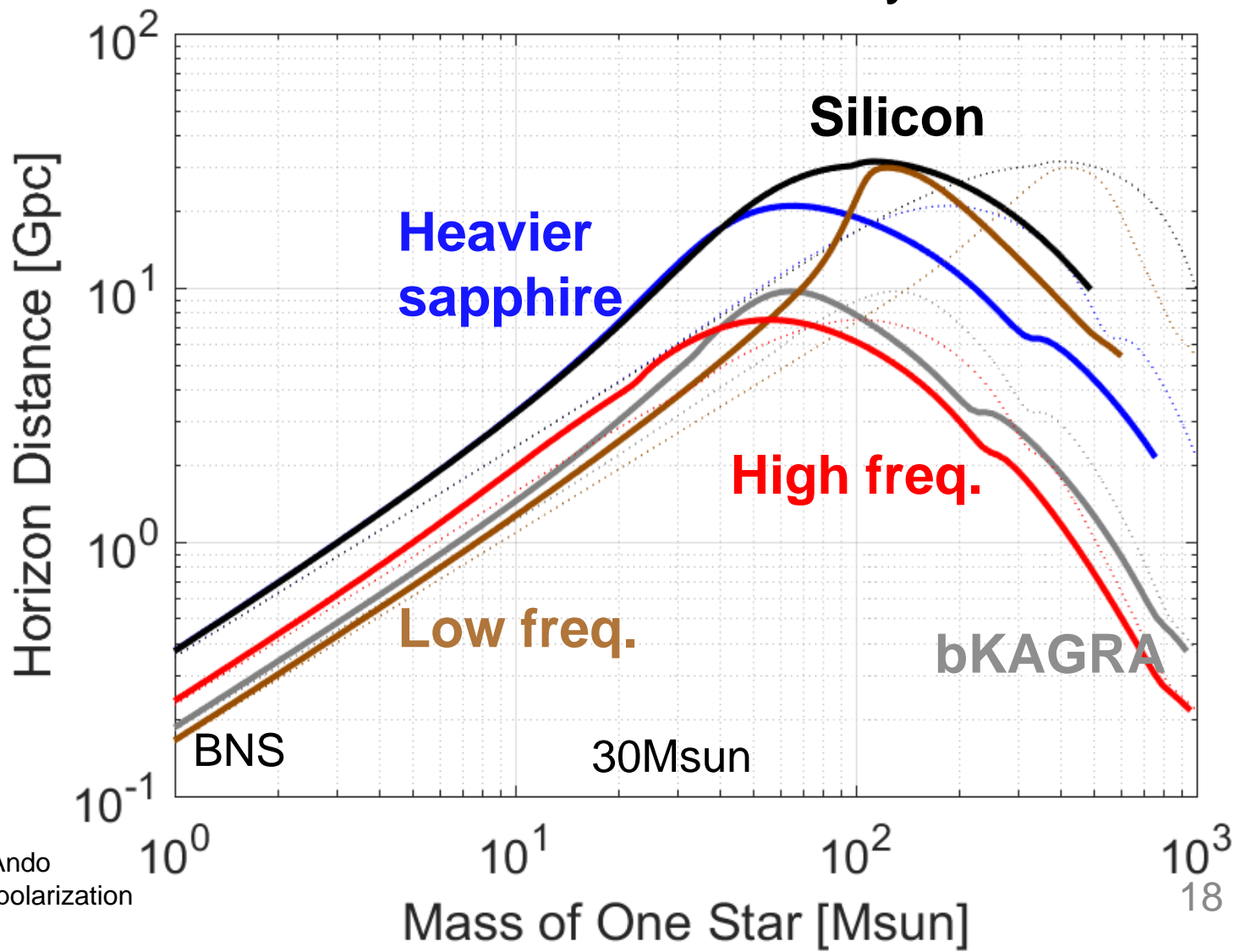

# Discussions

- What is the best **figure of merit** to compare the plans?
  - Sensitivity curve (with error bars)?
  - Inspiral range? What mass?
  - Event rate (with error bars)?
  - Parameter estimation accuracy?
- **Broadband or narrowband** in high event rate regime by aLIGO + AdVirgo?
  - Does 4th detector help parameter estimation?
- What about real **3G** detector (~10 km class)?
  - Asia-Australian 8-km detector?
  - Where?

# Summary

- Many ideas for improving the sensitivity have been proposed, and some R&D are on going
- Sensitivity design study on future KAGRA upgrade to **integrate** these ideas is necessary
- There are some example plans
- Need **more serious discussion** based on science, feasibility, budget and timeline
- Any comments? New ideas?

# Supplementary Slides

# 2G/2G+ Parameter Comparison

	<b>KAGRA</b>	<b>AdVirgo</b>	<b>aLIGO</b>	<b>A+</b>	<b>Voyager</b>
Arm length [km]	3	3	4	4	4
Mirror mass [kg]	23	42	40	80	200
Mirror material	Sapphire	Silica	Silica	Silica	Silicon
Mirror temp [K]	21	295	295	295	123
Sus fiber	35cm Sap.	70cm SiO <sub>2</sub>	60cm SiO <sub>2</sub>	60cm SiO <sub>2</sub>	60cm Si
Fiber type	Fiber	Fiber	Fiber	Fiber	Ribbon
Input power [W]	78	125	125	125	140
Arm power [kW]	400	700	710	1150	3000
Wavelength [nm]	1064	1064	1064	1064	2000
Beam size [cm]	3.5 / 3.5	4.9 / 5.8	5.5 / 6.2	5.5 / 6.2	5.8 / 6.2
SQZ factor	0	0	0	6	8
F. C. length [m]	none	none	none	16	300



# KAGRA Detailed Parameters

- **Optical parameters**
  - Mirror transmission: 0.4 % for ITM, 10 % for PRM, 15.36 % for SRM
  - Power at BS: 780 W
  - Detune phase: 3.5 deg (DRSE case)
  - Homodyne phase: 133 deg (DRSE case)
- **Sapphire mirror parameters**
  - TM size: 220 mm dia., 150 mm thick
  - TM mass: 22.8 kg
  - TM temperature: 21.5 K
  - Beam radius at ITM: 3.5 cm
  - Beam radius at ETM: 3.5 cm
  - Q of mirror substrate:  $1e8$
  - Coating: tantala/silica
  - Coating loss angle:  $3e-4$  for silica,  $5e-4$  for tantala
  - Number of layers: 9 for ITM, 18 for ETM
  - Coating absorption: 0.5 ppm
  - Substrate absorption: 20 ppm/cm
- **Suspension parameters**
  - TM-IM fiber: 35 cm long, 1.6 mm dia.
  - IM temperature: 16.3 K
  - Heat extraction: 6580 W/m/K
  - Loss angle:  $5e-6/2e-7/7e-7$  for CuBe fiber?/sapphire fiber/sapphire blade
- **Inspirial range calculation**
  - SNR=8,  $f_{min}=10$  Hz, sky average constant 0.442478
- Seismic noise curve includes vertical coupling, vibration from heatlinks and Newtonian noise from surface and bulk

# KAGRA Cryopayload

Provided by T. Ushiba and T. Miyamoto

Platform  
(SUS, 65 kg)

Marionette  
(SUS, 22.5 kg)

Intermediate Mass  
(SUS, 20.1 kg,  
16.3 K)

Test Mass  
(Sapphire, 23 kg,  
21.5 K)

3 CuBe blade springs

MN suspended by 1 Maraging steel fiber  
(35 cm long, 2-7mm dia.)  
MRM suspended by 3 CuBe fibers

Heat link attached to MN

IM suspended by 4 CuBe fibers  
(24 cm long, 0.6 mm dia)  
IRM suspended by 4 CuBe fibers

4 sapphire blades

TM suspended by 4 sapphire fibers  
(35 cm long, 1.6 mm dia.)  
RM suspended by 4 CuBe fibers

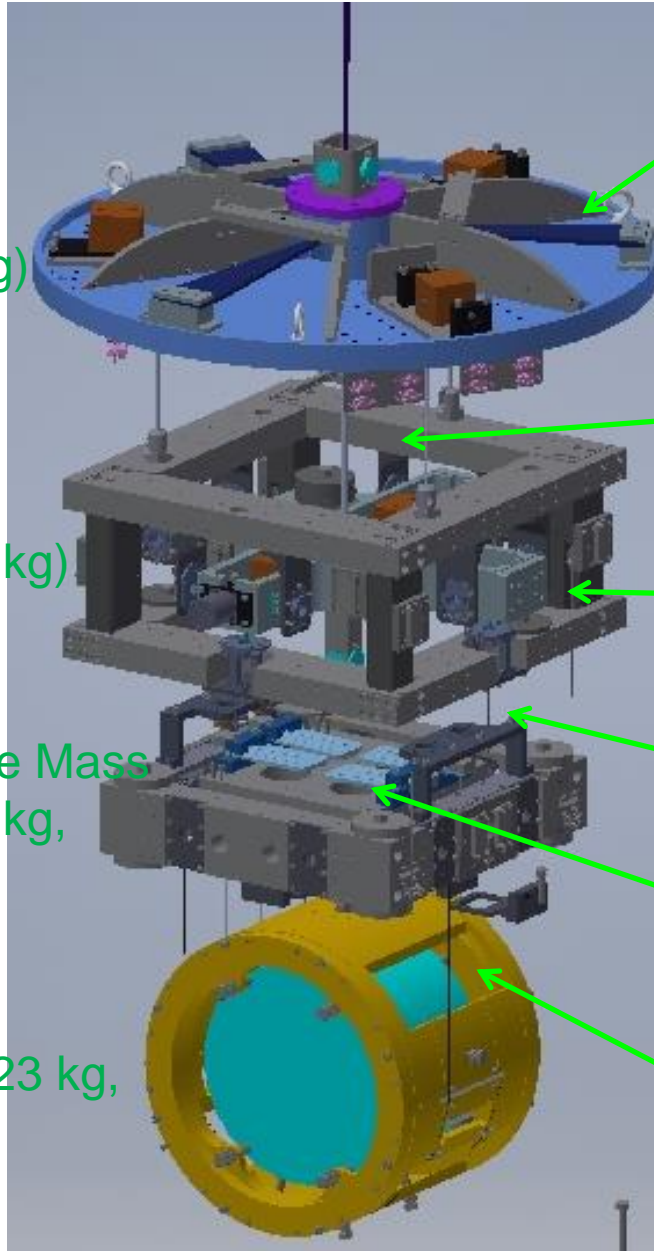

# Newtonian Noise from Water

- Measured  $v = 0.5 \sim 2$  m/s  $\rightarrow$  seems OK

$$\sqrt{S_h(\Omega)} = \frac{2G\rho w}{\Omega L v} K_0\left(\frac{\Omega D}{v}\right) \sqrt{S_b(\Omega)}$$

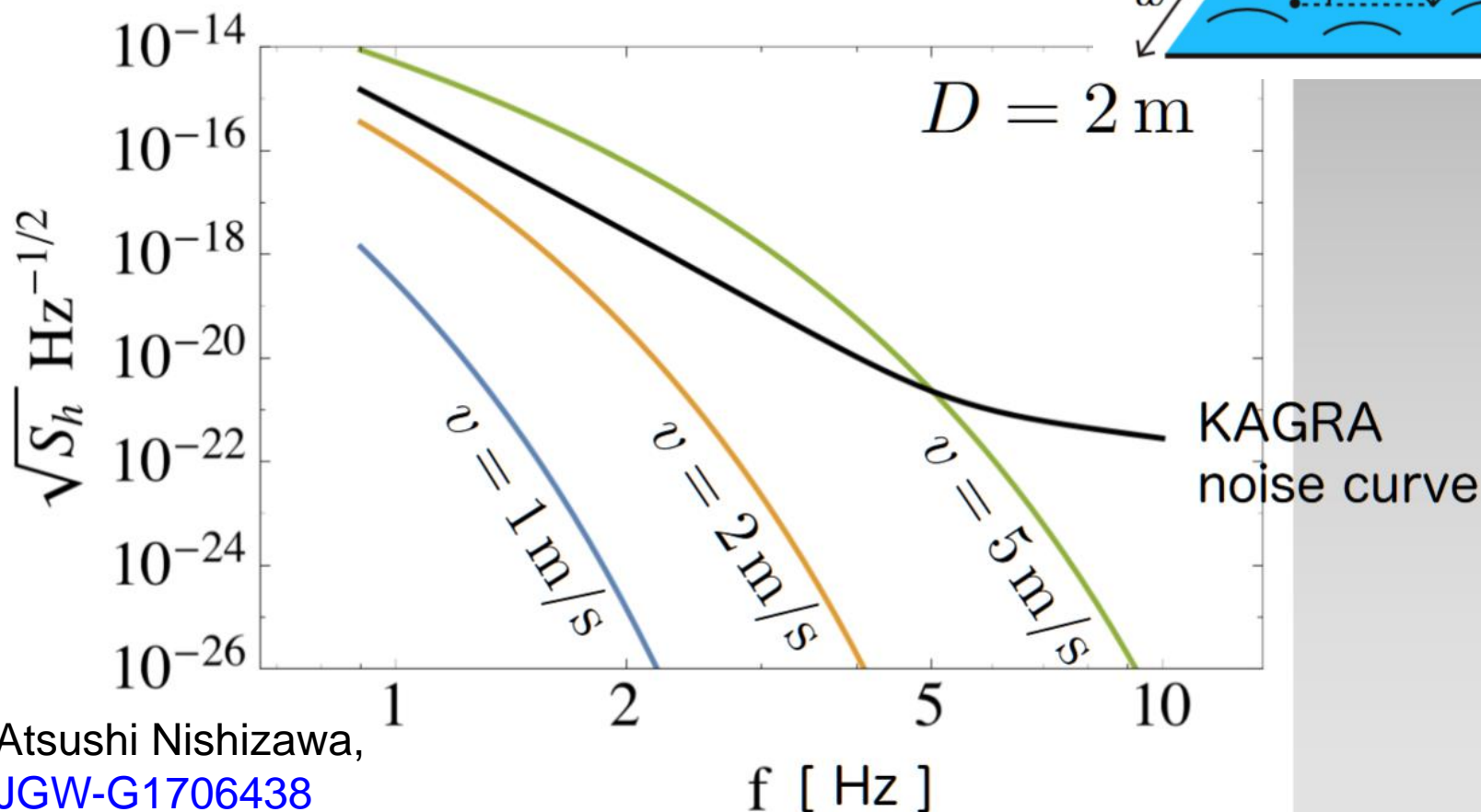
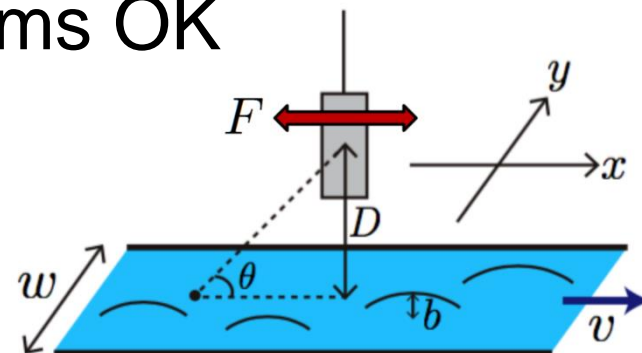

# 2-3G Sensitivity Comparison

