

Status of KAGRA

Yuta Michimura

Department of Physics, University of Tokyo

KAGRA Project

- Constructed in Kamioka mine
- **Underground** and **cryogenic**
- 300+ collaborators from 90+ institutes

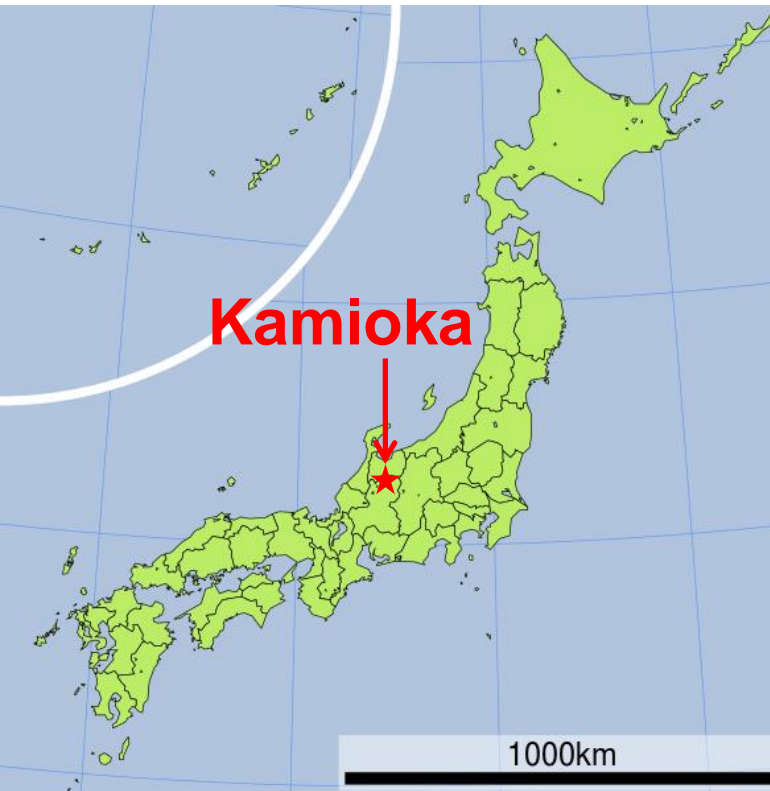

Roadmap of KAGRA

- **Completed first test run** at room temperature. Working for cryogenic test run.
- Baseline KAGRA (bKAGRA) in 3 phases.

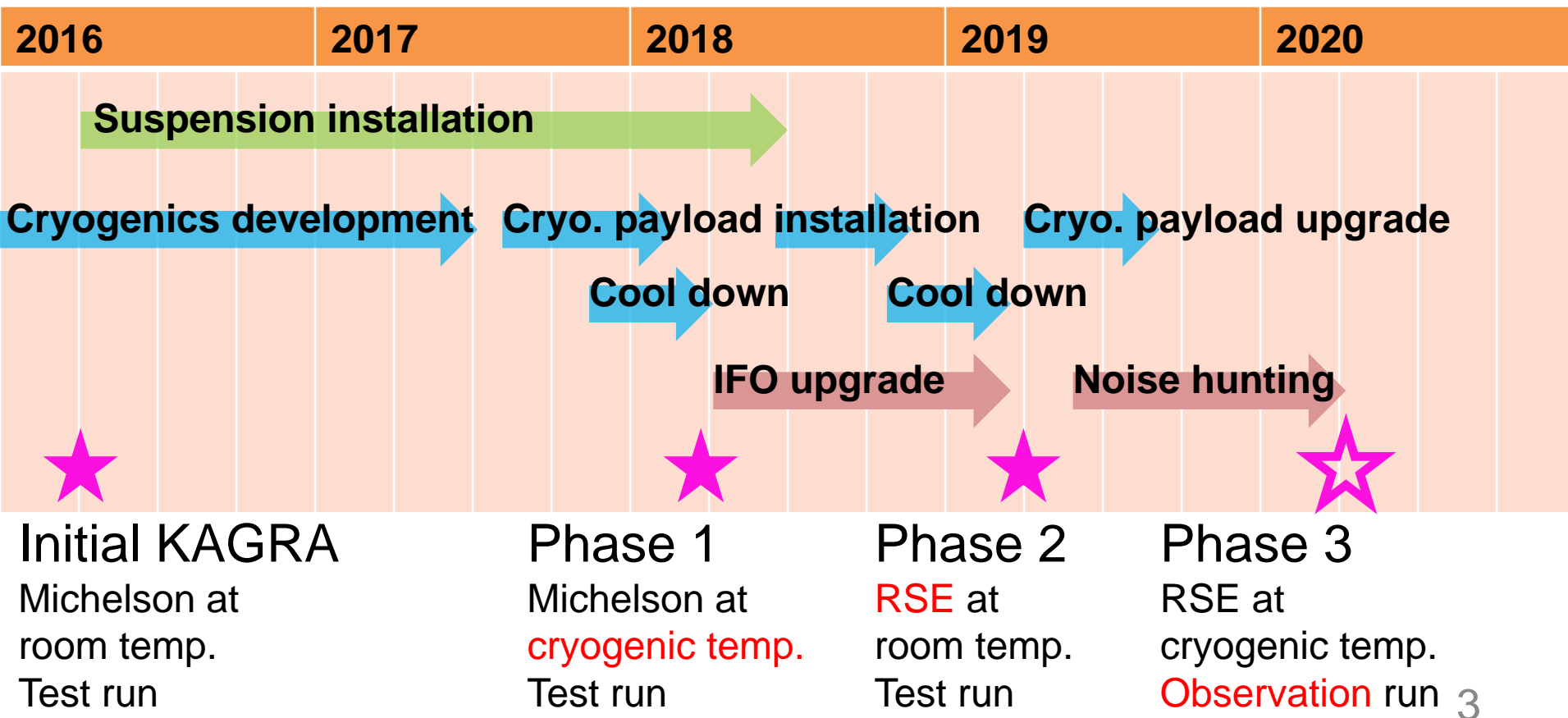

Observation Scenario

- With 25-40 Mpc in 2020, 40-140 Mpc in 2021

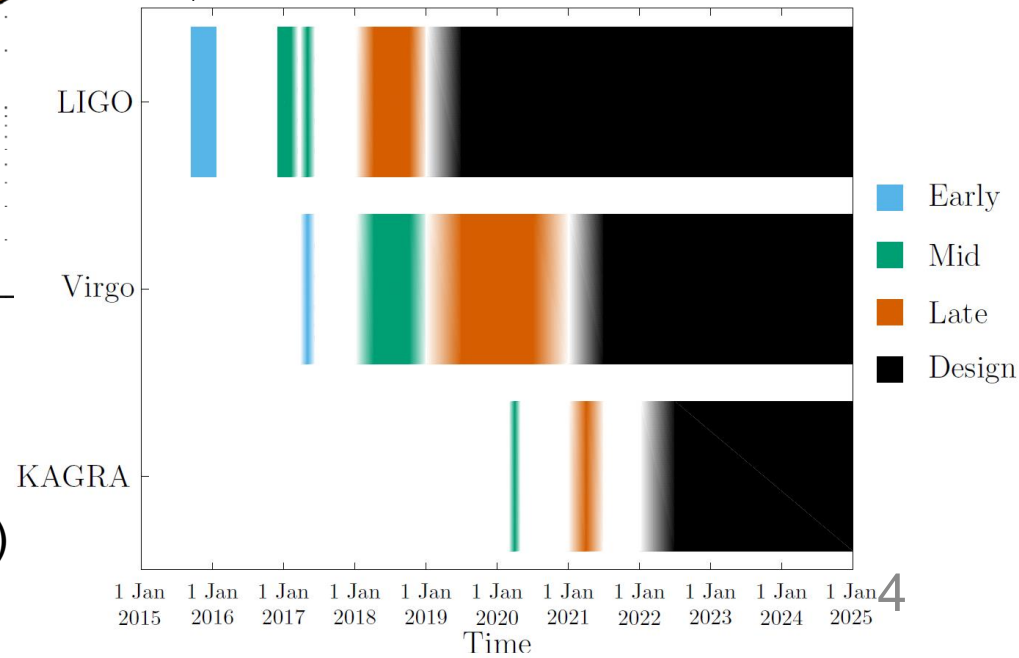
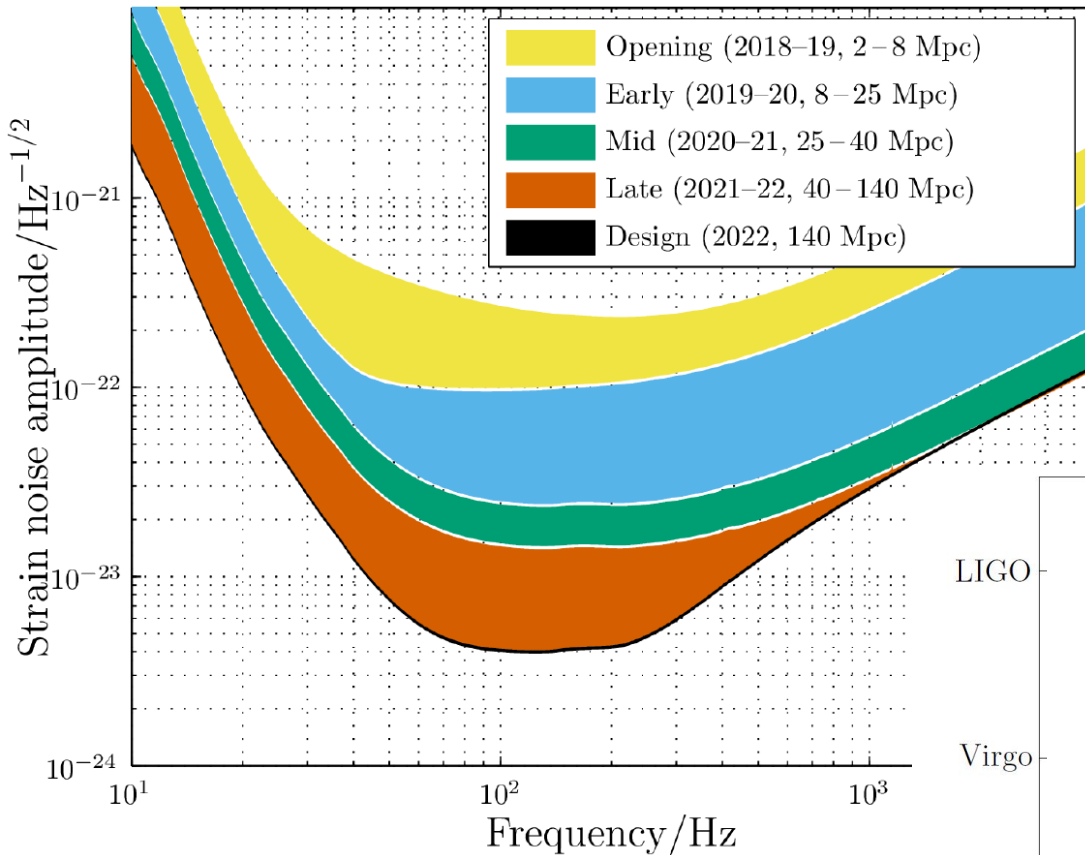

Living Reviews in Relativity 19, 1 (2016)
to be updated

KAGRA Full Configuration

- RSE interferometer
- Sapphire test masses at **23 K**

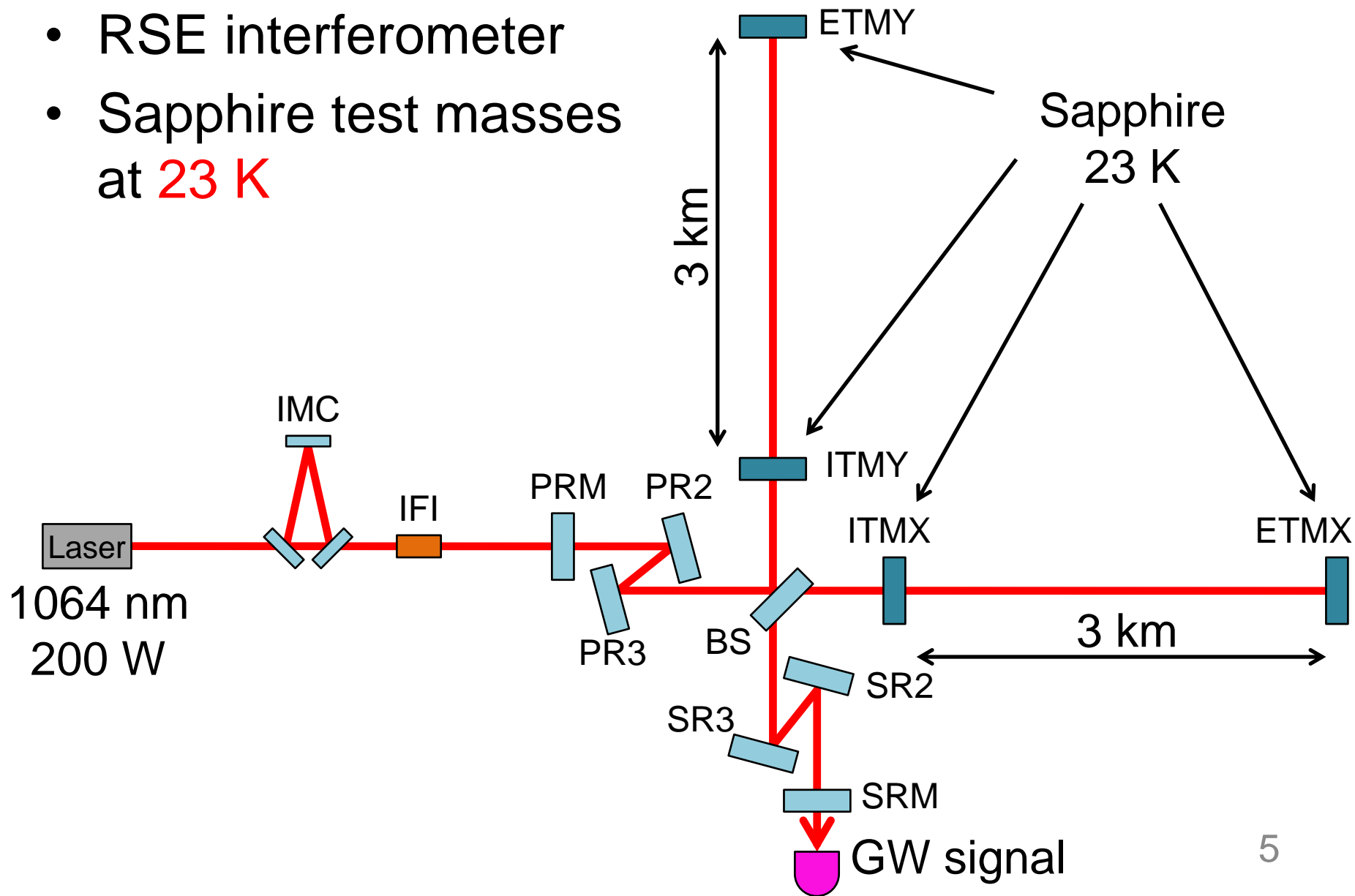

Initial KAGRA Configuration

- 3 km Michelson at room temperature
- Low power
- Simplified suspension
- At air pressure

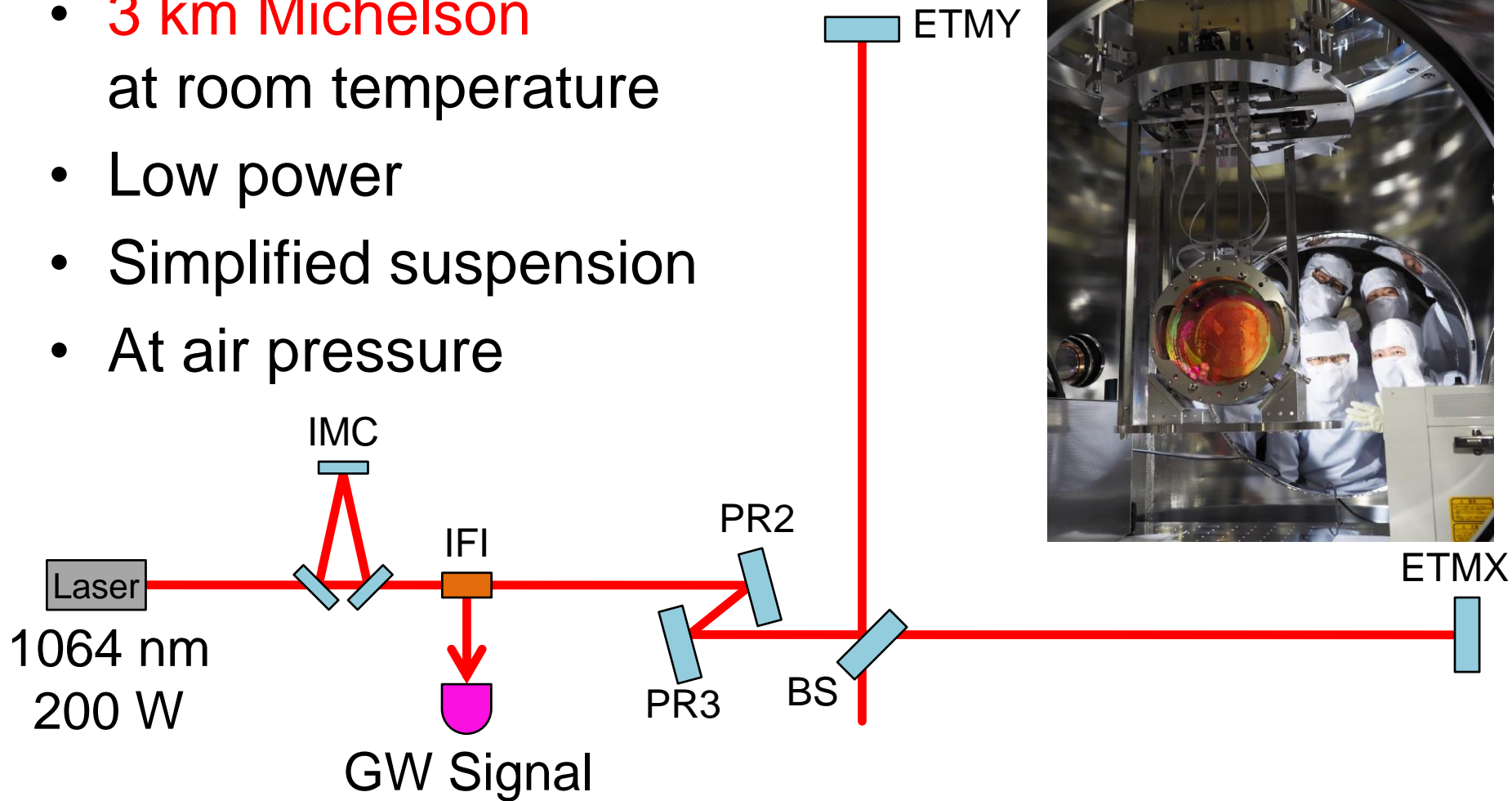

iKAGRA Test Run in 2016

- Period
 - March 25 to 31
 - April 11 to 25
- Purpose
 - confirm layout of the 3 km vacuum ducts
 - test controls, data transfer, observation shift, etc.
 - get environmental data
 - **obtain experiences** of the management and operation of the km-class interferometer



iKAGRA Sensitivity

- $\sim 3e-15$ /rtHz @ 100 Hz
- Limited by **seismic noise**, **acoustic noise** and **ADC noise**
- Reduction possible in bKAGRA

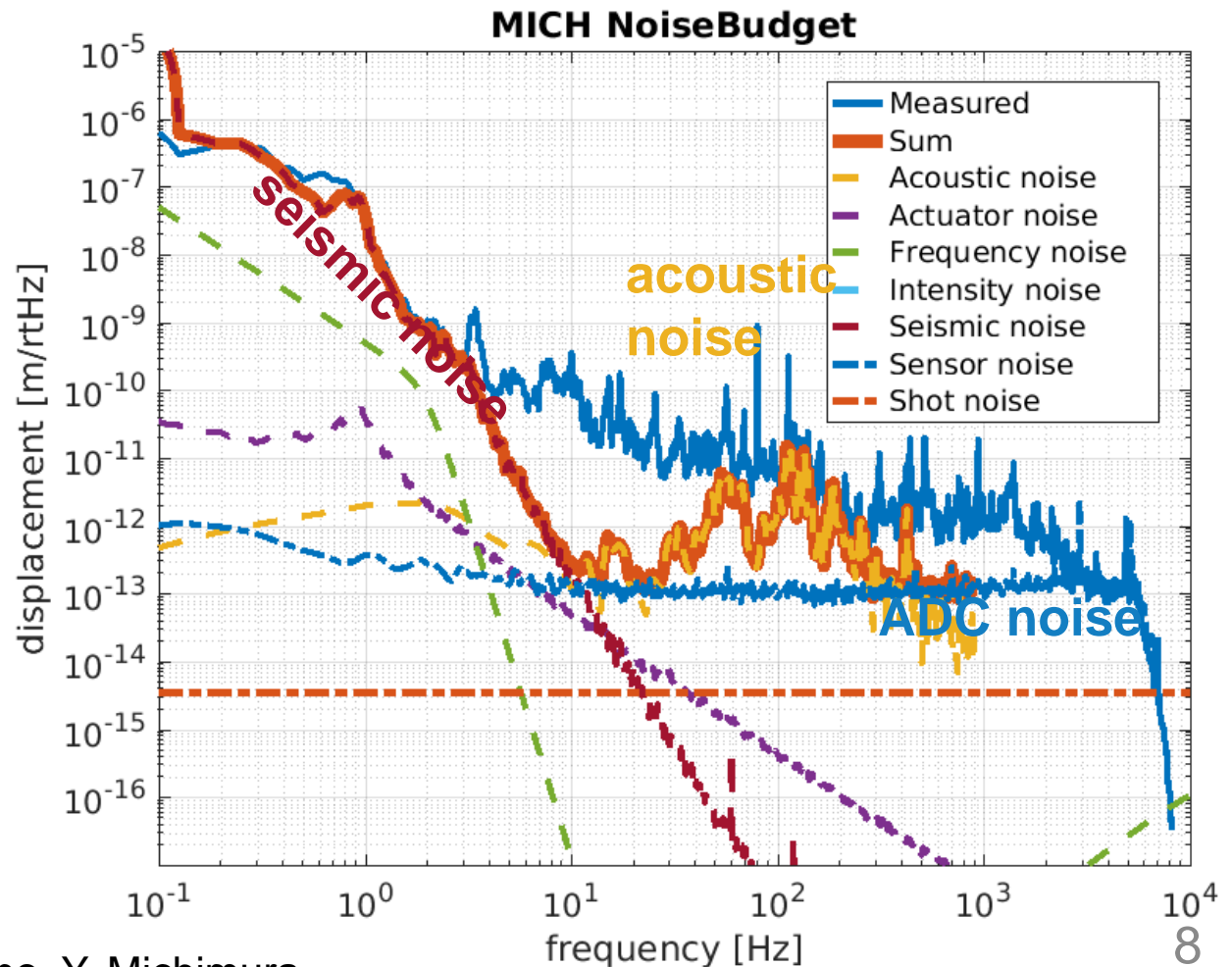

Data Transfer

- Real time transfer to **ICRR Kashiwa** and **Osaka City Univ.**
(~3 sec latency, ~ 200 MB/sec)
- Delayed mirroring at **Academia Sinica, Taiwan** and **KISTI, Daejeon**
- 7.5 TB in total

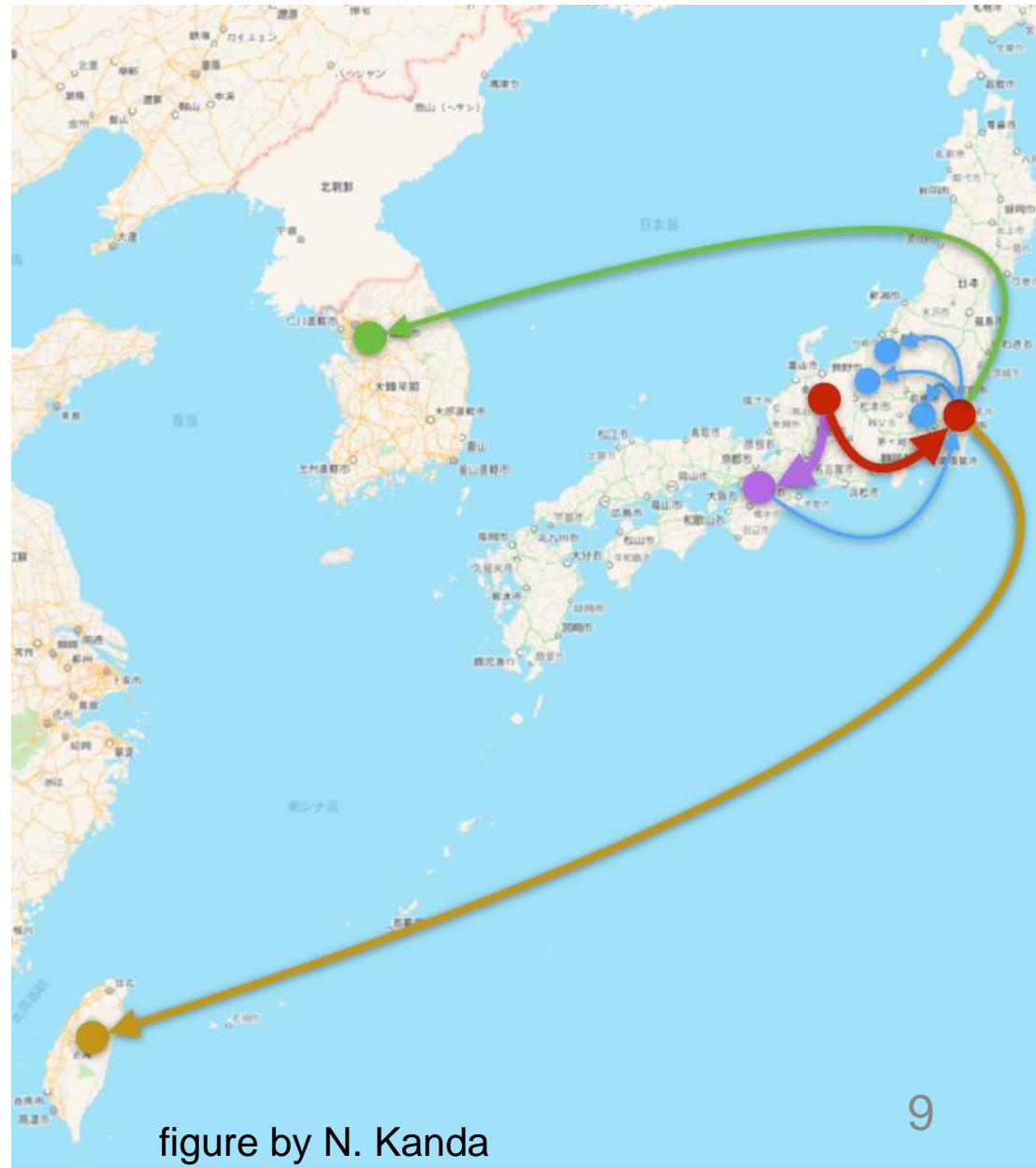

Hardware Injection

- Right after 2nd iKAGRA run
- Gravitational waveforms of CBC, Supernovae, etc.
- Important **end-to-end test**

signal injection

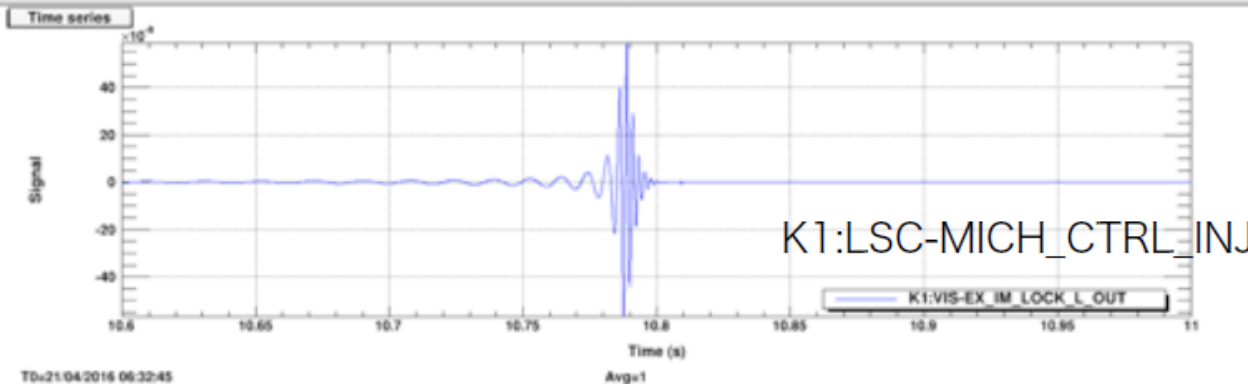
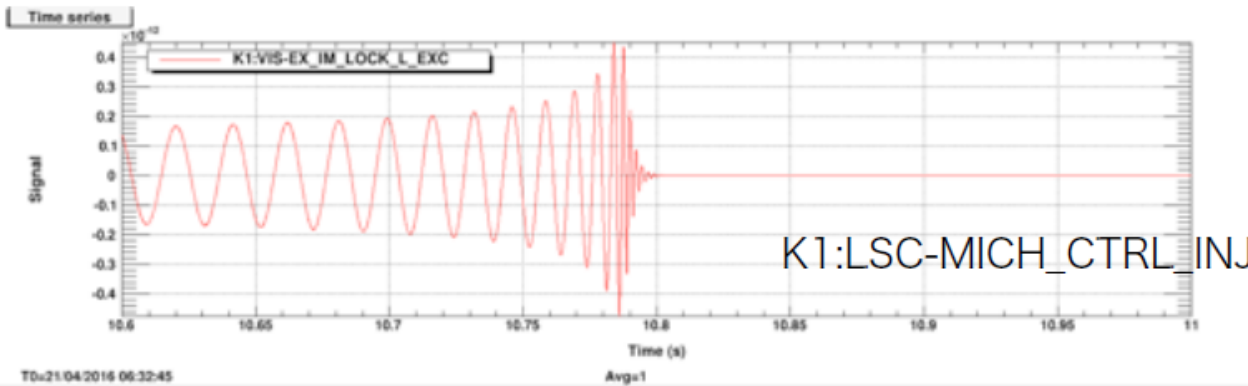
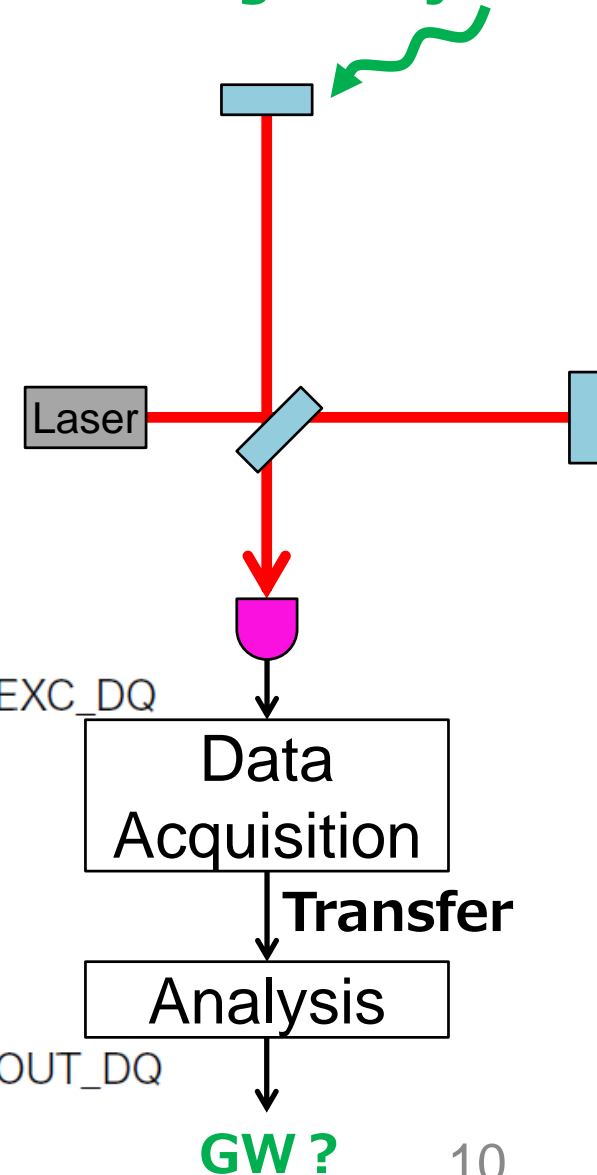

Next step: bKAGRA Phase 1

- 3 km Michelson
- Sapphire ETMs at **cryogenic** temperature
- Deadline: **March 2018**

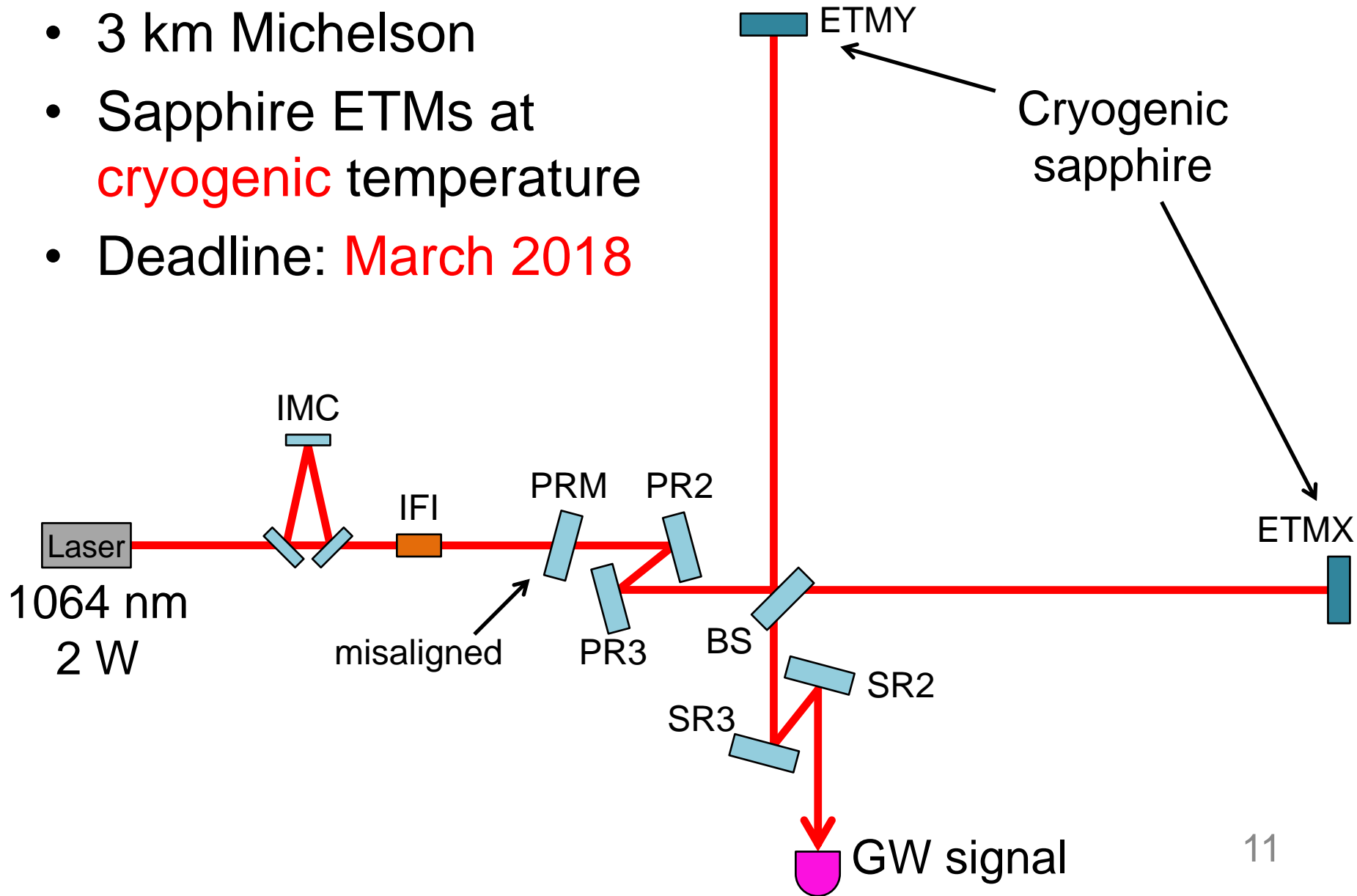

bKAGRA Phase 1 Schedule

- More suspensions, cryogenics, PSL upgrade

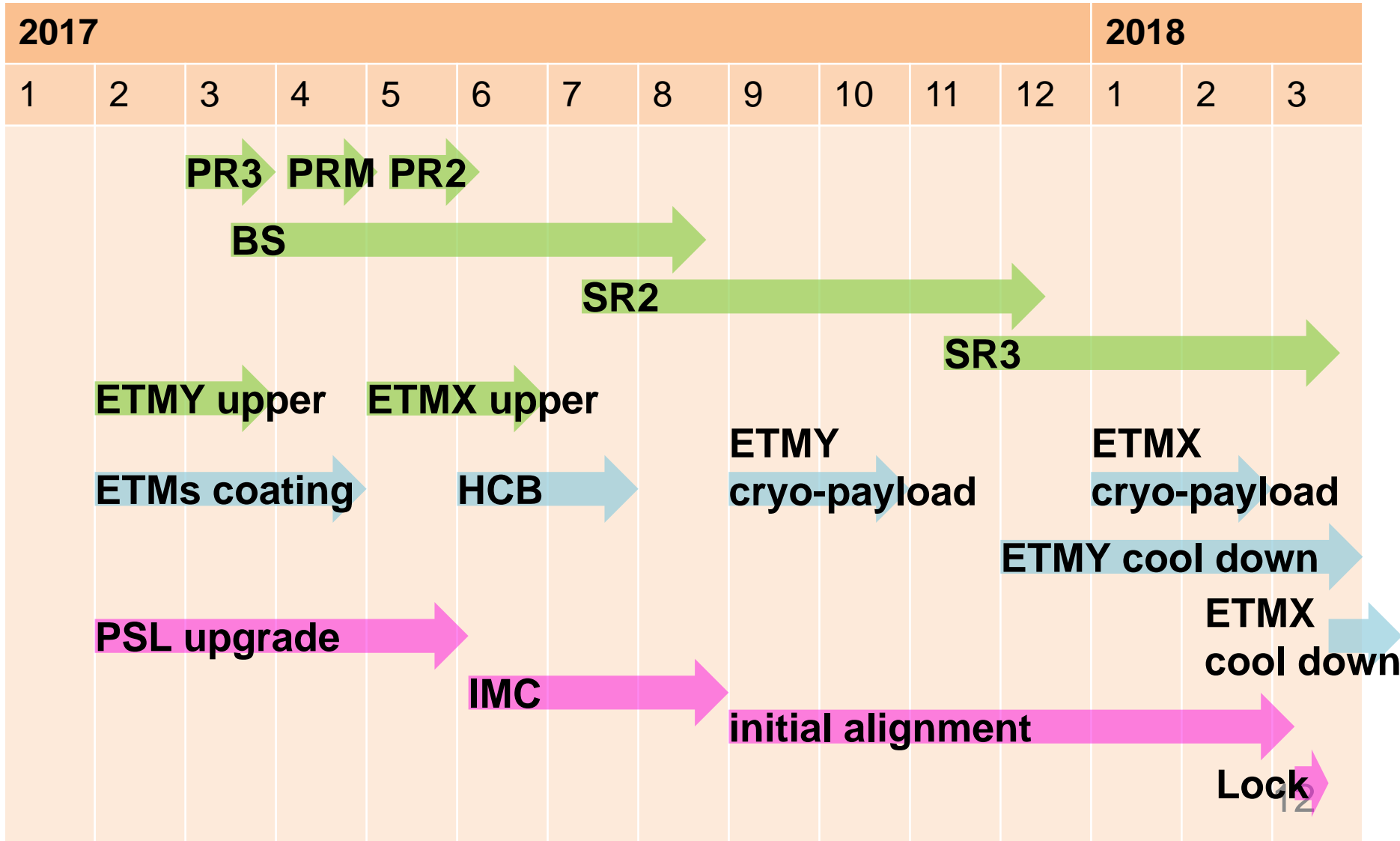

Suspension Installation

- Test hanging, pre-assembly on-going at the site

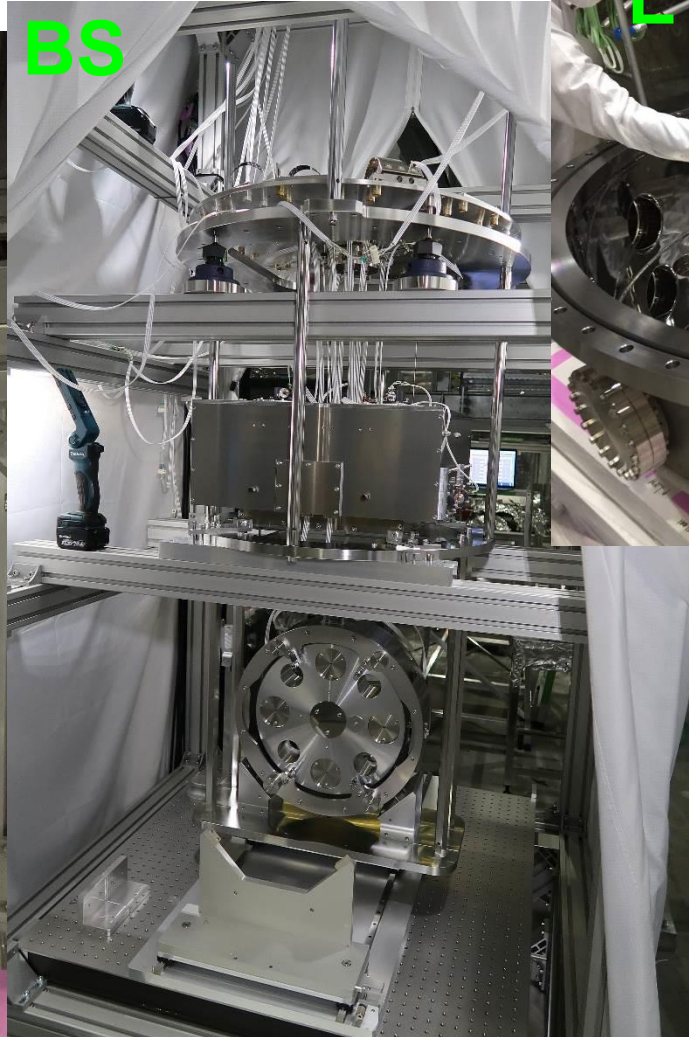
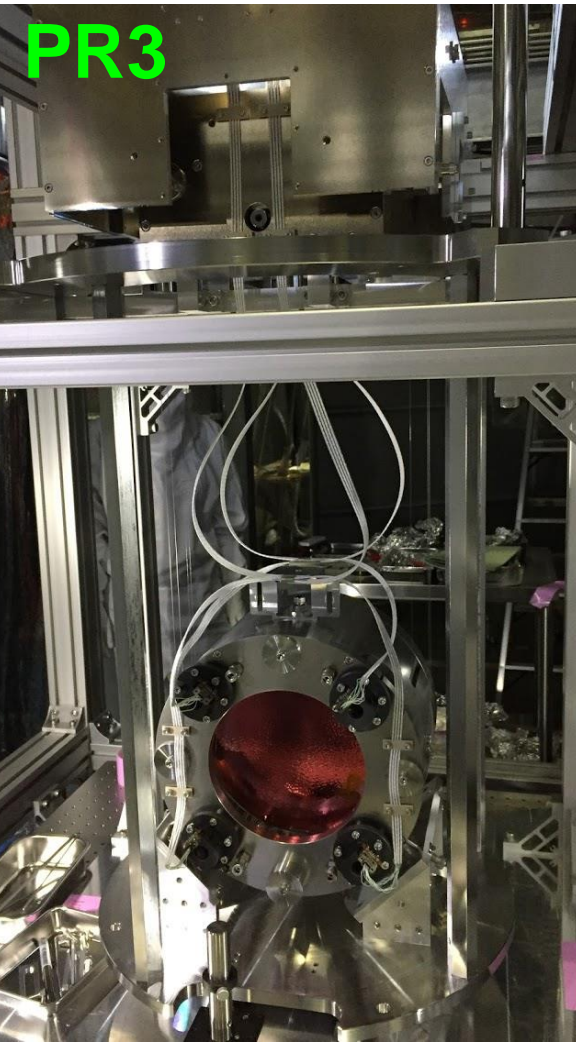

Cryogenics

- Magnetic noise, vibration measurements at cryostats at the site on-going
- Cryopayload test at KEK, HCB test at NAOJ
- Risk of ETM coating delay (preparing spares)

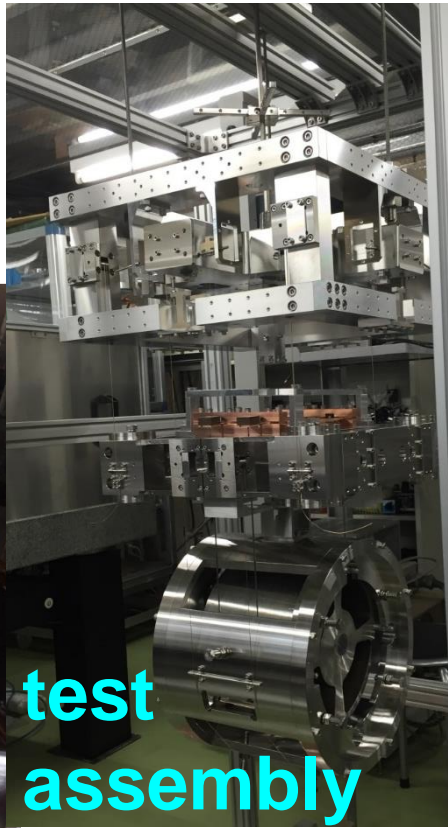
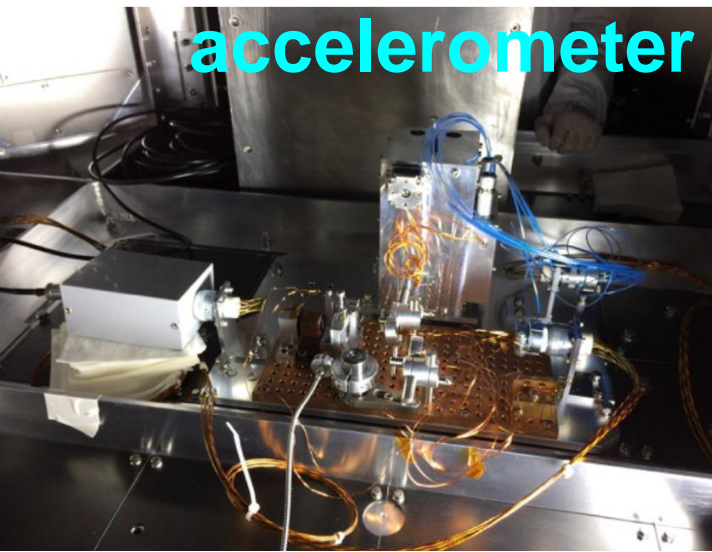

Input Optics Upgrade

- Input Mode Cleaner (IMC) magnets replaced
- Input Mode Matching Telescope (IMMT) suspensions installed
- iKAGRA Pre-stabilized Laser (PSL) disassembled, bKAGRA PSL being assembled

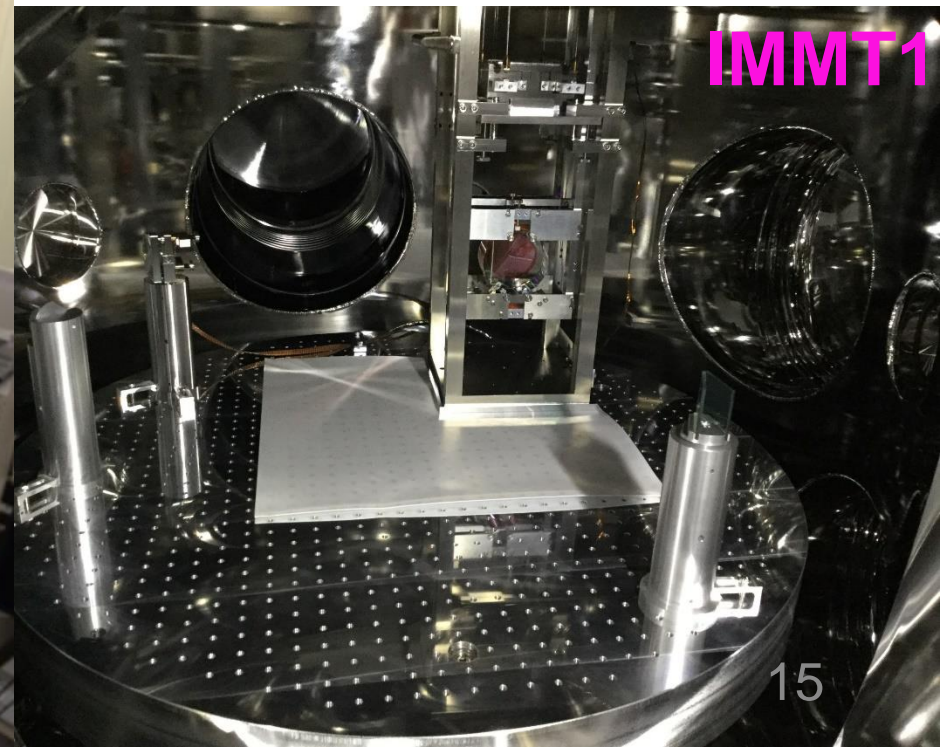
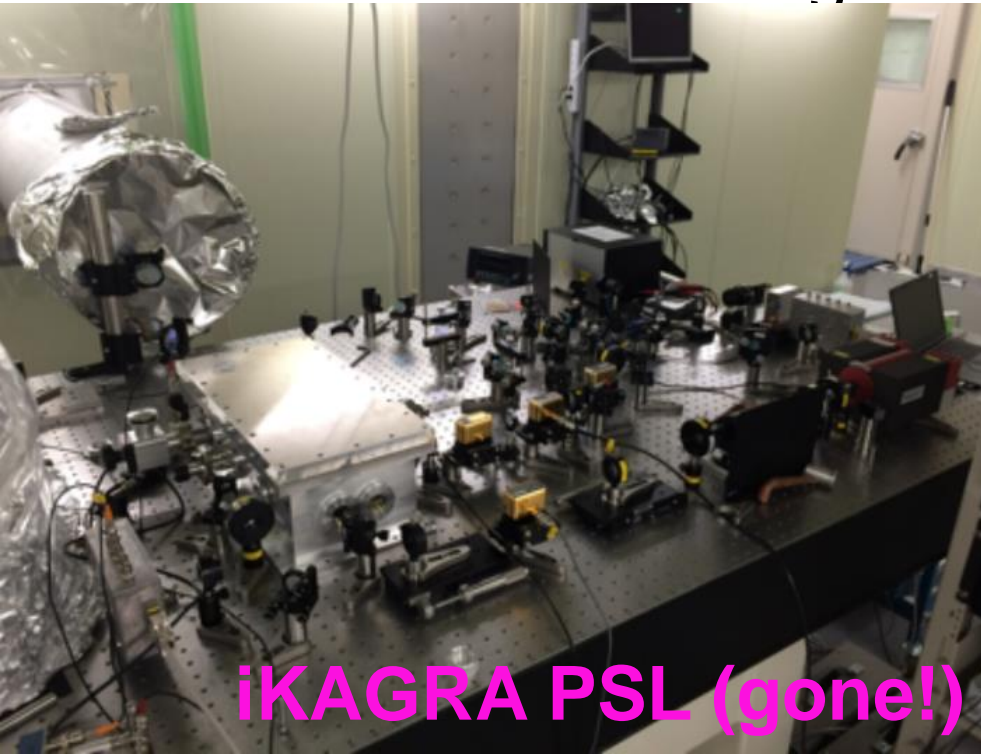

Summary

- Successfully completed the first test run at room temperature (iKAGRA)
- Working hard for the first cryogenic test run by March 2018 (bKAGRA Phase 1)
- The first observation run in ~2020
- Stay tuned to KAGRA elog (klog)
<http://klog.icrr.u-tokyo.ac.jp/osl/>

Extra Slides

KAGRA Sensitivity

- If sapphire mirrors are at 23 K,
input power is at 55 W

