

# 4 Feedthroughs

# TM OSEMs

TM OSEM to BF Cable  
JGW-D1503901 Sheet 01

### OSEM

Type 5-2.2

BF to F0 Signal Cable  
JGW-D1503901 Sheet 08

Type 3-4

PI-Flange Signal Cable  
JGW-D1503901 Sheet 11

Type 1

### Feedthrough

### Anti-Feedthrough Adapter Cable

### OSEM External Cable

Sat Amp #0  
D1402809

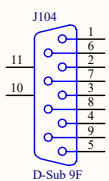
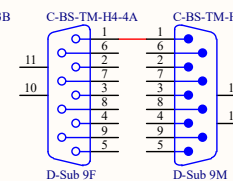
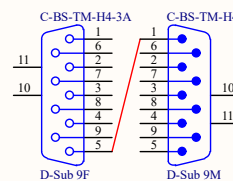
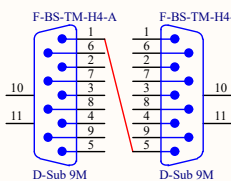
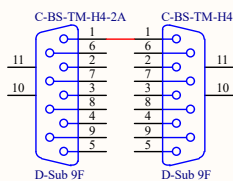
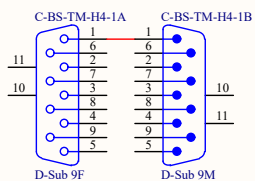
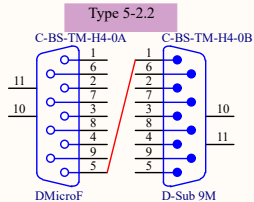
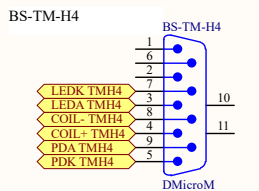
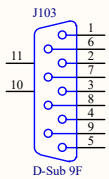
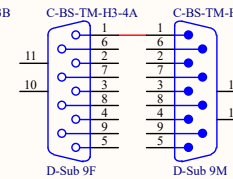
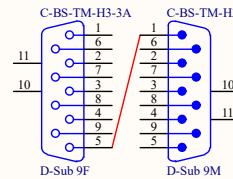
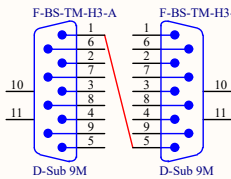
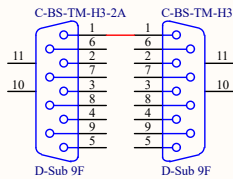
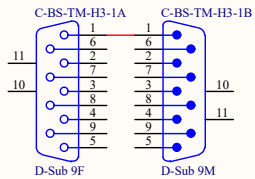
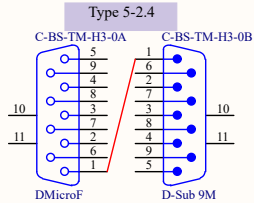
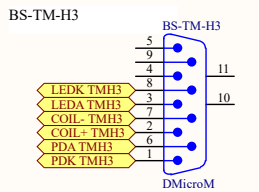
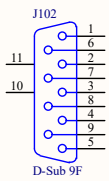
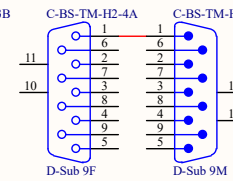
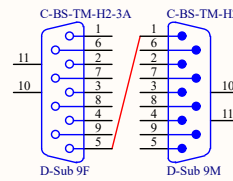
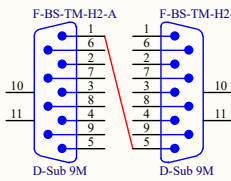
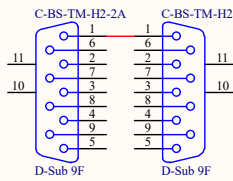
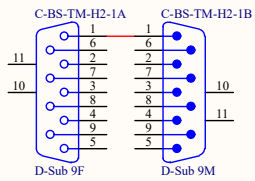
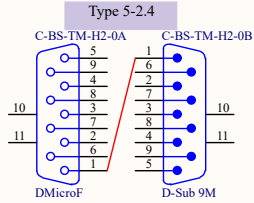
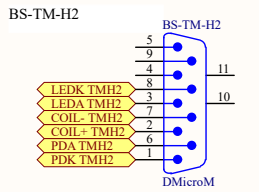
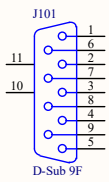
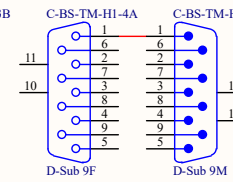
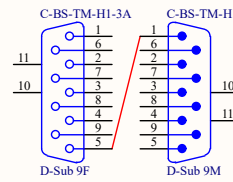
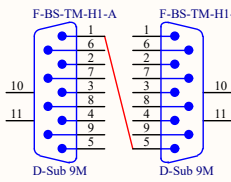
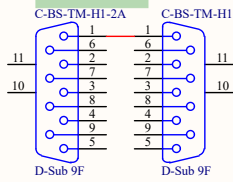
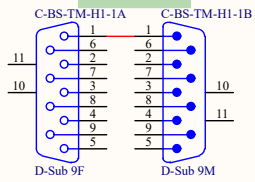
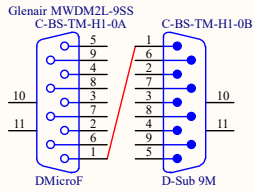
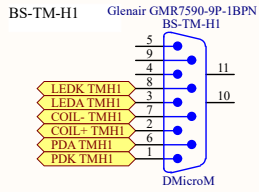

Type 5 cables have a flip to correct flexicircuit issue.

Each OSEM has a D-Micro male, which looks superficially like a female but has pins in recesses. The OSEM and cable were both shown with the wrong gender until -v13 of this diagram.

Title BS Suspension Cabling - Test Mass OSEMs		
Size A3	Number JGW-D1503600	Revision -v13
Date: 2017/04/27	Sheet 1 of 18	
File: \\..01.TM OSEMs.SchDoc	Drawn By:	

# 6 Feedthroughs

## IM OSEMs

IM OSEM to BF Cable  
JGW-D1503901 Sheet 02

BF to F0 Signal Cable  
JGW-D1503901 Sheet 08

PI-Flange Signal Cable  
JGW-D1503901 Sheet 11

Feedthrough

Anti-Feedthrough Adapter Cable

OSEM External Cable

Sat Amp #1  
D1402809

OSEM

Type 5-1.6

Type 3-4

Type 1-2

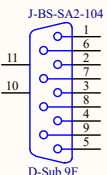
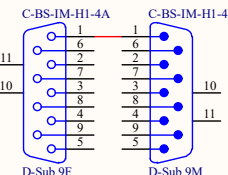
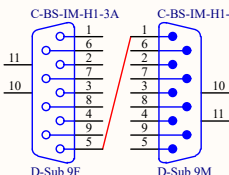
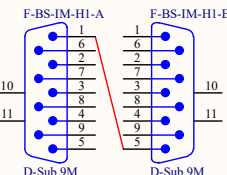
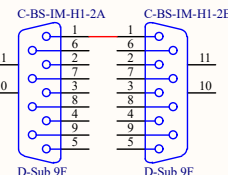
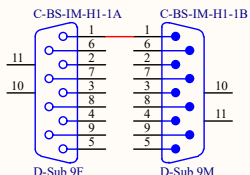
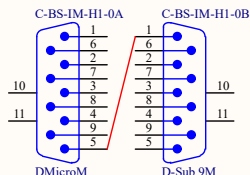
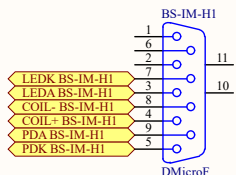
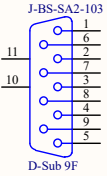
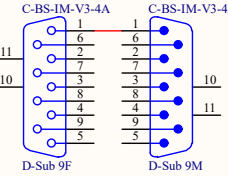
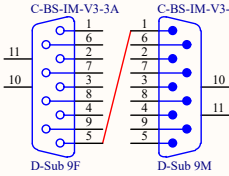
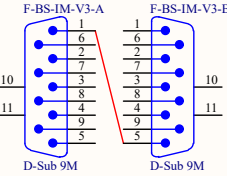
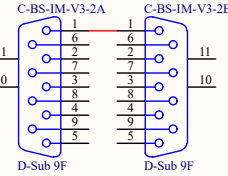
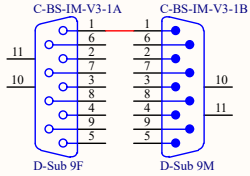
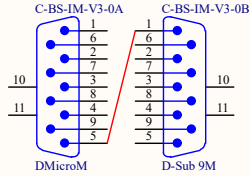
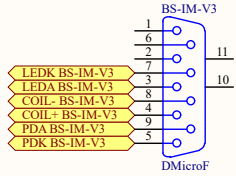
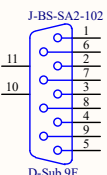
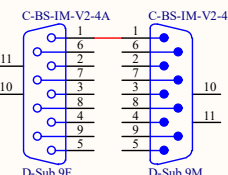
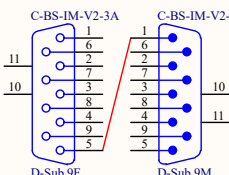
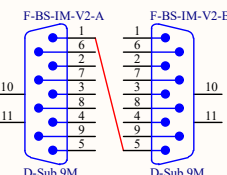
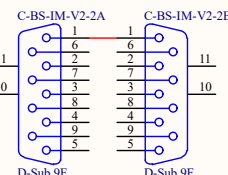
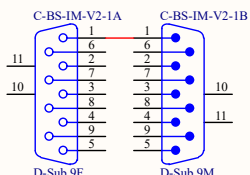
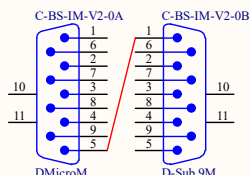
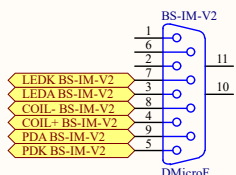
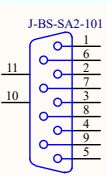
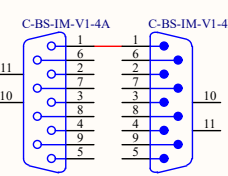
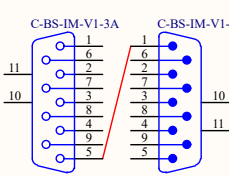
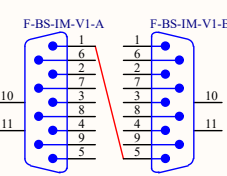
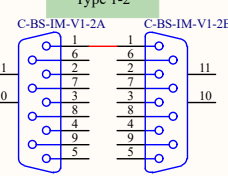
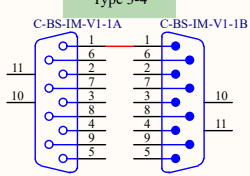
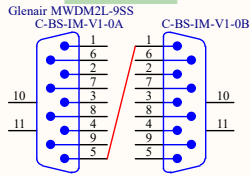
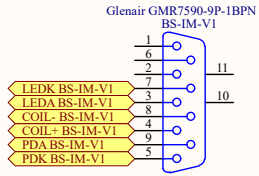

Type 5-1.6

Type 3-4

Type 1-2

Sat Amp #2  
D1402809

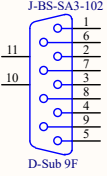
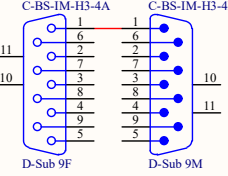
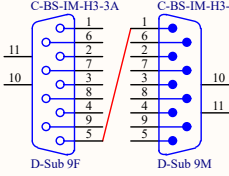
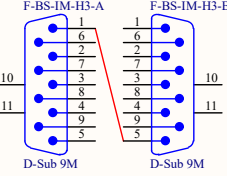
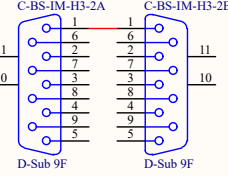
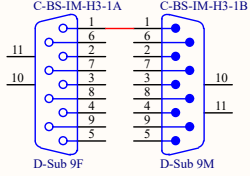
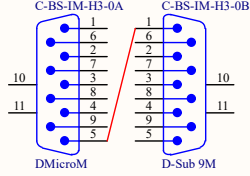
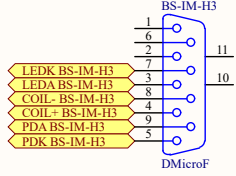
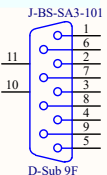
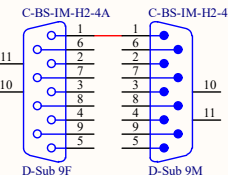
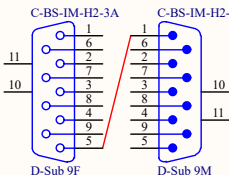
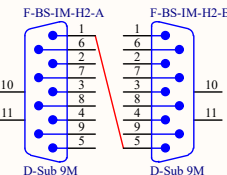
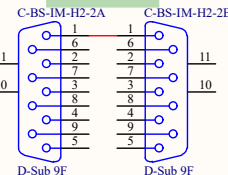
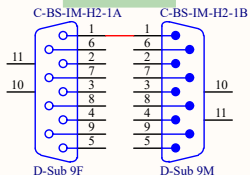
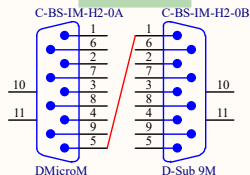
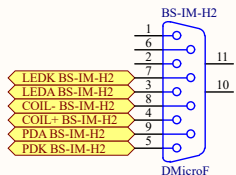

J-BS-SA3-103 and J-BS-SA3-104 not used

Type 5 cables have a flip to correct flexicircuit issue.

Each OSEM has a D-Micro male, which looks superficially like a female but has pins in recesses. The OSEM and cable were both shown with the wrong gender until -v13 of this diagram

Title BS Suspension Cabling - Intermediate Mass OSEMs		
Size A3	Number JGW-D1503600	Revision -v13
Date 2017/04/27	Sheet 3 of 18	Drawn By:
File: \\...02 IM OSEMs.SchDoc		

# 1 Feedthrough

## IM Picomotors & BF Yaw Picomotor

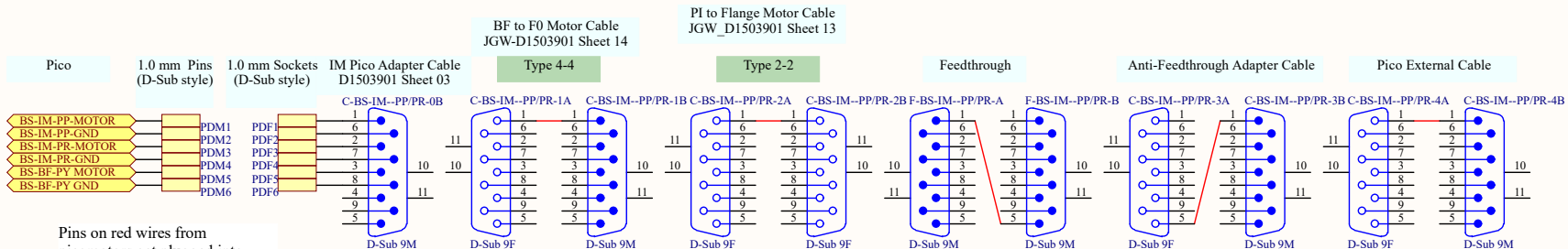

Pins on red wires from picomotors get plugged into sockets from pins 1, 2, 3.

Pins on white wires from picomotors get plugged into sockets from pins 6, 7, 8.

The pico motor at the bottom level of the IM does pitch and gets plugged into 1&6.

The pico motor at the top level of the IM does roll and gets plugged into 2&7.

The pico motor in the BS does IM yaw and gets plugged into 3&8.

The connectors for the pico drivers are RJ22 with four pins. I couldn't find Altium versions, so I used a random four-pin connector.

The adapter cable is made by combining the cables supplied by the pico manufacturer (Newport) with a D-Sub 9 female.

Green wires from manufacturer's cables get soldered to pins 1, 2.

Yellow wires from manufacturer's cables get soldered to pins 6, 7.

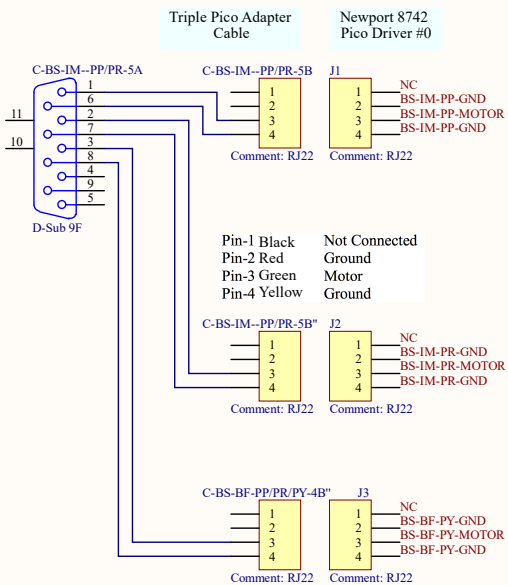

In ~v10, the BS Yaw Pico was moved to the IM sheet and grouped with the IM picos, because it's more physically convenient for wiring and more logical (it actually rotates the IM).

Title BS Suspension Cabling - IM Picos and BF Yaw Pico			
Size A3	Number JGW-D1503600	Revision -v13	
Date: 2017/04/27	Sheet 3 of 18		
File: \\.\03 IM Picos & BF Yaw Pico.SchDoc	Drawn By:		

### 3 Feedthroughs

In -v10, the BS Yaw Pico was moved to the IM sheet and grouped with the IM picos, because it's more physically convenient for wiring and more logical (it actually rotates the IM).

## BF and F1 Picomotors and Steppers

The connectors for the pico drivers are RJ22 with four pins. I couldn't find Altium versions, so I used a random four-pin connector.

Pin-1 Black Not Connected  
Pin-2 Red Ground  
Pin-3 Green Motor  
Pin-4 Yellow Ground

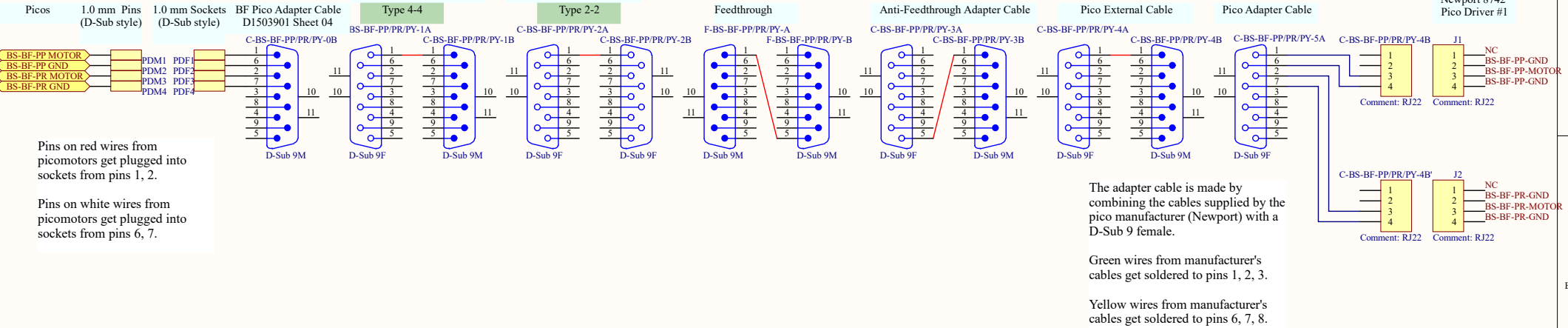



# GAS (BF, F1 and F0) LVDT/ACTs

## 2 Feedthroughs

LVDT/ACT Distributor - see also Sheet 12  
 Chassis: JGW-D1402124  
 Front Panel: JGW-D1402827  
 Rear Panel: JGW-D1402828  
 Board: JGW-D1402117

LVDT/Act  
BF GAS

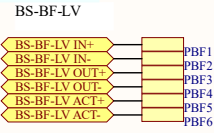

BF&F1 LVDT Adapter Cable  
JGW-D1503901 Sheet 06

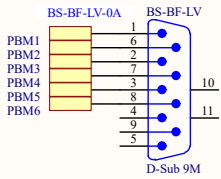

BF-F0 Signal Cable  
JGW-D1503901 Sheet 08

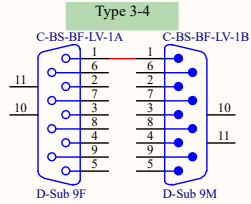

PI-Flange Signal Cable  
JGW\_D1503901 Sheet 11

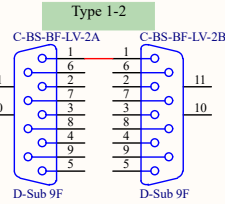

Feedthrough

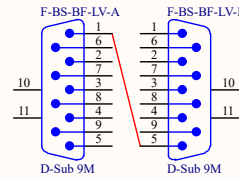

Feedthrough Adapter Cable

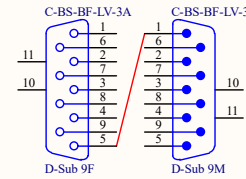

External Cable

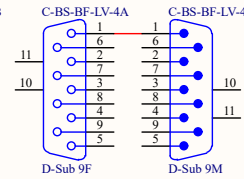

Ch 0

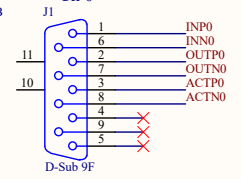

LVDT/Act  
F1 GAS

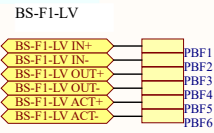

BF&F1 LVDT Adapter Cable  
JGW-D1503901 Sheet 06

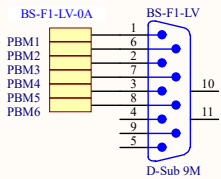

BF-F0 Signal Cable  
JGW-D1503901 Sheet 08

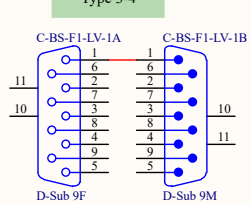

PI-Flange Signal Cable  
JGW\_D1503901 Sheet 13

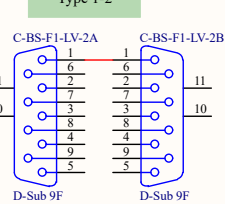

Feedthrough

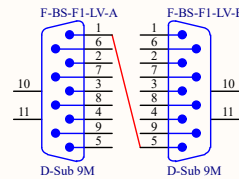

Feedthrough Adapter Cable

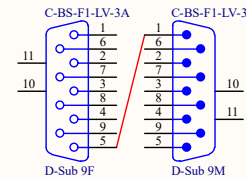

External Cable

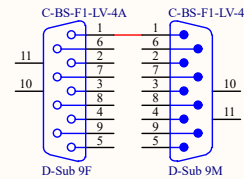

Ch 1

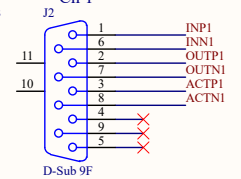

LVDT/Act  
F0 GAS

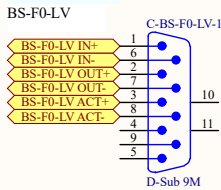

OPTIONAL  
Signal Cable Extension  
JGW\_D1503901 Sheet 10

Type 1-2

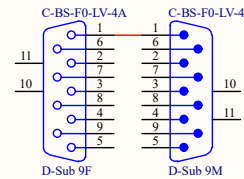
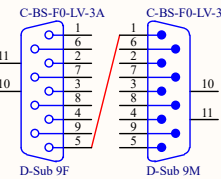
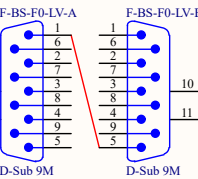
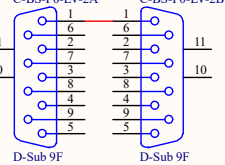

(Unused)

Ch 2

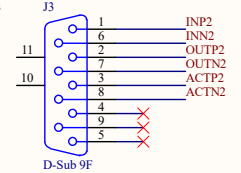

Ch 3

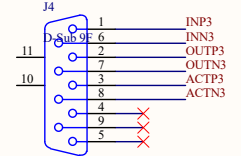

Title			BS Suspension Cabling - GAS LVDTs		
Size	Number	Revision			
A3	JGW-D1503600	-v13			
Date:	2017/04/27	Sheet	5 of 18		
File:	\\.\05 GAS LVDTs.SchDoc	Drawn By:			

4 Feedthroughs

Preisolator LVDT/ACTs

LVDT/ACT Distributor - see also Sheet 13  
 Chassis: JGW-D1402124  
 Front Panel: JGW-D1402827  
 Rear Panel: JGW-D1402828  
 Board: JGW-D1402117

LVDT/ACT

OPTIONAL  
 Signal Cable Extension  
 JGW\_D1503901 Sheet 10

PI-Flange Signal Cable  
 JGW\_D1503901 Sheet 11

Feedthrough

Anti-Feedthrough Adapter Cable

LVDT/ACT External Cable

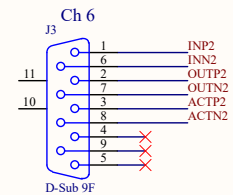
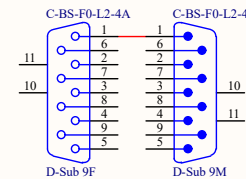
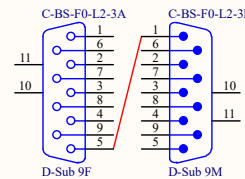
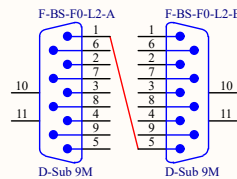
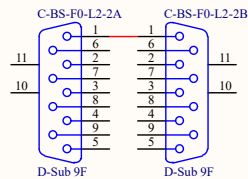
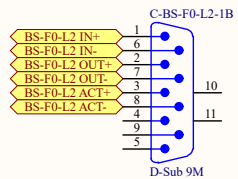
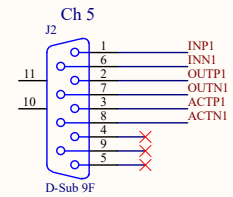
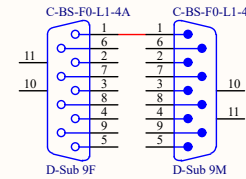
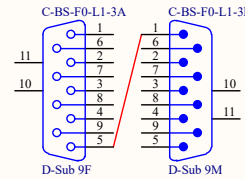
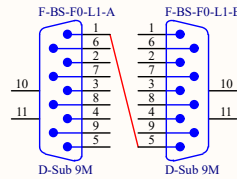
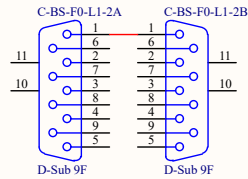
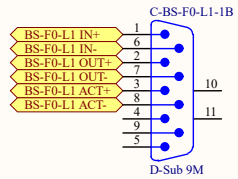
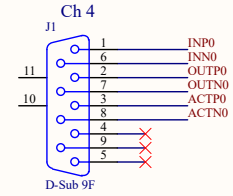
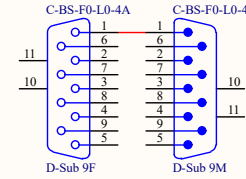
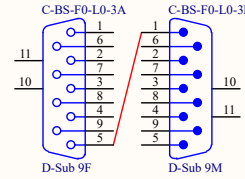
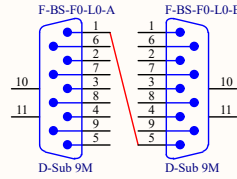
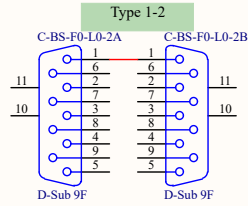
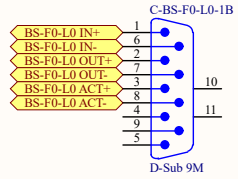

LVDT-COIL

Pin	Function
1	LVDT IN P
2	LVDT OUT P
3	COIL P
4	
5	
6	LVDT IN N
7	LVDT OUT N
8	COIL N
9	

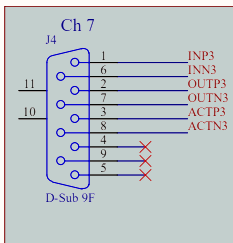

Title			
BS Suspension Cabling - Preisolator LVDT/Actuators			
Size	Number	Revision	
A3	JGW-D1503600	-v13	
Date:	2017/04/27	Sheet 6 of 18	
File:	\\.\06 F0 LVDTs.SchDoc	Drawn By:	

# 4 Feedthroughs

The vertical and yaw steppers have no limit switches and are combined on a single cable that VIS needs to provide.

# Preisolator Steppers

TMCM-6110  
Stepper Driver #2

Stepper Splitter Cable  
Double Motor Version

Stepper Driver #1  
Chassis: JGW-D1605365  
Board: TMCM-6110  
Serial-Internet Converter:  
MOXA NPort 5100A

Stepper

F0 Stepper Adapter  
JGW-D1503901 Sheet 24

The horizontal steppers have limit switches and will be wired as indicated by the IP manufacturer.

Pin	Function
1	COIL A P
2	COIL B P
3	Switch 1 P
4	Switch 2 P
5	
6	COIL A N
7	COIL B N
8	Switch 1 N
9	Switch 2 N

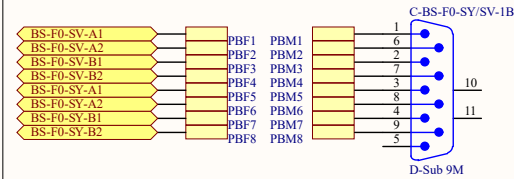
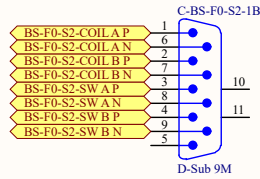
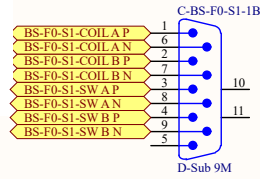
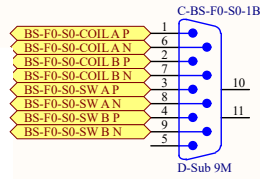

OPTIONAL  
Motor Cable Extension  
JGW\_D1503901 Sheet 16

PI to Flange Motor Cable  
JGW-D1503901 Sheet 13

Type 2-2

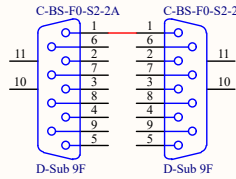
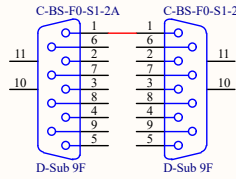
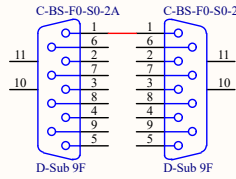

PI to Flange Motor Cable  
JGW-D1503901 Sheet 13

C-BS-F0-SY/SV-2A

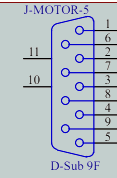
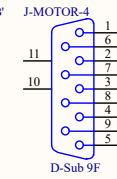
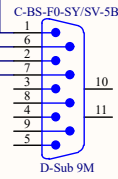
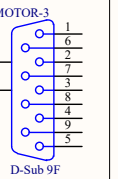
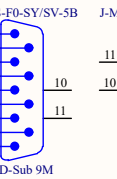
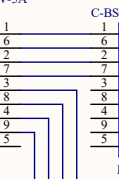
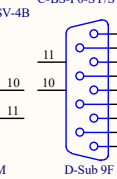
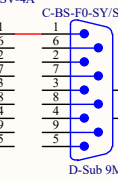
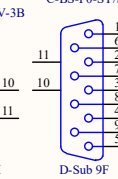
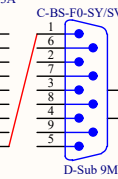
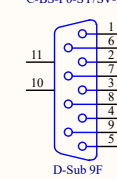
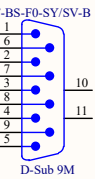
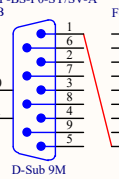
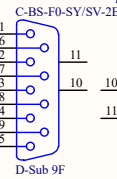

Title		
BS Suspension Cabling - Preisolator Steppers		
Size	Number	Revision
A3	JGW-D1503600	-v13
Date:	2017/04/27	Sheet 7 of 18
File:	\\..07 F0 Steppers.SchDoc	Drawn By:

# 3 Feedthroughs

# Preisolator Geophones

Geophone Pod Internal Cabling  
(same for all three pods):

Pod #1: geophone L400002322, preamp 15  
Pod #2: geophone L400002321, preamp 12  
Pod #3: geophone L400002323, preamp 14



## Geophone Pod

Geophone Adapter Cable  
JGW-D1503901 Sheet 07

PI to Flange Geophone Cable  
JGW-E1503901 Sheet 11

Feedthrough

Anti-Feedthrough Adapter Cable

Geophone External Cable

Geophone Unscrambler  
Cable

Geophone Distributor  
JGW-D1402120

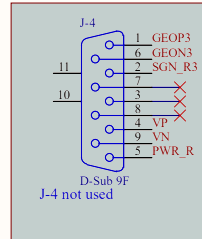
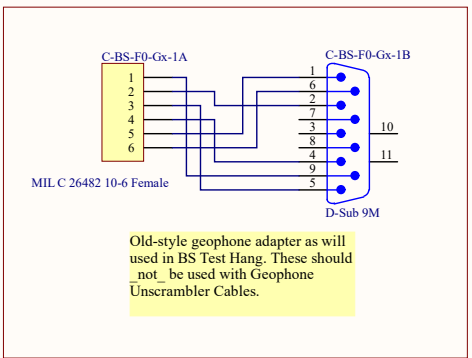
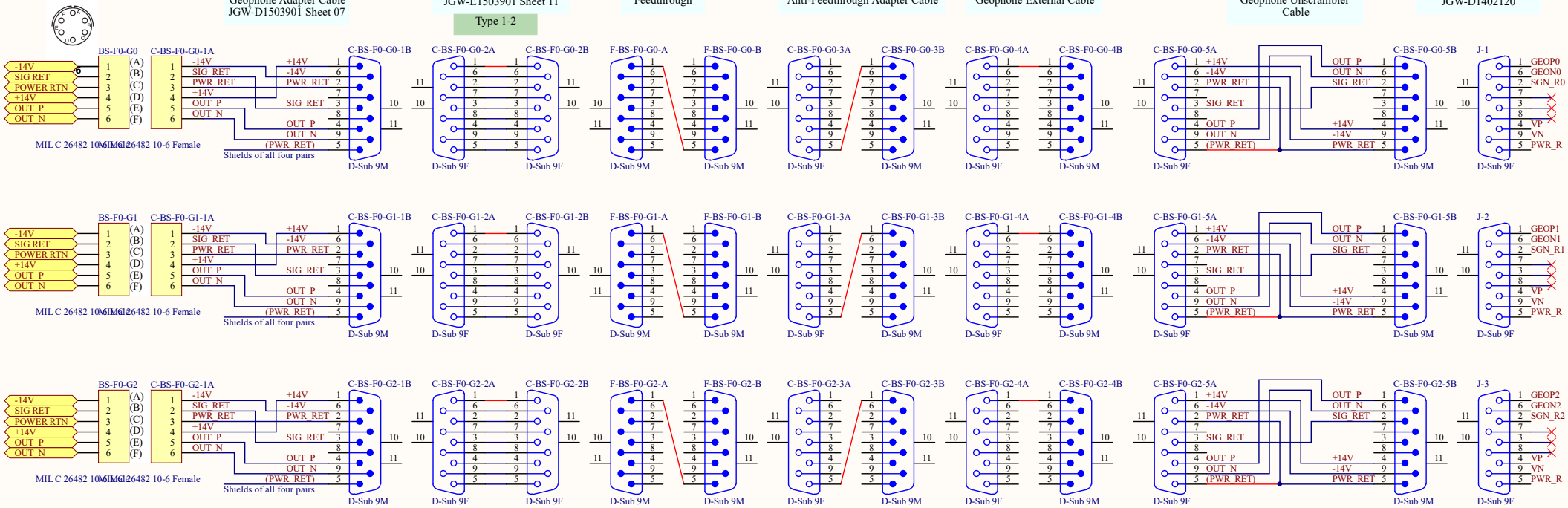

Title BS Suspension Cabling - Preisolator Geophones			
Size A3	Number JGW-D1503600	Revision -v13	
Date: 2017/04/27	Sheet 8of 18	Drawn By:	
File: \\..08 F0 Geophones.SchDoc			

# OSEM Sat Amp and Driver - TM

## Sat Amp #0

Chassis: JGW-D1503498,  
Front Panel: JGW-D1503500,  
Rear Panel: JGW-D1503500,  
Board: JGW-D1503499

Inputs from TM  
OSEMs  
(see Sheet 1)

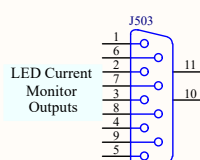
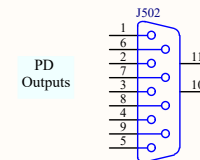
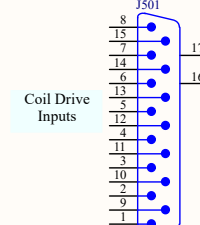
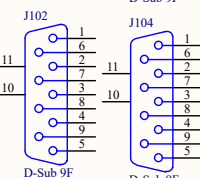
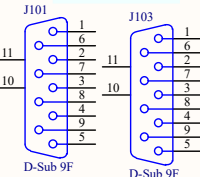

## AI Chassis #0 D1100650

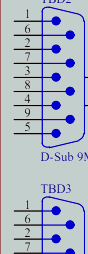
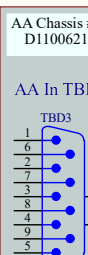
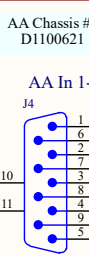
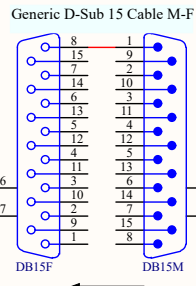
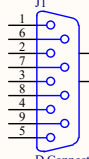

Generic D-Sub 9 Cable M-F

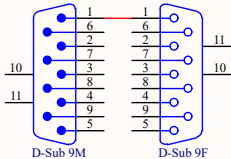

Generic D-Sub 9 Cable M-F

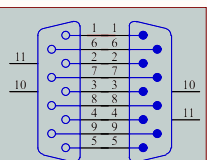

Generic D-Sub 9 Cable M-F

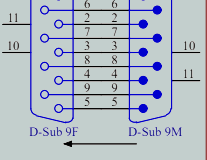

Generic D-Sub 9 Cable M-F

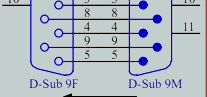

## Low Power Coil Driver #0

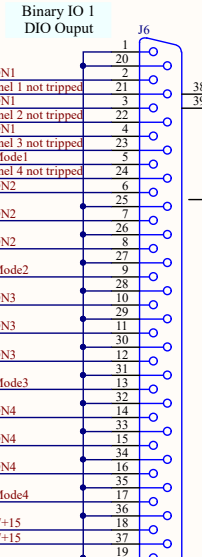
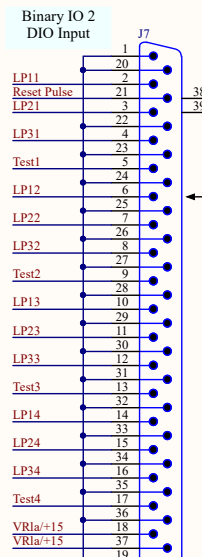
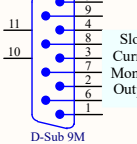
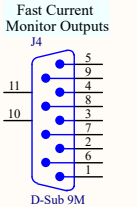
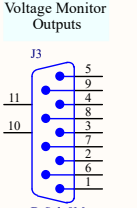
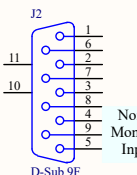
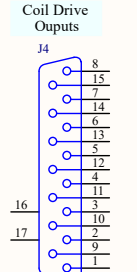
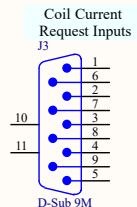

Chassis: JGW-D1503506,  
Front Panel: JGW-D1503508,  
Main Board: JGW-D1503507  
BIO Board: JGW-D1504332

Cable F-M and Gender Bender F-F 37 pin

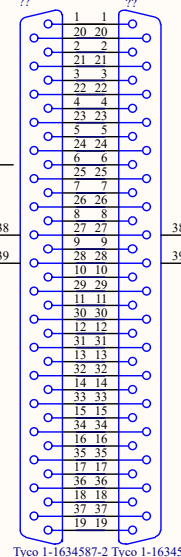

Cable M-F 37 pin

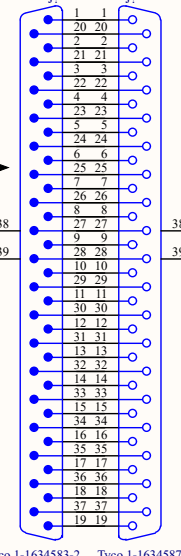

## DIO Card #0

Contec DIO-6464L-PE

Cannot open file  
C:\Users\Enzo  
Nicolas\Dropbox\TypeB\Ele  
ctronics\BS Suspension  
Cabling  
(JGW-D1503600)JGW-D1  
503600 BS Suspension  
Cabling\DI06464L-PE.mbr

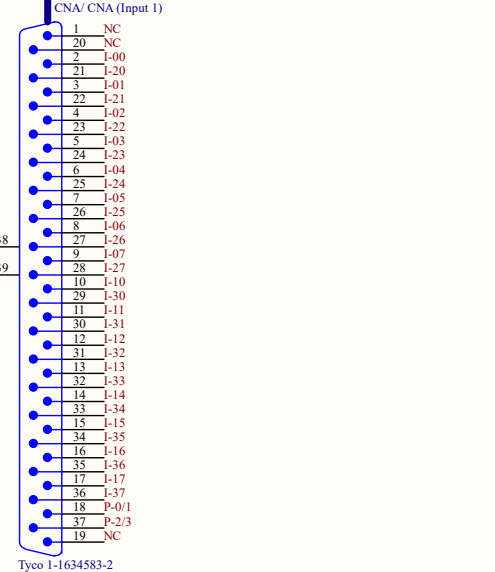
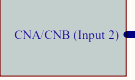
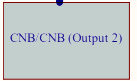
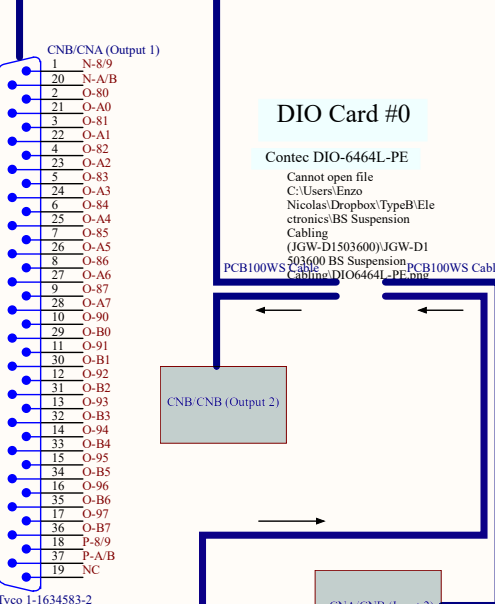

Title		
BS Suspension Cabling - OSEM Sat Amps & Drivers - TM		
Size	Number	Revision
A3	JGW-D1503600	-v13
Date:	2017/04/27	Sheet 9 of 18
File:	\\.\09 Sat Amps & Coil Drivers OP.Sch\JobDrawn By:	

# OSEM Sat Amp and Driver - IM 1

## Sat Amp #1

Chassis: JGW-D1503498,  
Front Panel: JGW-D1503500,  
Rear Panel: JGW-D1503500,  
Board: JGW-D1503499

Inputs from IM OSEMs  
V1, V2, V3, H1  
(see Sheet 2)

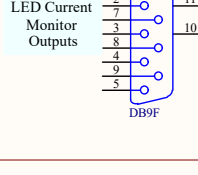
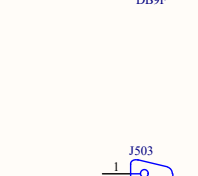
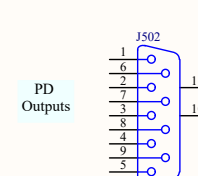
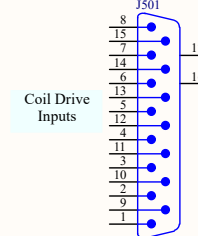
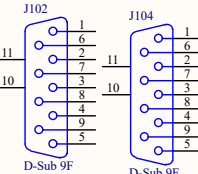
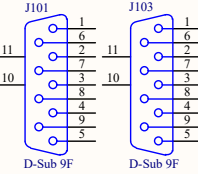

## AI Chassis #0 D1100650

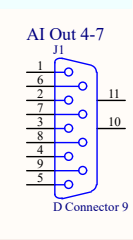

## Generic D-Sub 9 Cable M-F

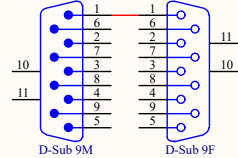

## Generic D-Sub 15 Cable M-F

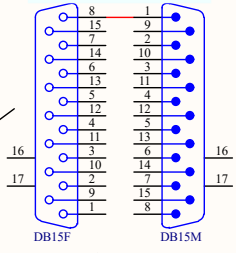

## AA Chassis #1 D1100621

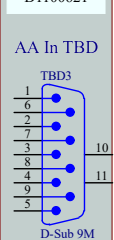

## AA Chassis #0 D1100621

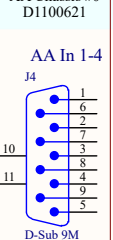

## AA In TBD TBD1

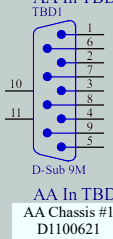

## AA In TBD TBD2

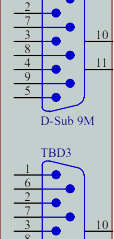

## AA In TBD TBD3

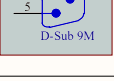

## Low Power Coil Driver #1

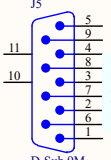
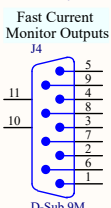
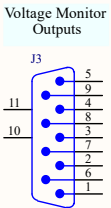
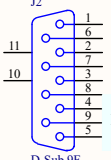
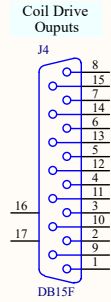
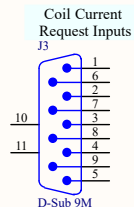

## Binary IO 2 DIO Input

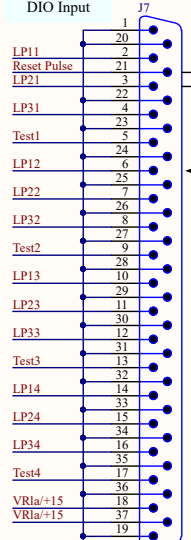

## Binary IO 1 DIO Output

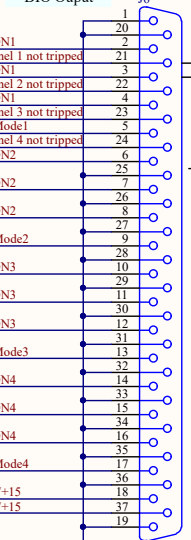

## Cable F-M and Gender Bender F-F 37 pin

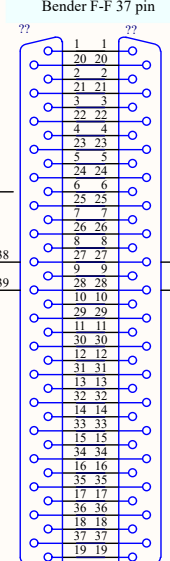

## Cable M-F 37 pin

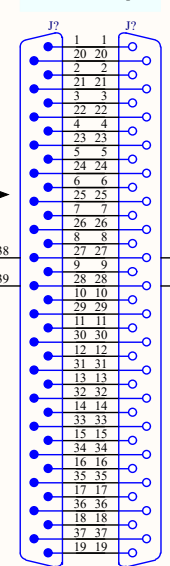

## DIO Card #0

Contec DIO-6464L-PE

Cannot open file  
C:\Users\Enzo  
Nicolas\Dropbox\TypeB\Ele  
ctronics\BS Suspension  
Cabling  
(JGW-D1503600)JGW-D1  
503600 BS Suspension  
Cabling\DI06464L-PE.mbr

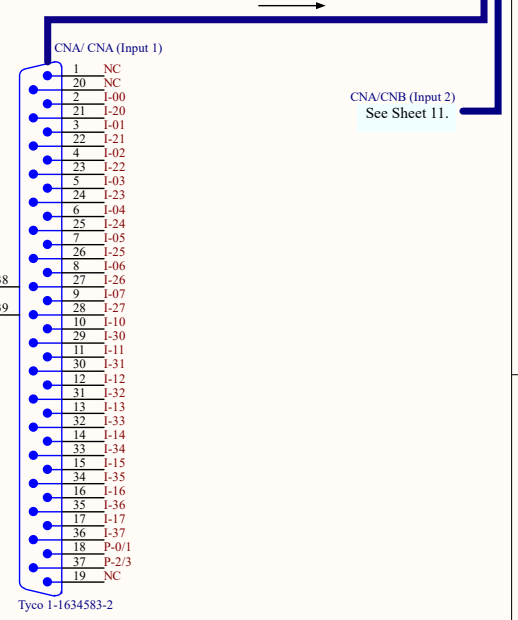
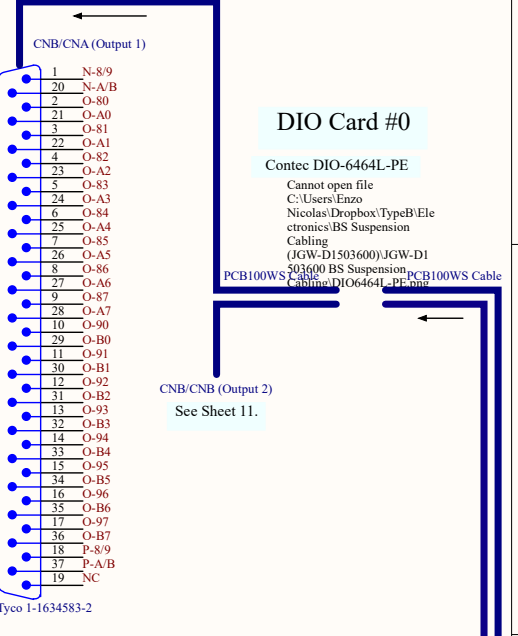

Chassis: JGW-D1503506,  
Front Panel: JGW-D1503508,  
Main Board: JGW-D1503507  
BIO Board: JGW-D1504332

Title BS Suspension Cabling - OSEM Sat Amps & Drivers - IM 1		
Size A3	Number JGW-D1503600	Revision -v13
Date: 2017/04/27	Sheet 1 of 18	
File: \\.\10 Sat Amps & Coil Drivers IM 1.Sch	Drawn By:	

# OSEM Sat Amp and Driver - IM 2

## Sat Amp #1

Chassis: JGW-D1503498,  
Front Panel: JGW-D1503500,  
Rear Panel: JGW-D1503500,  
Board: JGW-D1503499

Inputs from IM  
OSEMs H2, H3  
(see Sheet 2)

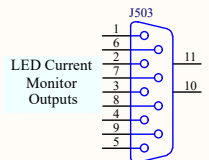
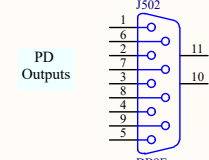
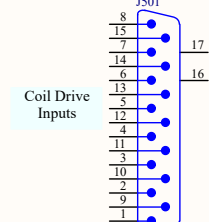
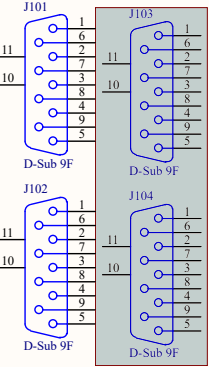

## AI Chassis #0 D1100650

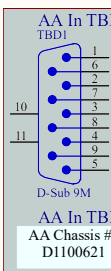
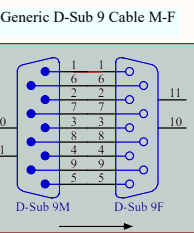
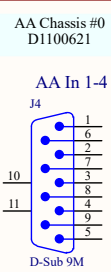
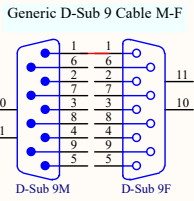
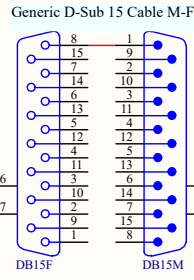
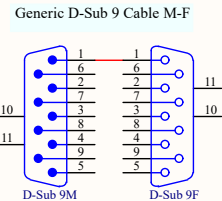
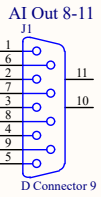

## AA Chassis #1 D1100621

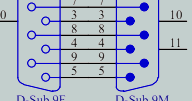
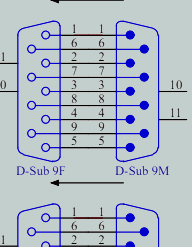
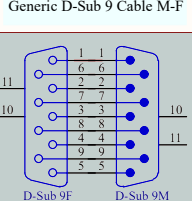
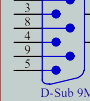
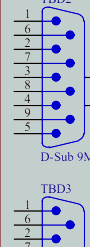
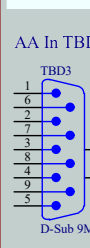

## Low Power Coil Driver #2

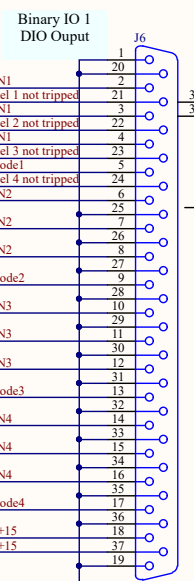
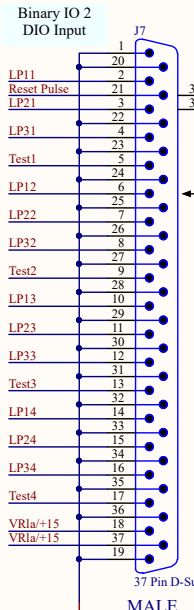
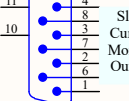
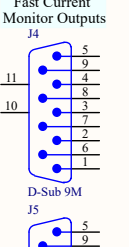
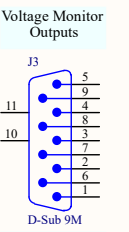
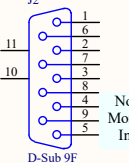
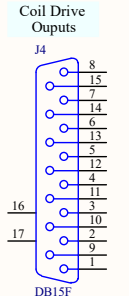
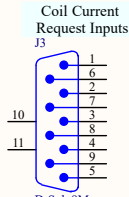

Chassis: JGW-D1503506,  
Front Panel: JGW-D1503508,  
Main Board: JGW-D1503507  
BIO Board: JGW-D1504332

## Cable F-M and Gender Bender F-F 37 pin

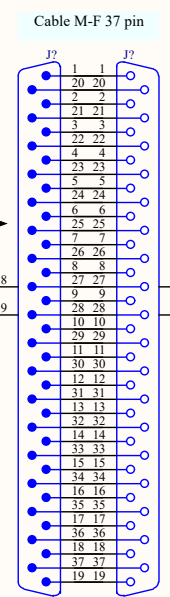
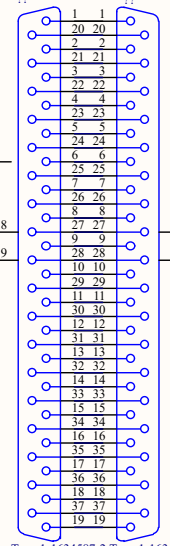

## CNA/CNB (Output 2)

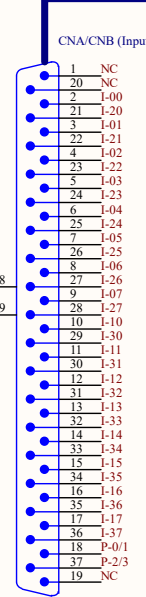
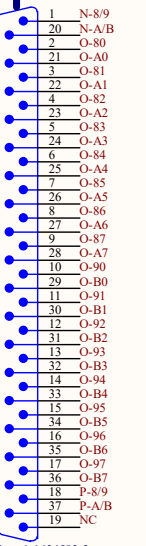

## DIO Card #1

Contec DIO-6464L-PE

See also Sheet 10.

See Sheet 10.

Cannot open file  
C:\Users\Enzo  
Nicolas\Dropbox\TypeB\Ele  
ctronics\BS Suspension  
See also Sheet 10.  
C:\Users\Enzo  
Nicolas\Dropbox>TypeB\Ele  
ctronics\BS Suspension  
PCB100WS\503600\JGW-D1503499\PCB100WS Cable  
305600 BS Suspension  
Cable\DI06464L-PE.png

See Sheet 10.

CNA/ CNA (Input 1)

Title		
BS Suspension Cabling - OSEM Sat Amps & Drivers - IM 2		
Size	Number	Revision
A3	JGW-D1503600	-v13
Date:	2017/04/27	Sheet1 of 18
File:	\\.\11 Sat Amps & Coil Drivers IM 2.Sch1 Down By:	



# BS&F1 LVDT Drivers

**Inputs from BS&F1 LVDTs**  
(see Sheet 5)

LVDT/ACT Distributor - see also Sheet 13  
Chassis: JGW-D1402124  
Front Panel: JGW-D1402827  
Rear Panel: JGW-D1402828  
Board: JGW-D1402117

Ch 0-3 LVDT-IN

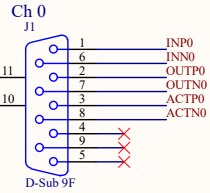
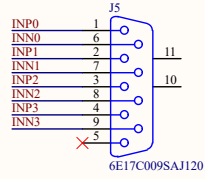

Ch 0-3 LVDT-OUT

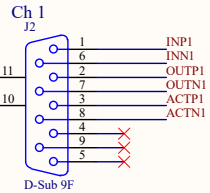
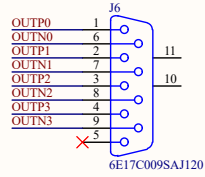

Ch 0-3 ACT

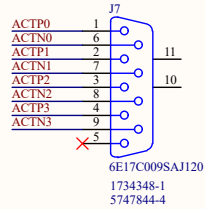

2 inputs unused

Ch 2  
Ch 3

Generic D-Sub 9 Cable M-F

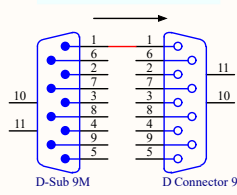

Generic D-Sub 9 Cable M-F

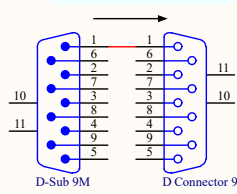

LVDT Driver - see also Sheet 13  
Chassis: JGW-D1402826,  
Main Board: JGW-D1301467  
Input Boards (2): JGW-D1301467  
Front Panel: JGW-D1402827

LVDT CARD 1 (Left)

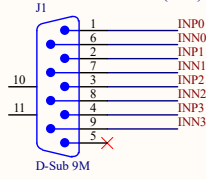

LVDT MAIN (Left)

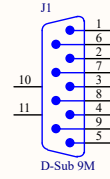

LVDT CARD 1 (Right)

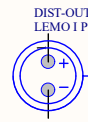
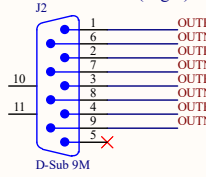

Gender Bender F-F

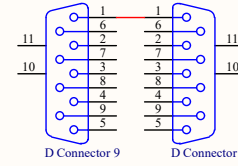

Generic D-Sub 9 Cable M-F

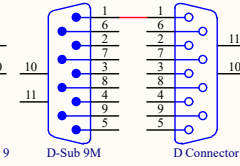

AA Chassis #1  
JGW-D1100621

AA In 12-15

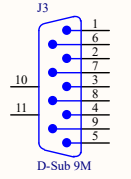

The LVDT Chassis has provision for an oscillator card, but until such time as the cards are available, an external oscillator will be required

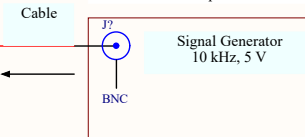

See connections in sheet 13.

Title BS Suspension Cabling - BS&F1 LVDT Drivers		
Size A3	Number JGW-D1503600	Revision -v13
Date: 2017/04/27	Sheet 12	of 18
File: \\...12 BS&F1 LVDT Drive.SchDoc	Sheet 12	of 18
Date: 2017/04/27		Sheet 12
File: \\...12 BS&F1 LVDT Drive.SchDoc		Sheet 12
Date: 2017/04/27		Sheet 12
File: \\...12 BS&F1 LVDT Drive.SchDoc		Sheet 12

# BS&F1 LVDT Drivers Part 2

**Inputs from BS&F1 LVDTs**  
(see Sheet 5)

LVDT/ACT Distributor - see also Sheet 13  
Chassis: JGW-D1402124  
Front Panel: JGW-D1402827  
Rear Panel: JGW-D1402828  
Board: JGW-D1402117

**Ch 0-3 LVDT-IN**

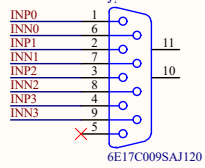

See connections in sheet 12.

**Ch 0**

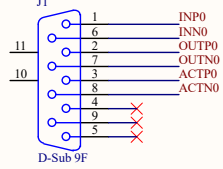

**Ch 1**

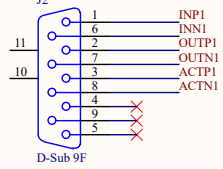

2 inputs unused  
Ch 2  
Ch 3

**Ch 0-3 LVDT-OUT**

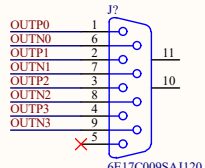

See connections in sheet 12.

**Ch 0-3 ACT**

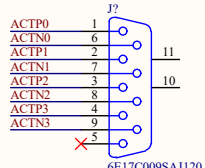

**AI Chassis #1**  
D1101521

**AI Out 1-4**

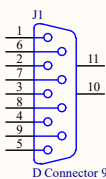

## High Power Coil Driver #0

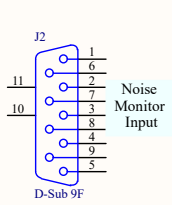

Noise Monitor Input

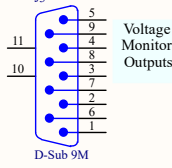

Voltage Monitor Outputs

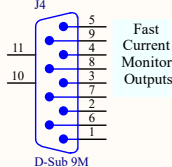

Fast Current Monitor Outputs

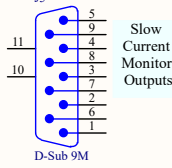

Slow Current Monitor Outputs

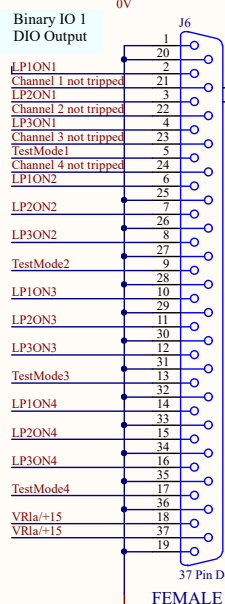
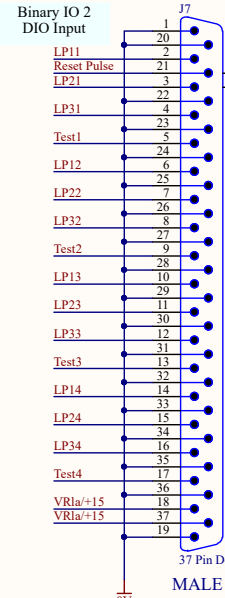
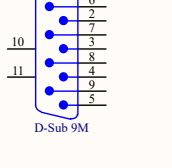
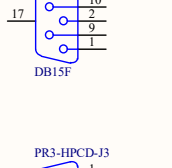
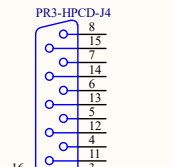

**High Power Coil Driver #2**  
Chassis: JGW-D1503504  
Front Panel: JGW-D1503502  
Rear Panel: JGW-D1503505,  
Monitor Board: JGW-D1503510  
Coil Driver Interface Board: JGW-D1504332  
Main Board: JGW-D1503503

**Cable F-M and Gender Bender F-F 37 pin**

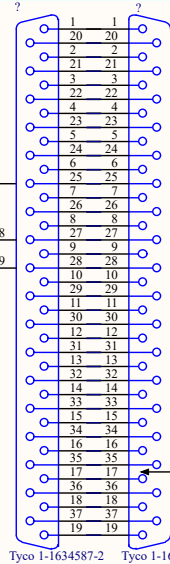

**Cable M-F 37 pin**

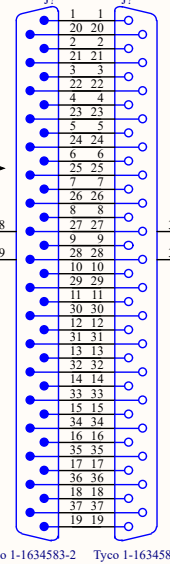

**CNB/CNA (Output 1)**

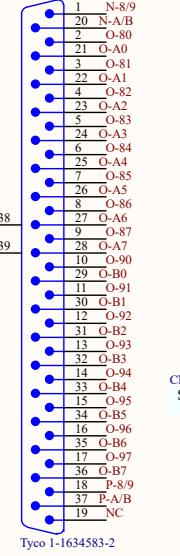

**CNB/CNB (Output 2)**



**CNA/CNA (Input 1)**



## DIO Card #2

Contec DIO-6464L-PE  
Cannot open file  
C:\Users\Enzo  
Nicolas\Dropbox\TypeB\Ele  
ctronics\BS Suspension  
Cabling  
JGW-D1503600\JGW-D1  
503600 BS Suspension  
Cabling\PCB100W Cable  
DIO6464L-PE

**CNA/CNB (Input 2)**



Title BS Suspension Cabling - BS&F1 LVDT Drivers		
Size A3	Number JGW-D1503600_13	Revision -v13
Date: 2017/04/27	Sheet of 18	Drawn By:
File: \\.\13 BS&F1 LVDT Drive.SchDoc		

**Inputs from F0  
LVDTs  
(see Sheet 6)**

(LVDT/ACT Distributor - see Sheet 12)  
Chassis: JGW-D1402124,  
Front Panel: JGW-D1402827  
Rear Panel: JGW-D1402828,  
Board: JGW-D1402117 #1

Front Panel

Rear Panel

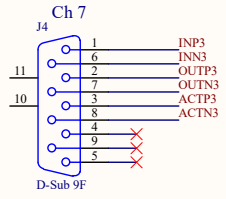
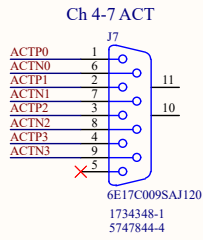
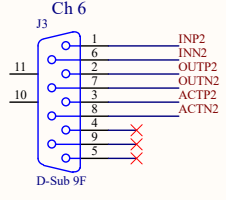
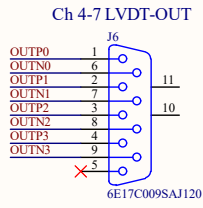
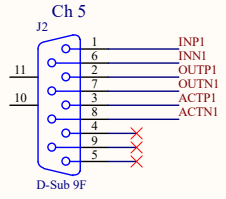
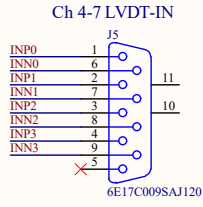
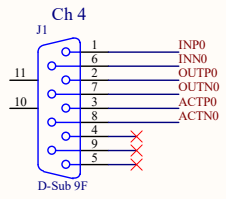

**F0 LVDT Drivers**

(LVDT Driver - see Sheet 12)  
Chassis: JGW-D1402826,  
Main Board: JGW-D1301467  
Input Boards (2): JGW-D1301467  
Front Panel: JGW-D1402827

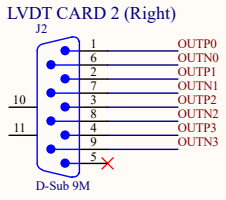
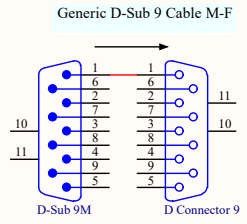
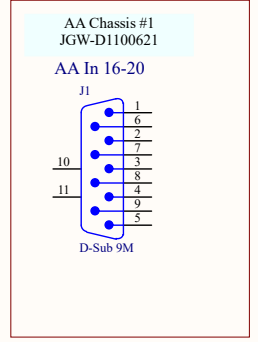
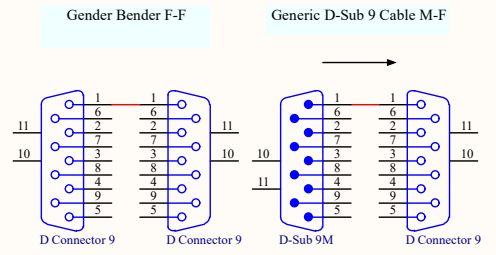
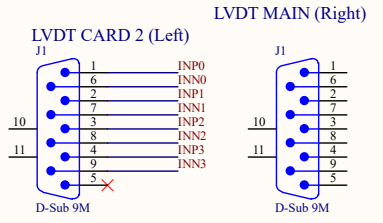
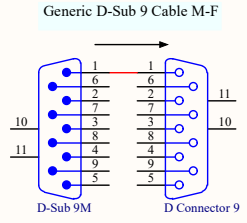

See connections in sheet 15

Title		
BS Suspension Cabling - F0 LVDT Drivers		
Size	Number	Revision
A3	JGW-D1503600	-v13
Date:	2017/04/27	Sheet of 18
File:	\\.\14 F0 LVDT Drive.SchDoc	Drawn By:

**Inputs from F0 LVDTs (see Sheet 6)**

(LVDT/ACT Distributor - see Sheet 12)  
 Chassis: JGW-D1402124,  
 Front Panel: JGW-D1402827  
 Rear Panel: JGW-D1402828,  
 Board: JGW-D1402117 #1

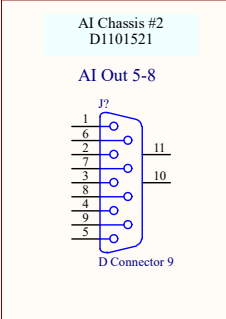
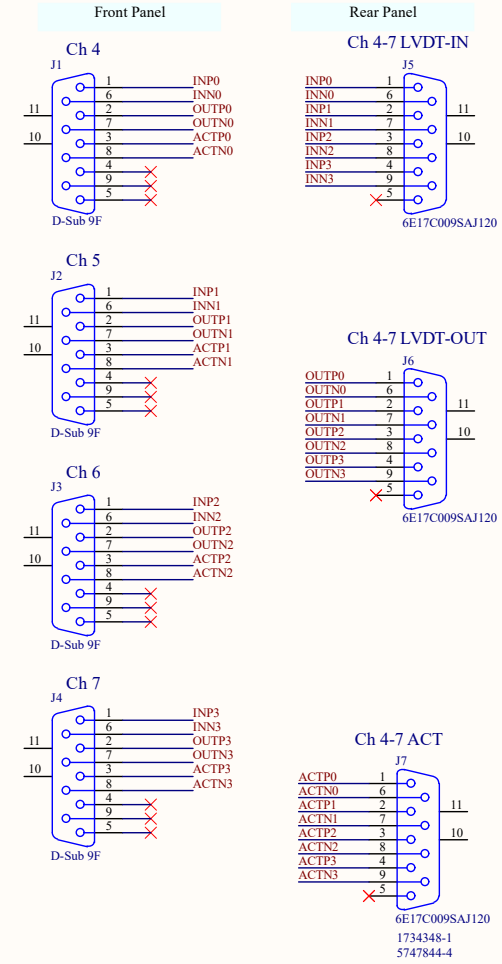

**F0 LVDT Drivers Part 2**

**High Power Coil Driver #1**

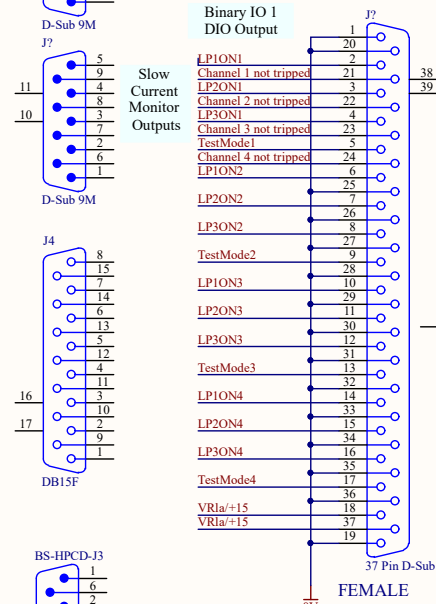
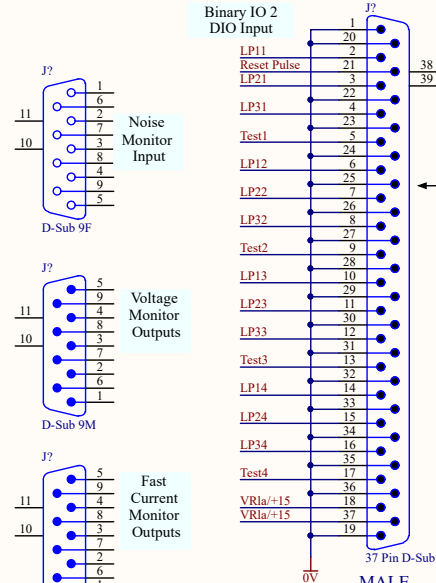

**High Power Coil Driver #2**  
 Chassis: JGW-D1503504  
 Front Panel: JGW-D1503502  
 Rear Panel: JGW-D1503505,  
 Monitor Board: JGW-D1503510  
 Coil Driver Interface Board: JGW-D1504332  
 Main Board: JGW-D1503503

**Cable F-M and Gender Bender F-F 37 pin**

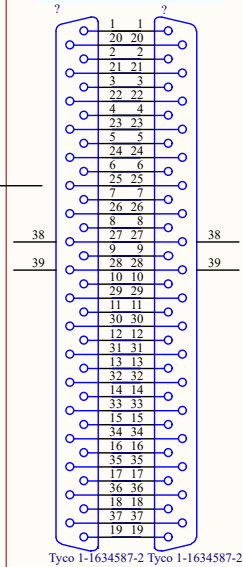

**Cable M-F 37 pin**

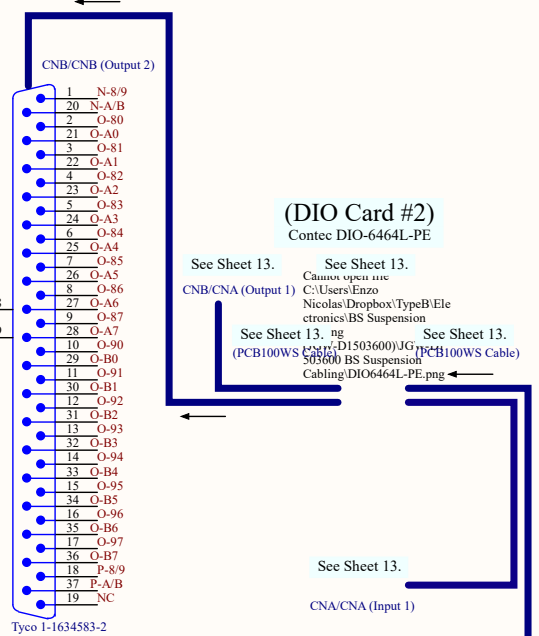
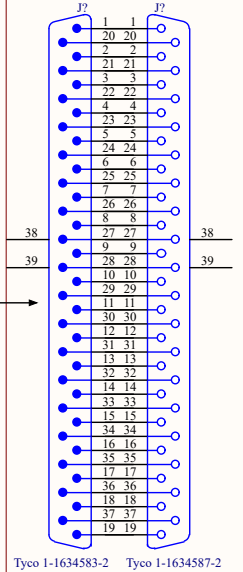

**(DIO Card #2)**  
 Contec DIO-6464L-PE

See Sheet 13. See Sheet 13.  
 C:\Users\Enzo\nicolas\Dropbox\TypeB\Electronics\BS Suspension  
 C:\Users\Enzo\nicolas\Dropbox\TypeB\Electronics\BS Suspension  
 See Sheet 13. See Sheet 13.  
 (PCB100WS Cable) (PCB100WS Cable)

See Sheet 13.

See connections in sheet 14.

See connections in sheet 14.

**LVDT-Coil Driver Cable**

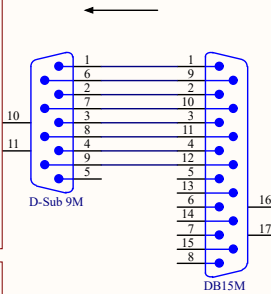

**Generic D-Sub 9 Cable M-F**

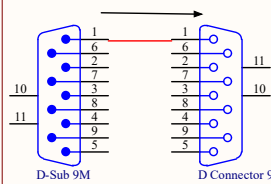

Title			BS Suspension Cabling - F0 LVDT Drivers		
Size	Number			Revision	
A3	JGW-D1503600	15			-v13
Date:	2017/04/27	Sheet of		18	
File:	\\.\15 F0 LVDT Drive.SchDoc	Drawn By:			

# Pico and Stepper Drivers

Outputs to IM Picos (see Sheet 3)

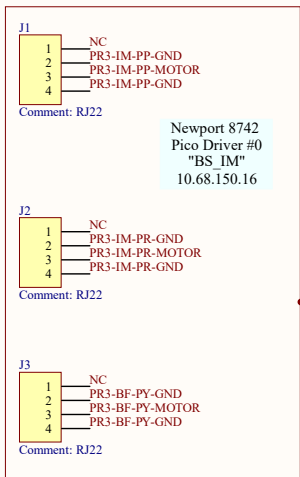

AC

The connectors for the pico drivers are RJ22 with four pins. I couldn't find Altium versions, so I used a random four-pin connector.

Outputs to BF Picos (see Sheet 4)

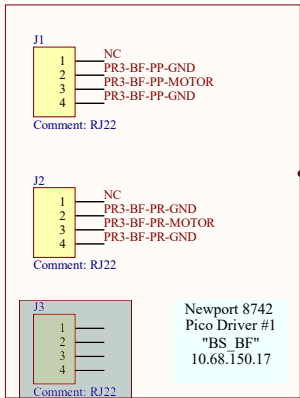

AC

Output to BF Stepper (see Sheet 4)

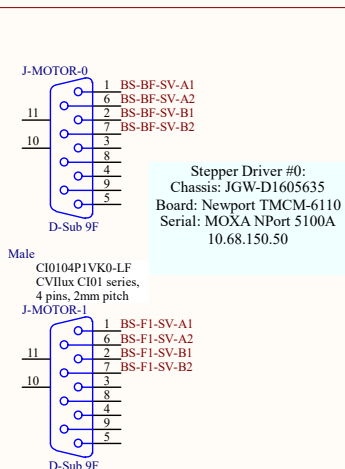

Output to F1 Stepper (see Sheet 4)

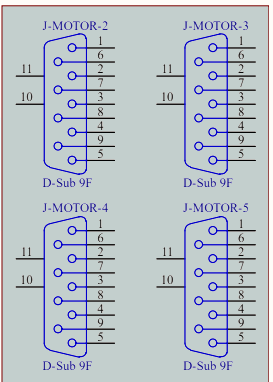

Stepper Driver #1  
Chassis: JGW-D1605365  
Board: TMCM-6110  
Serial: MOXA NPort 5100A  
10.68.150.51

NOTE: 3 channels use switches

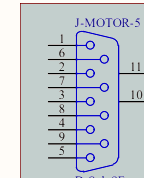
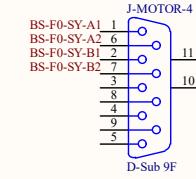
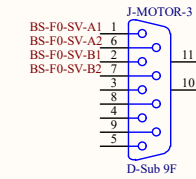
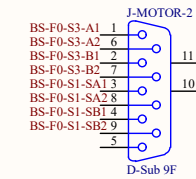
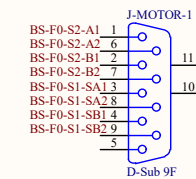
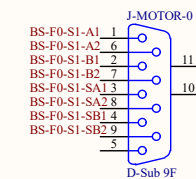

Outputs to F0 Steppers (see Sheet 7)

Ethernet Hub

PoE

Title			
BS Suspension Cabling - Pico and Stepper Drivers			
Size	Number	Revision	
A3	JGW-D1503600	16	-v13
Date:	2017/04/27	Sheet of	18
File:	\\.\16 Pico&Stepper Drive.SchDoc	Drawn By:	

3 Feedthroughs

### Geophone Readout

#### Inputs from F0 Geophones (see Sheet 8)

Geophone Distributor  
D1402120  
Front Panel  
D1402122  
Board  
D1402121

Geophone Distributor  
D1402120  
Rear Panel  
D1402123  
Board  
D1402121

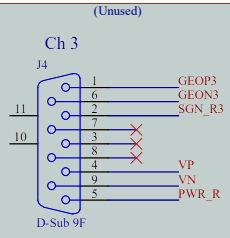
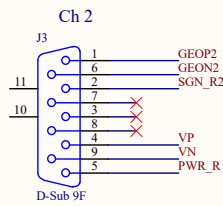
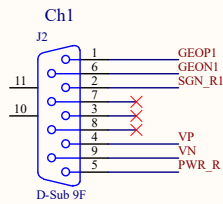
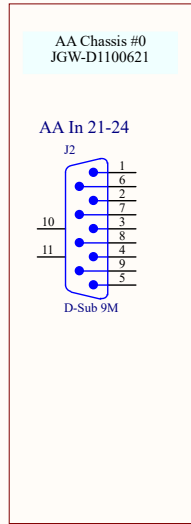
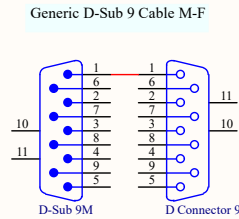
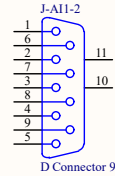
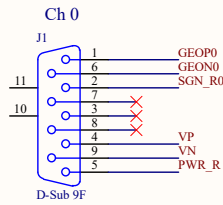

Title			BS Suspension Cabling - Geophone Readout		
Size	Number	Revision			
A3	JGW-D1503600	17	-v13		
Date:	2017/04/27	Sheet	of	18	
File:	\\.\17 Geophone Readout.SchDoc	Drawn By:			

# OpLev Etc

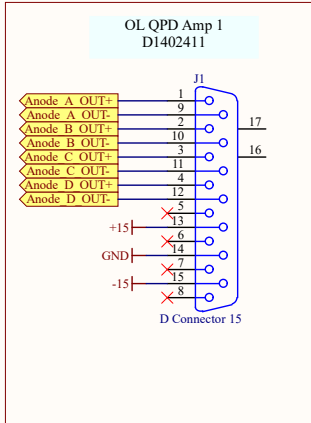

Generic D-Sub 15 Cable M-F

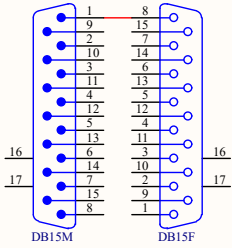

Generic D-Sub 15 Cable M-F

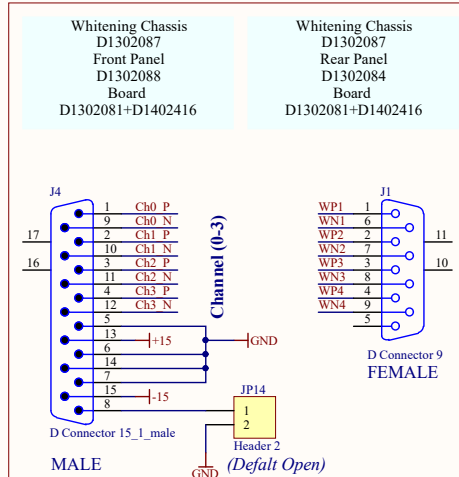
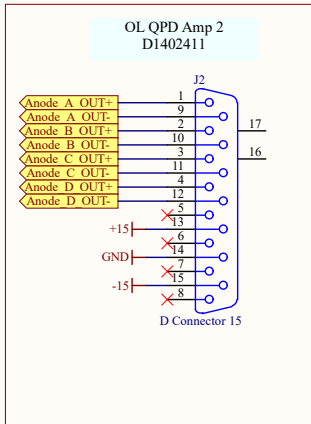
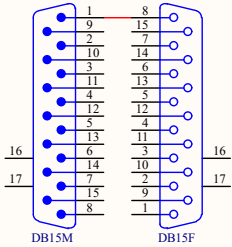

Generic D-Sub 9 Cable M-F

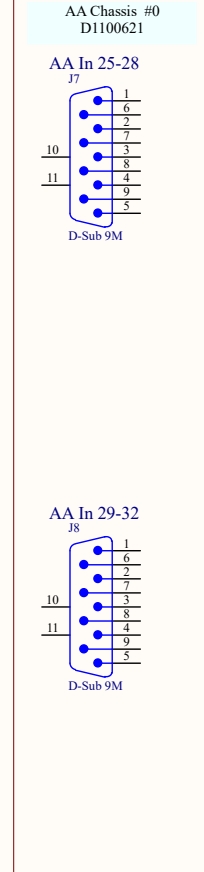
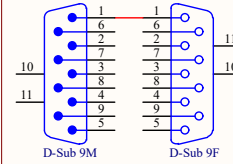

Generic D-Sub 9 Cable M-F

