

4 Feedthroughs

TM OSEMs

Incorporates flip to correct flexicircuit issue!!!

OSEM

TM OSEM to BF Cable

BF to F0 Signal Cable

PI-Flange Signal Cable

Feedthrough

Anti-Feedthrough Adapter Cable

OSEM External Cable

Sat Amp #0

Glenair GMR7590-9P-1BPN

Glenair MWDMD2L-9S

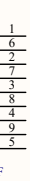
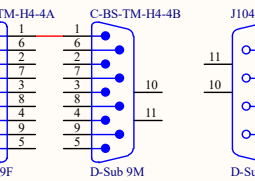
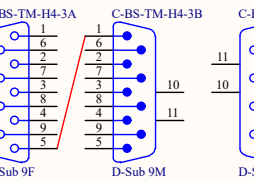
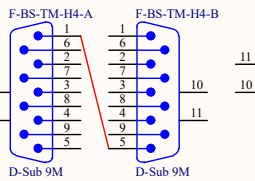
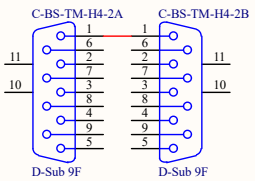
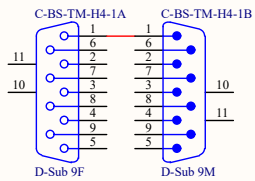
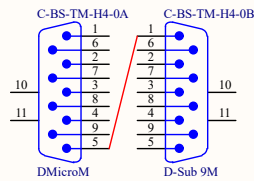
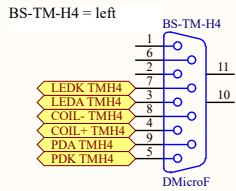
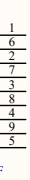
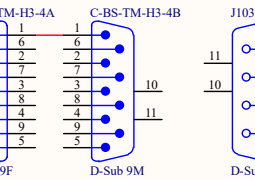
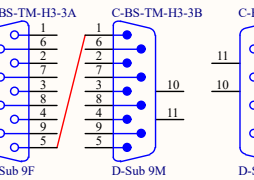
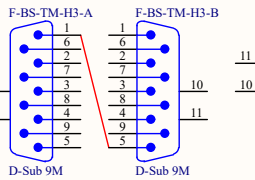
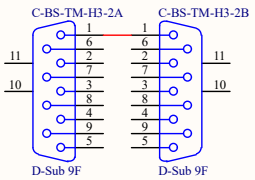
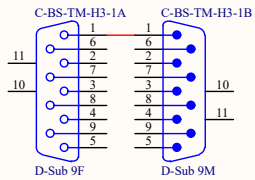
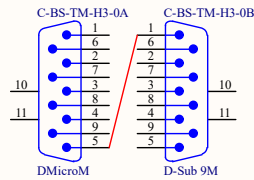
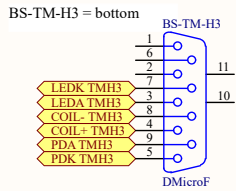
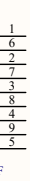
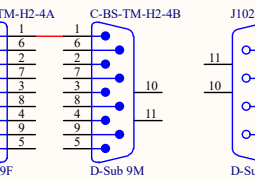
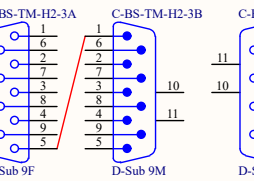
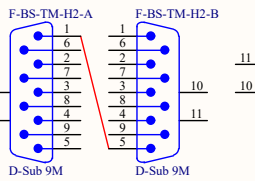
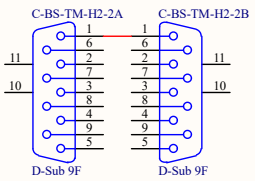
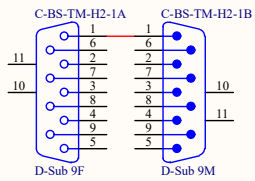
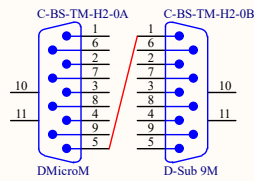
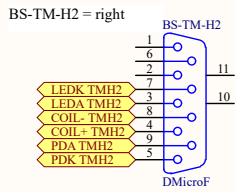
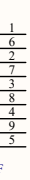
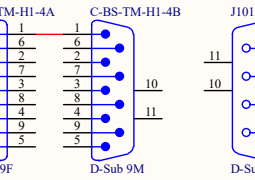
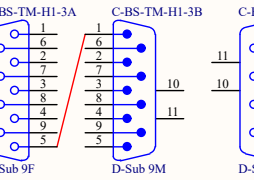
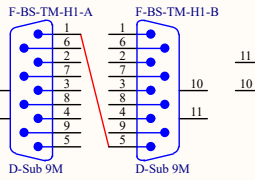
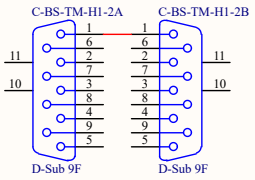
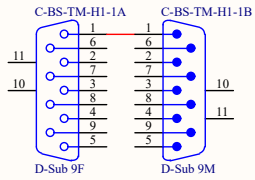
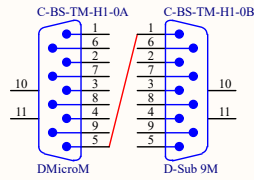
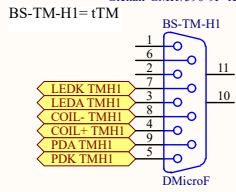

Title		
BS Suspension Cabling - Test Mass OSEMs		
Size	Number	Revision
A3	JGW-D1503600	-v12
Date:	2017/01/30	Sheet of 16
File:	\\..01.TM OSEMs.SchDoc	Drawn By:

6 Feedthroughs

IM OSEMs

Incorporates flip to correct flexicircuit issue!!!

IM OSEM to BF Cable
JGW-D1503901 Sheet 02

BF to F0 Signal Cable
JGW-D1503901 Sheet 08

PI-Flange Signal Cable
JGW-D1503901 Sheet 11

Feedthrough

Anti-Feedthrough Adapter Cable

OSEM External Cable

Sat Amp #1
D1402809

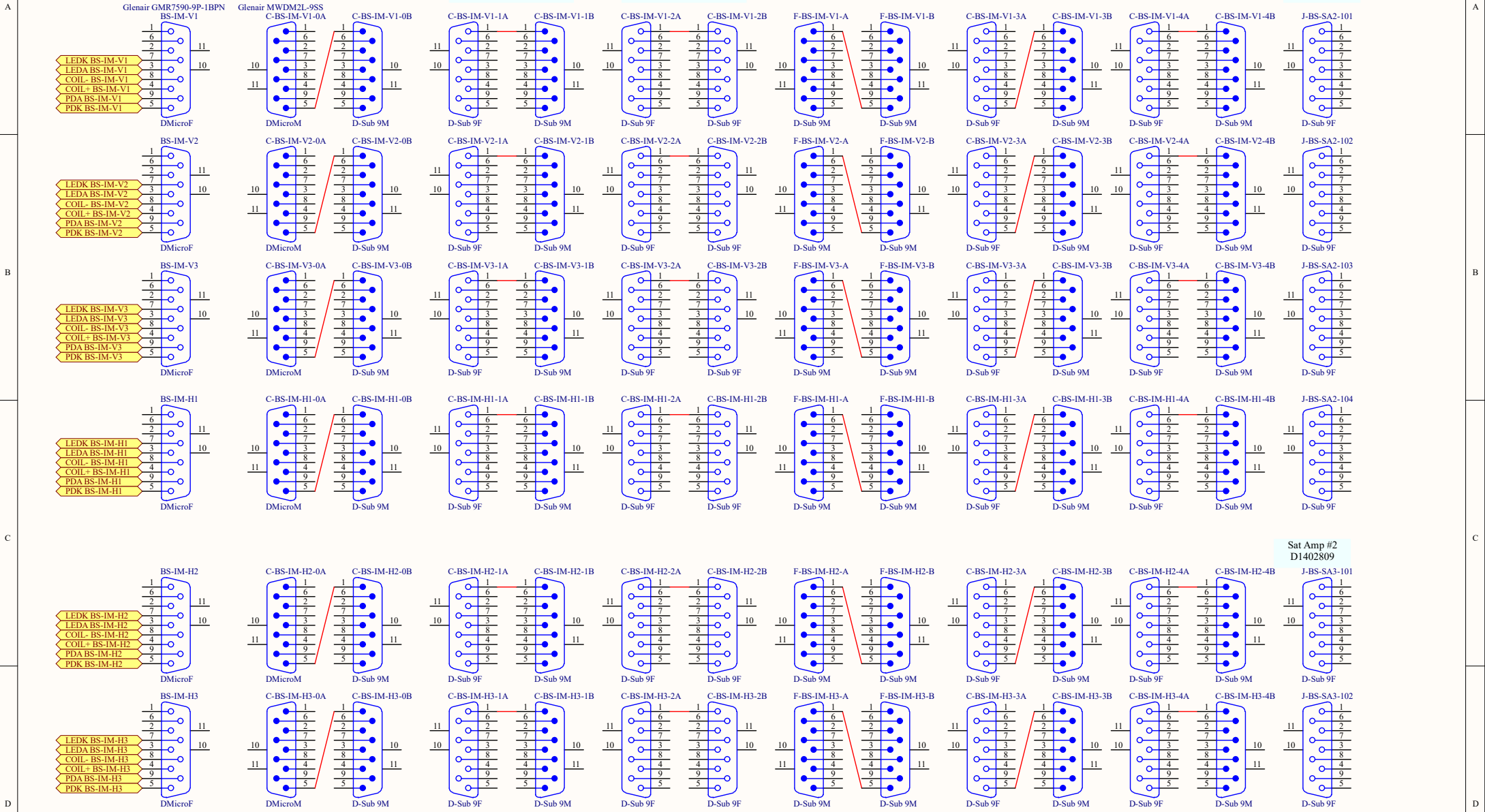

J-BS-SA3-103 and J-BS-SA3-104 not used

Title BS Suspension Cabling - Intermediate Mass OSEMs		
Size A3	Number JGW-D1503600	Revision -v12
Date: 2017/01/30	Sheet 7 of 16	
File: \\..02 IM OSEMs.SchDoc	Drawn By:	

1 Feedthrough

IM Picomotors & BF Yaw Picomotor

In -v10, the BS Yaw Pico was moved to the IM sheet and grouped with the IM picos, because it's more physically convenient for wiring and more logical (it actually rotates the IM).

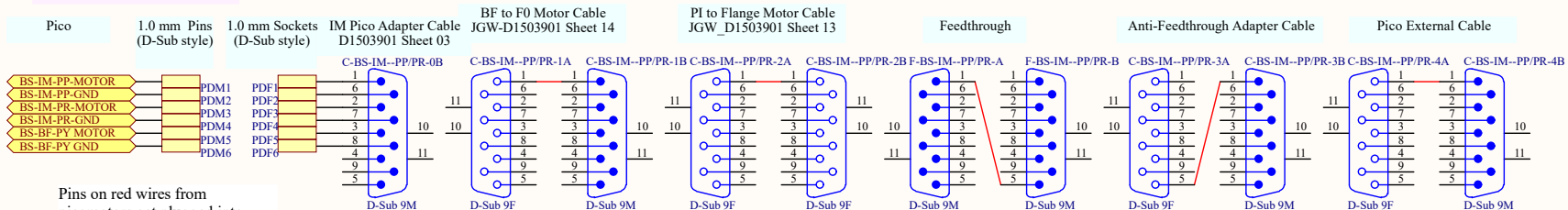

Pins on red wires from picomotors get plugged into sockets from pins 1, 2, 3.

Pins on white wires from picomotors get plugged into sockets from pins 6, 7, 8.

The pico motor at the bottom level of the IM does pitch and gets plugged into 1&6.

The pico motor at the top level of the IM does roll and gets plugged into 2&7.

The pico motor in the BS does IM yaw and gets plugged into 3&8.

The connectors for the pico drivers are RJ22 with four pins. I couldn't find Altium versions, so I used a random four-pin connector.

The adapter cable is made by combining the cables supplied by the pico manufacturer (Newport) with a D-Sub 9 female.

Green wires from manufacturer's cables get soldered to pins 1, 2.

Yellow wires from manufacturer's cables get soldered to pins 6, 7.

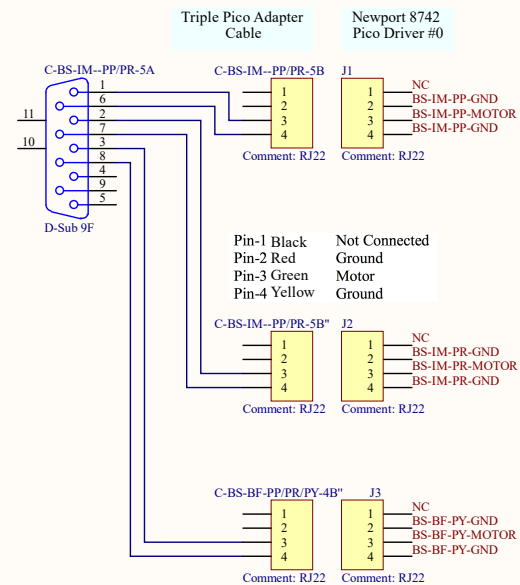

Title BS Suspension Cabling - IM Picos and BF Yaw Pico			
Size A3	Number JGW-D1503600	Revision -v12	
Date: 2017/01/30	Sheet 3 of 16		
File: \\.\03 IM Picos & BF Yaw Pico.SchDoc	Drawn By:		

3 Feedthroughs

In -v10, the BS Yaw Pico was moved to the IM sheet and grouped with the IM picos, because it's more physically convenient for wiring and more logical (it actually rotates the IM).

BF and F1 Picomotors and Steppers

The connectors for the pico drivers are RJ22 with four pins. I couldn't find Altium versions, so I used a random four-pin connector.

Pin-1 Black Not Connected
Pin-2 Red Ground
Pin-3 Green Motor
Pin-4 Yellow Ground

Picos 1.0 mm Pins (D-Sub style) 1.0 mm Sockets (D-Sub style) BF Pico Adapter Cable D1503901 Sheet 04

BF to F0 Motor Cable JGW-D1503901 Sheet 14

PI to Flange Motor Cable JGW-D1503901 Sheet 13

Feedthrough

Anti-Feedthrough Adapter Cable

Pico External Cable

Pico Adapter Cable

Newport 8742 Pico Driver #1

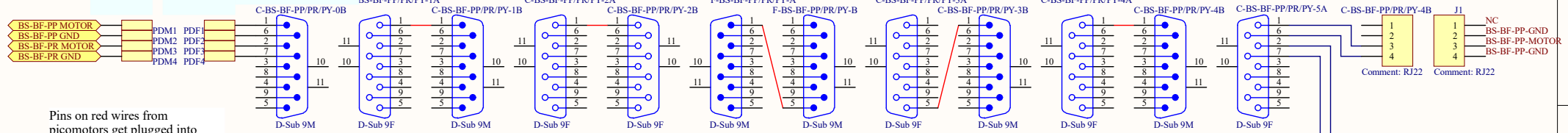

Pins on red wires from picomotors get plugged into sockets from pins 1, 2.

Pins on white wires from picomotors get plugged into sockets from pins 6, 7.

The adapter cable is made by combining the cables supplied by the pico manufacturer (Newport) with a D-Sub 9 female.

Green wires from manufacturer's cables get soldered to pins 1, 2, 3.

Yellow wires from manufacturer's cables get soldered to pins 6, 7, 8.

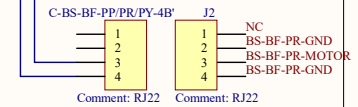

Steppers 1.6 mm Sockets (Burndy) 1.6 mm Pins (Burndy) BF&F1 Stepper Adapter Cable D1503901 Sheet 05

BF to F0 Motor Cable JGW-D1503901 Sheet 14

PI to Flange Motor Cable JGW_D1503901 Sheet 13

Feedthrough

Anti-Feedthrough Adapter Cable

Stepper External Cable

Stepper Driver #0
Chassis: JGW-D1605365
Board: TCMCM-6110
Serial-Internet Converter: MOXA NPort 5100A

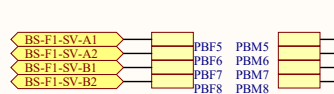
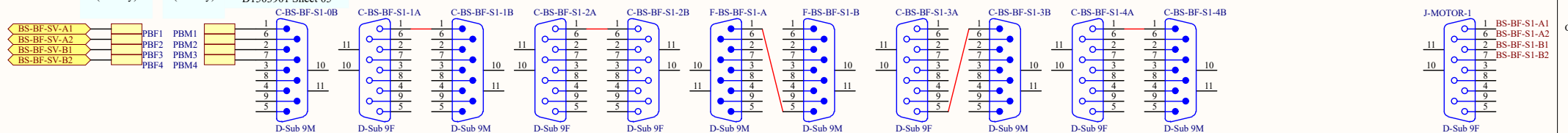

	Colour
Phase A+	Green
Phase A-	Grey
Phase B+	Black
Phase B-	White
Thermocouple +	Brown
Thermocouple -	Blue

Title BS Suspension Cabling - Bottom and Standard Filter Picos/Steppers			
Size A3	Number JGW-D1503600	Revision -v12	
Date:	2017/01/30	Sheet 4 of 16	
File:	\\.\04 BF&F1 Picos&Steppers.SchDoc	Drawn By:	

GAS (BF, F1 and F0) LVDT/ACTs

2 Feedthroughs

LVDT/ACT Distributor - see also Sheet 12
 Chassis: JGW-D1402124
 Front Panel: JGW-D1402827
 Rear Panel: JGW-D1402828
 Board: JGW-D1402117

LVDT/Act

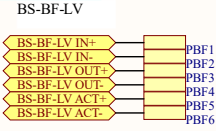

BF&F1 LVDT Adapter Cable
JGW-D1503901 Sheet 06

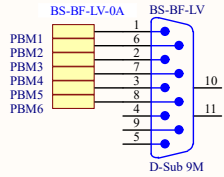

BF-F0 Signal Cable
JGW-D1503901 Sheet 08

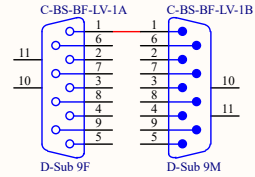

PI-Flange Signal Cable
JGW_D1503901 Sheet 11

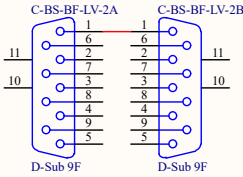

Feedthrough

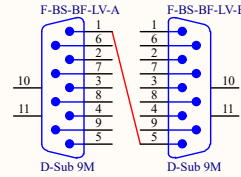

Feedthrough Adapter Cable

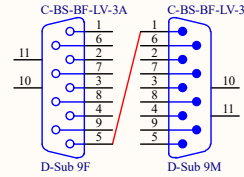

External Cable

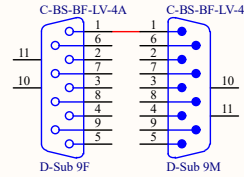

Ch 0

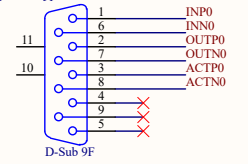

LVDT/Act

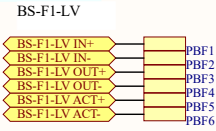

BF&F1 LVDT Adapter Cable
JGW-D1503901 Sheet 06

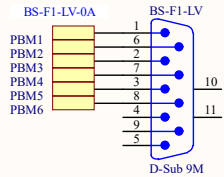

BF-F0 Signal Cable
JGW-D1503901 Sheet 08

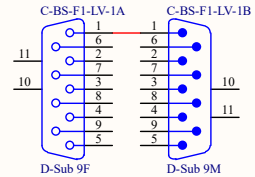

PI-Flange Signal Cable
JGW_D1503901 Sheet 13

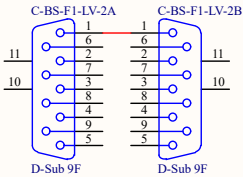

Feedthrough

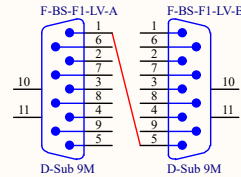

Feedthrough Adapter Cable

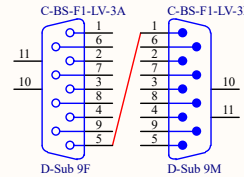

External Cable

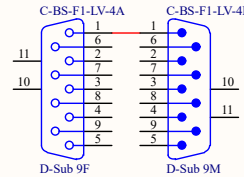

Ch 1

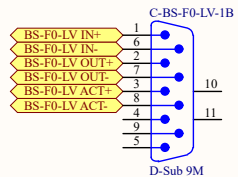
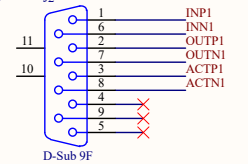

OPTIONAL
Signal Cable Extension
JGW_D1503901 Sheet 10

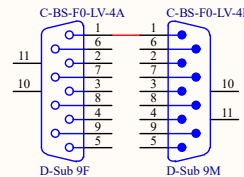
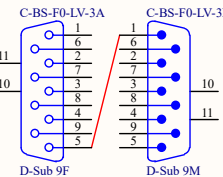
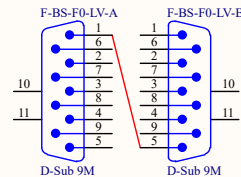
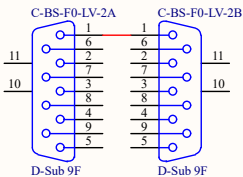

(Unused)

Ch 2

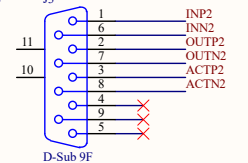

Ch 3

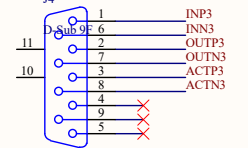

Title			BS Suspension Cabling - GAS LVDTs		
Size	Number	Revision			
A3	JGW-D1503600	-v12			
Date:	2017/01/30	Sheet	5of	16	
File:	\\.\05 GAS LVDTs.SchDoc	Drawn By:			

4 Feedthroughs

Preisolator LVDT/ACTs

LVDT/ACT Distributor - see also Sheet 13
 Chassis: JGW-D1402124
 Front Panel: JGW-D1402827
 Rear Panel: JGW-D1402828
 Board: JGW-D1402117

LVDT/ACT

OPTIONAL
 Signal Cable Extension
 JGW_D1503901 Sheet 10

PI-Flange Signal Cable
 JGW_D1503901 Sheet 11

Feedthrough

Anti-Feedthrough Adapter Cable

LVDT/ACT External Cable

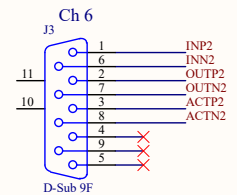
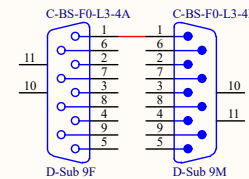
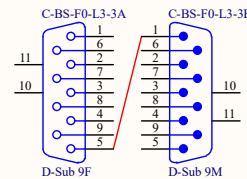
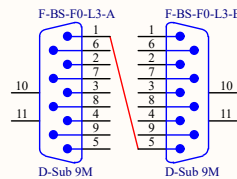
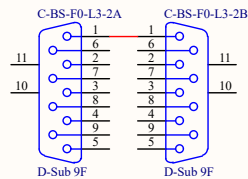
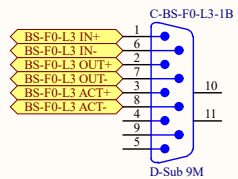
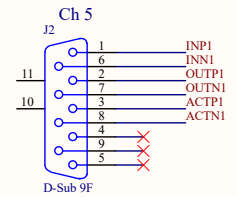
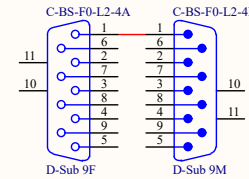
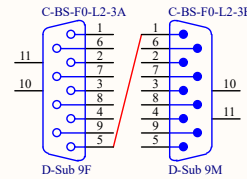
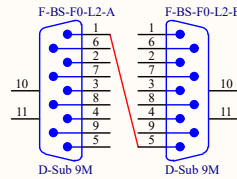
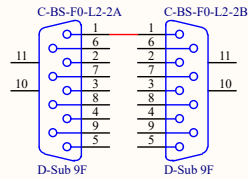
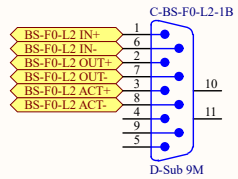
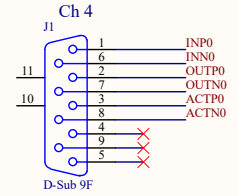
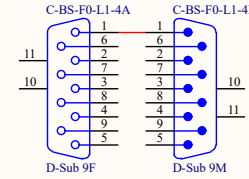
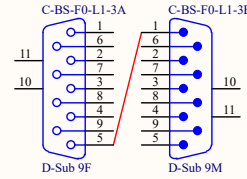
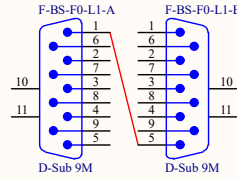
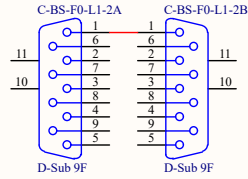
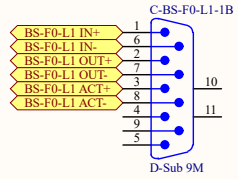

LVDT-COIL

Pin	Function
1	LVDT IN P
2	LVDT OUT P
3	COIL P
4	
5	
6	LVDT IN N
7	LVDT OUT N
8	COIL N
9	

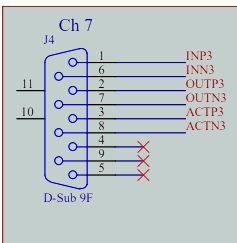

Title BS Suspension Cabling - Preisolator LVDT/Actuators			
Size A3	Number JGW-D1503600	Revision -v12	
Date: 2017/01/30	Sheet 6 of 16	Drawn By:	
File: \\...06 F0 LVDTs.SchDoc			

4 Feedthroughs

Preisolator Steppers

TMCM-6110
Stepper Driver #2

Stepper Splitter Cable
Double Motor Version

Stepper Driver #1
Chassis: JGW-D1605365
Board: TMCM-6110
Serial-Internet Converter:
MOXA NPort 5100A

OPTIONAL

Motor Cable Extension
JGW_D1503901 Sheet 16

PI to Flange Motor Cable
JGW-D1503901 Sheet 13

Feedthrough

Anti-Feedthrough Adapter Cable

Stepper External Cable

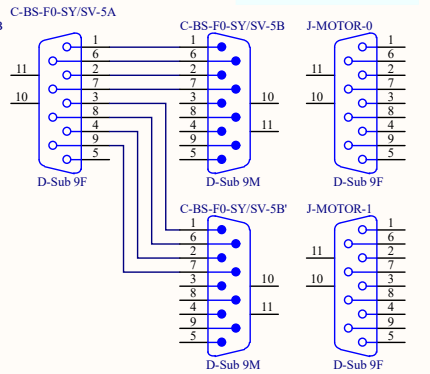
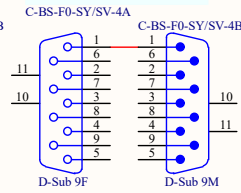
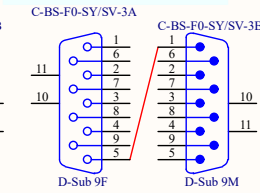
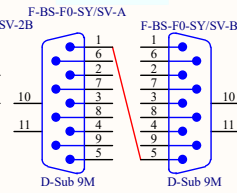
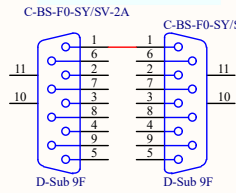
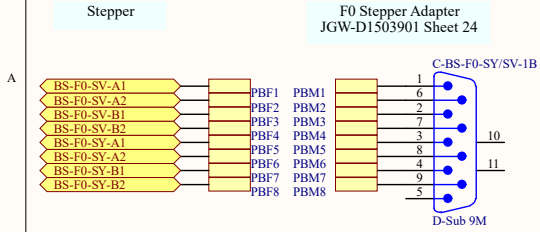

The vertical and yaw steppers have no limit switches and are combined on a single cable that VIS needs to provide.

The horizontal steppers have limit switches and will be wired as indicated by the IP manufacturer.

PI to Flange Motor Cable
JGW-D1503901 Sheet 13

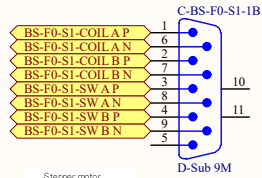

Pin	Function
1	COIL A P
2	COIL B P
3	Switch 1 P
4	Switch 2 P
5	
6	COIL A N
7	COIL B N
8	Switch 1 N
9	Switch 2 N

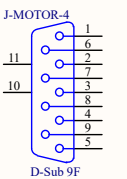
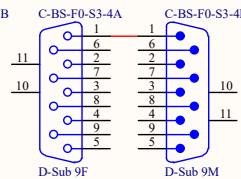
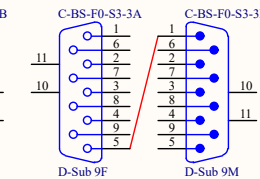
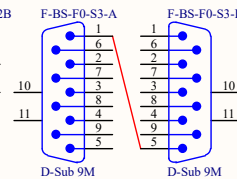
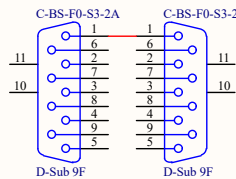
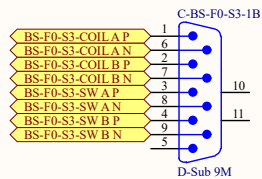
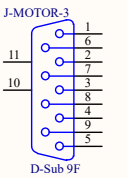
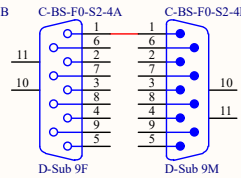
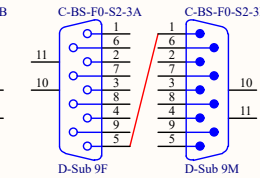
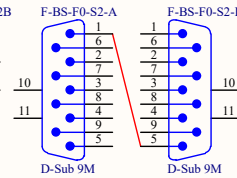
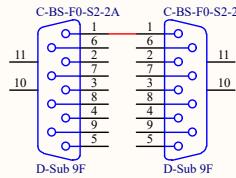
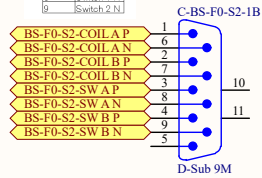
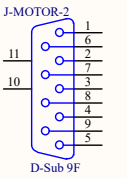
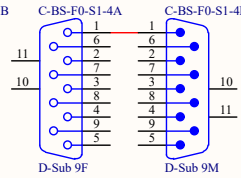
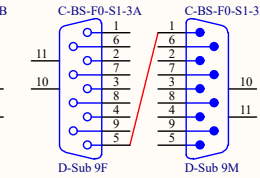
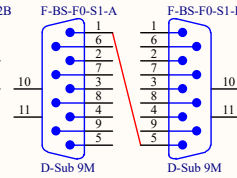
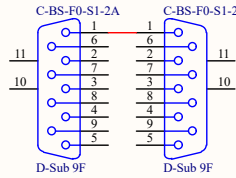

Title		
BS Suspension Cabling - Preisolator Steppers		
Size	Number	Revision
A3	JGW-D1503600	-v12
Date:	2017/01/30	Sheet 7 of 16
File:	\\..07 F0 Steppers.SchDoc	Drawn By:

3 Feedthroughs

Preisolator Geophones

Geophone Pod Internal Cabling
(same for all three pods):

Pod #1: geophone L400002322, preamp 15
Pod #2: geophone L400002321, preamp 12
Pod #3: geophone L400002323, preamp 14



Geophone Pod

Geophone Adapter Cable JGW-D1503901 Sheet 07

PI to Flange Geophone Cable JGW-E1503901 Sheet 11

Feedthrough

Anti-Feedthrough Adapter Cable

Geophone External Cable

Geophone Unscrambler Cable

Geophone Distributor JGW-D1402120

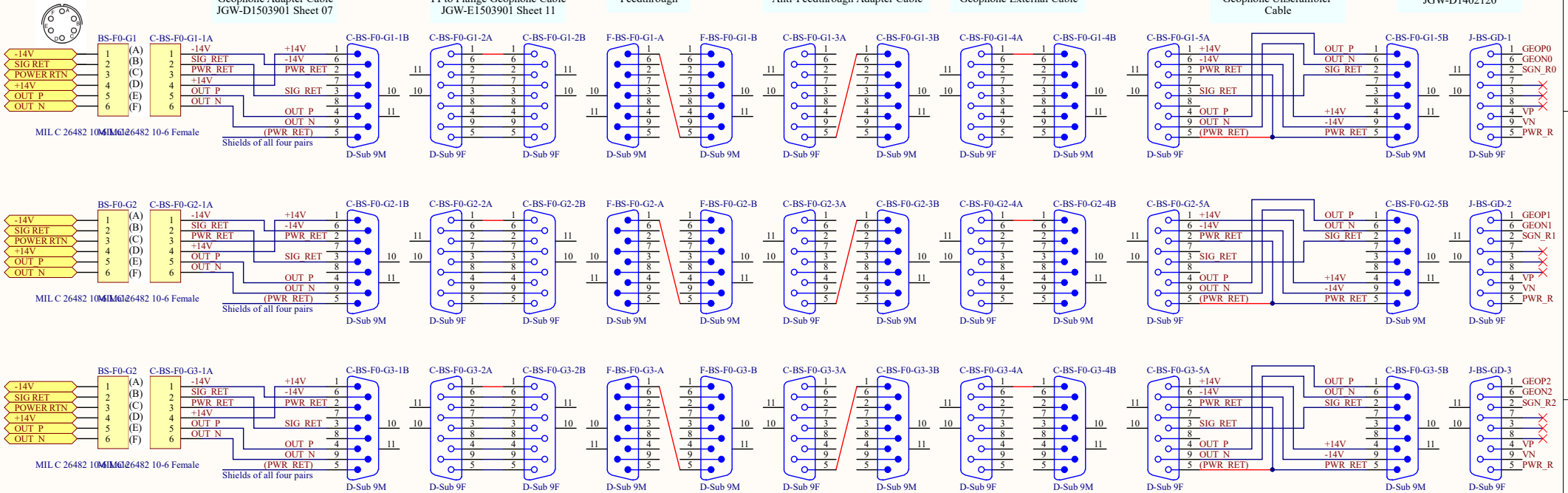

J-BS-GD-4 not used

Title			
BS Suspension Cabling - Preisolator Geophones			
Size	Number	Revision	
A3	JGW-D1503600	-v12	
Date:	2017/01/30	Sheet	8of 16
File:	\\.\08 F0 Geophones.SchDoc	Drawn By:	

OSEM Sat Amp and Driver - TM

Sat Amp #0

Chassis: JGW-D1503498,
Front Panel: JGW-D1503500,
Rear Panel: JGW-D1503500,
Board: JGW-D1503499

Inputs from TM
OSEMs
(see Sheet 1)

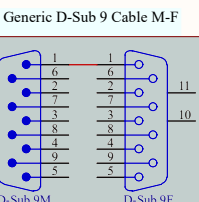
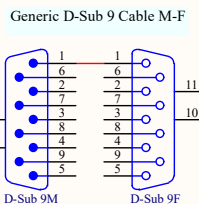
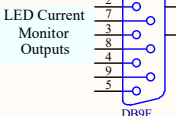
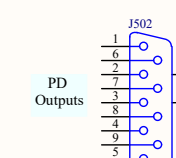
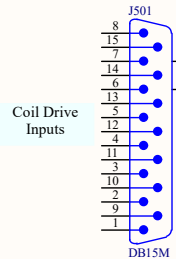
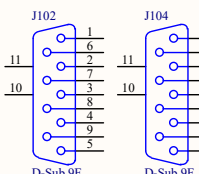
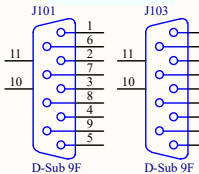

AI Chassis #0
D1100650

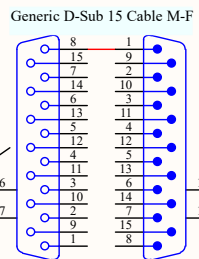
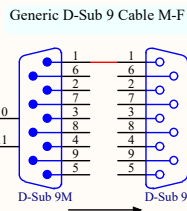
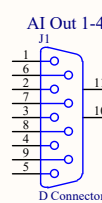

AA Chassis #1
D1100621

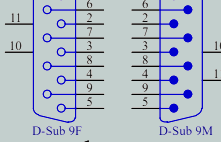
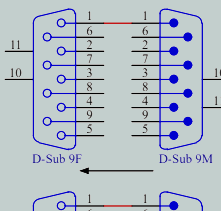
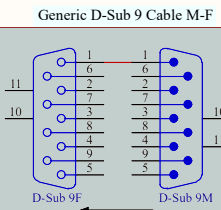
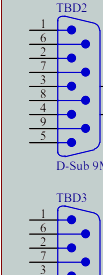
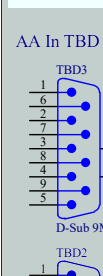

Low Power Coil Driver #0

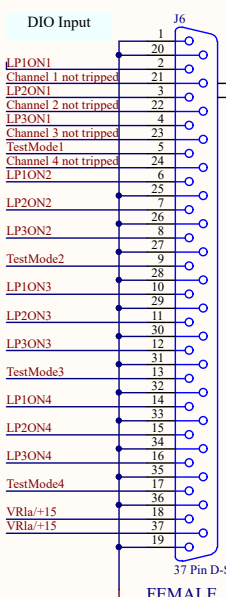
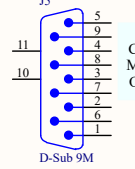
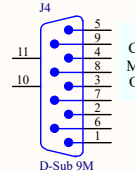
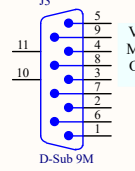
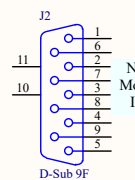
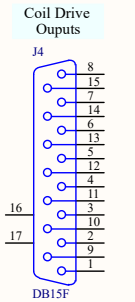
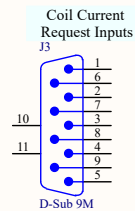

Chassis: JGW-D1503506,
Front Panel: JGW-D1503508,
Main Board: JGW-D1503507
BIO Board: JGW-D1504332

DIO Card #0

Contec DIO-6464L-PE

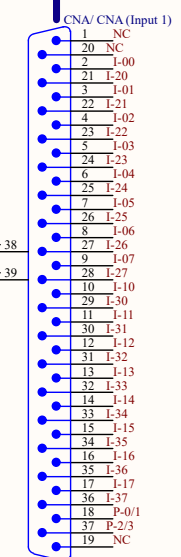
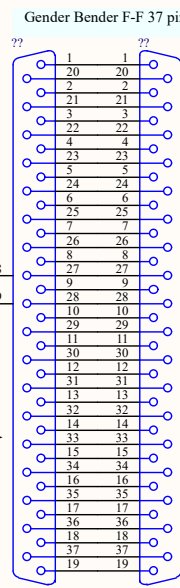
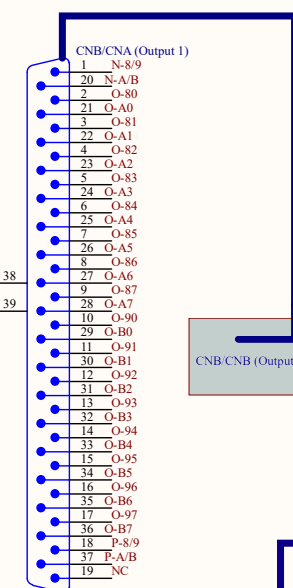
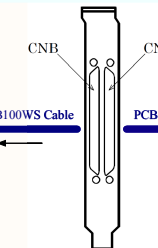

Title			BS Suspension Cabling - OSEM Sat Amps & Drivers - TM		
Size	Number	JGW-D1503600		Revision	-v12
A3				Sheet	9 of 16
Date:	2017/01/30			File: \\...09 Sat Amps & Coil Drivers OP.Sch/JobDrawn By:	

OSEM Sat Amp and Driver - IM 1

Sat Amp #1

Chassis: JGW-D1503498,
Front Panel: JGW-D1503500,
Rear Panel: JGW-D1503500,
Board: JGW-D1503499

Inputs from IM OSEMs
V1, V2, V3, H1
(see Sheet 2)

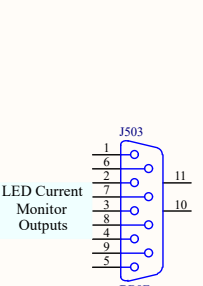
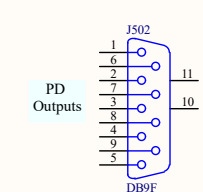
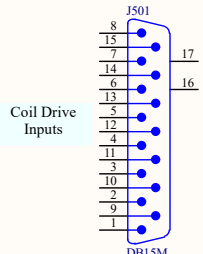
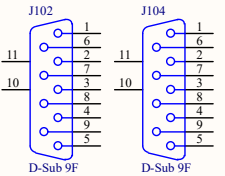
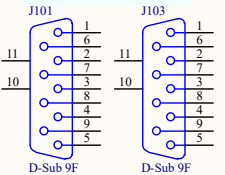

AI Chassis #0 D1100650

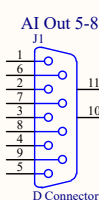

Generic D-Sub 9 Cable M-F

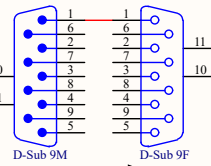

Generic D-Sub 15 Cable M-F

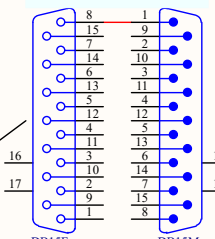

Low Power Coil Driver #1

Coil Current Request Inputs

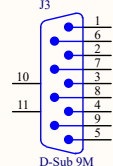

Coil Drive Outputs

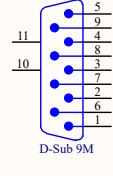
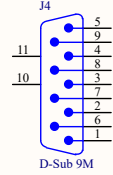
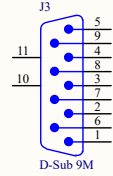
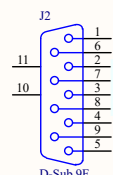
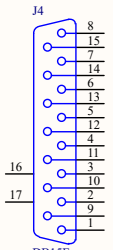

DIO Input

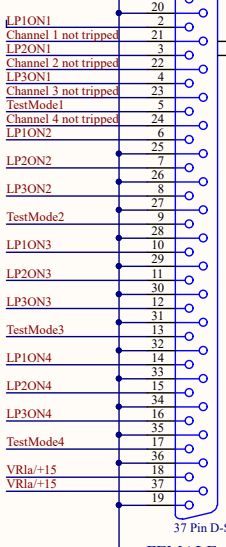

DIO Output

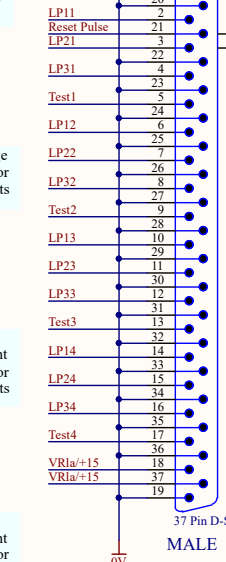

Chassis: JGW-D1503506,
Front Panel: JGW-D1503508,
Main Board: JGW-D1503507
BIO Board: JGW-D1504332

DIO Card #1

Contec DIO-6464L-PE

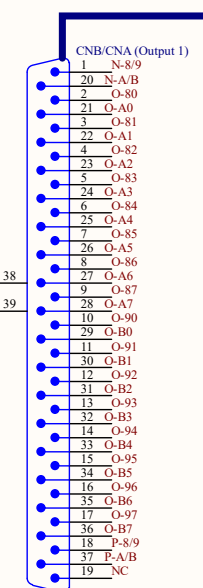
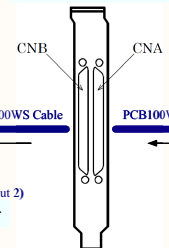

Gender Bender F-F 37 pin

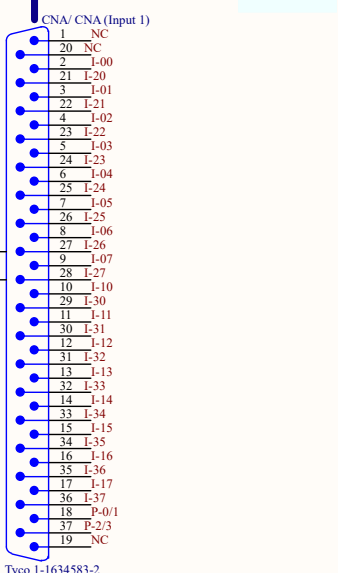
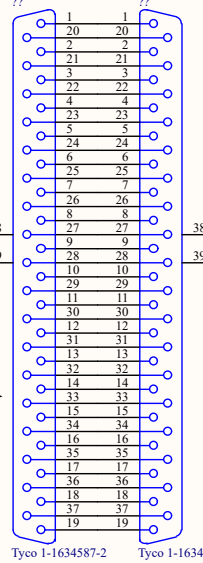

Title			
BS Suspension Cabling - OSEM Sat Amps & Drivers - IM 1			
Size	Number	Revision	
A3	JGW-D1503600	10	-v12
Date:	2017/01/30	Sheet of 16	
File:	\\..10 Sat Amps & Coil Drivers IM 1.Sch	Drawn By:	

OSEM Sat Amp and Driver - IM 2

Sat Amp #1

Chassis: JGW-D1503498,
Front Panel: JGW-D1503500,
Rear Panel: JGW-D1503500,
Board: JGW-D1503499

Inputs from IM
OSEMs H2, H3
(see Sheet 2)

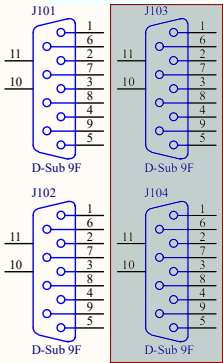

Coil Drive
Inputs

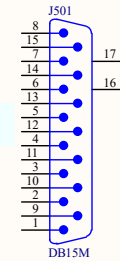

PD
Outputs

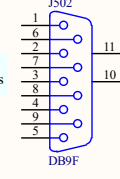

LED Current
Monitor
Outputs

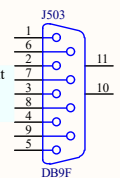

AI Chassis #0
D1100650

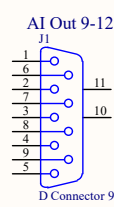

Generic D-Sub 9 Cable M-F

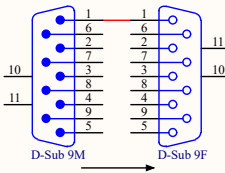

Generic D-Sub 15 Cable M-F

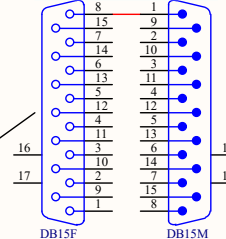

AA Chassis #1
D1100621

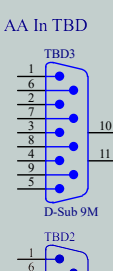

Generic D-Sub 9 Cable M-F

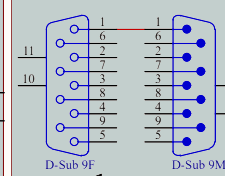

AA Chassis #0
D1100621

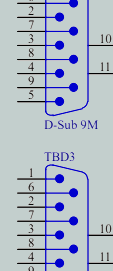

Generic D-Sub 9 Cable M-F

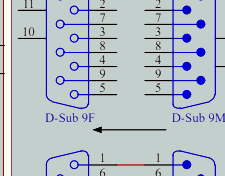

AA Chassis #1
D1100621

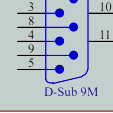

Generic D-Sub 9 Cable M-F

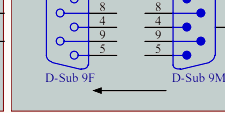

Low Power Coil Driver #2

Coil Current
Request Inputs

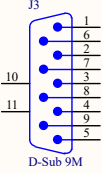

Coil Drive
Outputs

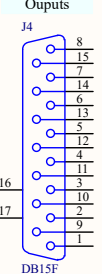

Noise
Monitor
Input

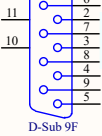

Voltage
Monitor
Outputs

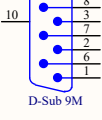

Fast
Current
Monitor
Outputs

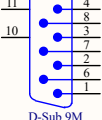

Slow
Current
Monitor
Outputs

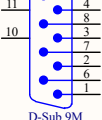

DIO Input

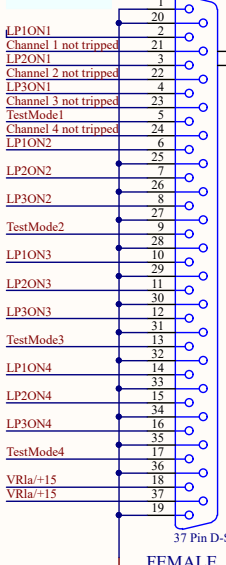

DIO Output

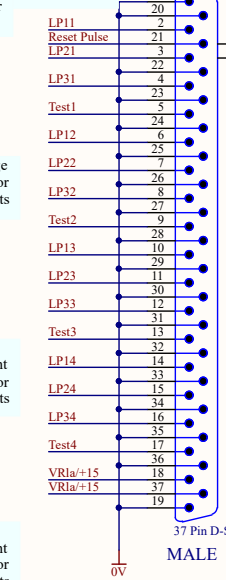

Chassis: JGW-D1503506,
Front Panel: JGW-D1503508,
Main Board: JGW-D1503507
BIO Board: JGW-D1504332

(DIO Card #1)

Contec DIO-6464L-PE

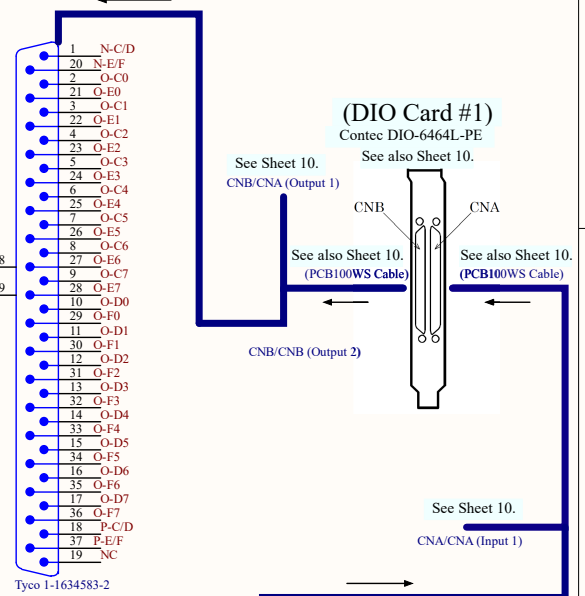

Gender Bender F-F 37 pin

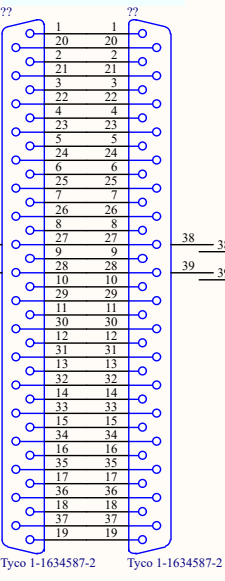

CNA/ CNA (Input 1)

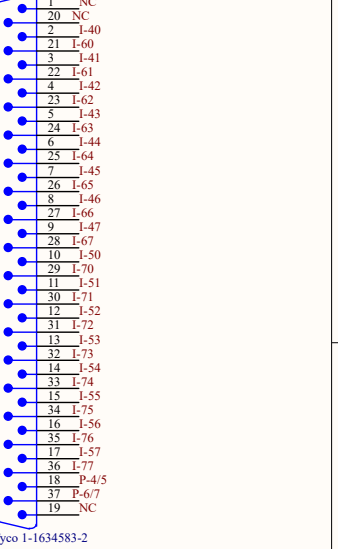

Title			
BS Suspension Cabling - OSEM Sat Amps & Drivers - IM 2			
Size	Number	Revision	
A3	JGW-D1503600	11	-v12
Date:	2017/01/30	Sheet of 16	
File:	\\.\11 Sat Amps & Coil Drivers IM 2.Sch1 Drawn By:		

BF&F1 LVDT Drivers

Inputs from BS&F1 LVDTs
(see Sheet 5)

LVDT/ACT Distributor - see also Sheet 13
Chassis: JGW-D1402124
Front Panel: JGW-D1402827
Rear Panel: JGW-D1402828
Board: JGW-D1402117

Ch 0-3 LVDT-IN

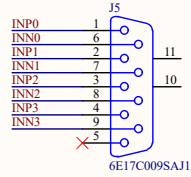

Ch 0

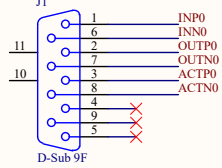

Ch 0-3 LVDT-OUT

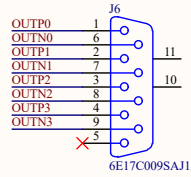

Ch 1

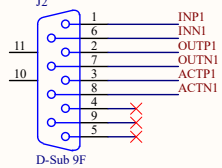

Ch 0-3 ACT

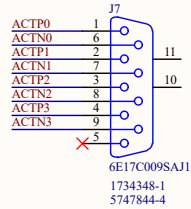

2 inputs unused

Ch 2
Ch 3

Generic D-Sub 9 Cable M-F

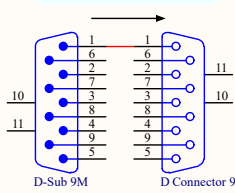

Generic D-Sub 9 Cable M-F

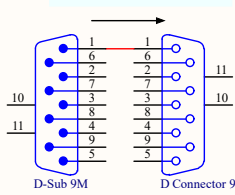

LVDT-Coil Driver Cable

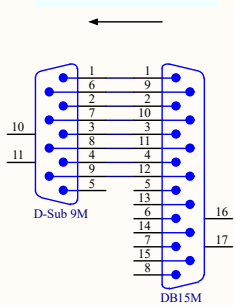

LVDT Driver - see also Sheet 13
Chassis: JGW-D1402826,
Main Board: JGW-D1301467
Input Boards (2): JGW-D1301467
Front Panel: JGW-D1402827

LVDT CARD 1 (Left)

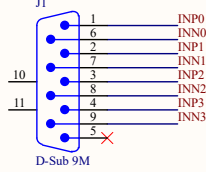

LVDT MAIN (Left)

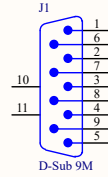

LVDT CARD 1 (Right)

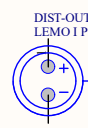
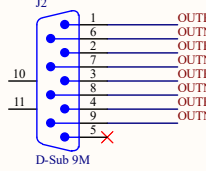

Gender Bender F-F

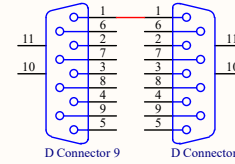

Generic D-Sub 9 Cable M-F

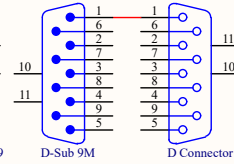

AA Chassis #0
JGW-D1100621

AA In 12-15

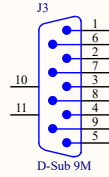

The LVDT Chassis has provision for an oscillator card, but until such time as the cards are available, an external oscillator will be required

Signal Generator
10 kHz, 5 V



High Power Coil Driver #1
Chassis: JGW-D1503504
Front Panel: JGW-D1503502
Rear Panel: JGW-D1503505,
Monitor Board: JGW-D1503510

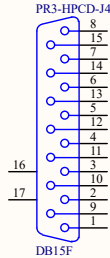

Generic D-Sub 9 Cable M-F

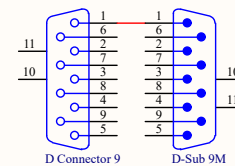

AI Chassis #1
D1101521

AI Out 1-4

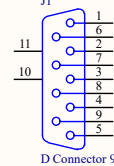

Title BS Suspension Cabling - BF&F1 LVDT Drivers		
Size A3	Number JGW-D1503600	Revision -v12
Date: 2017/01/30	Sheet 12	of 16
File: \\...12 BF&F1 LVDT Drive.SchDoc	Drawn By:	

**Inputs from F0
LVDTs
(see Sheet 6)**

(LVDT/ACT Distributor - see Sheet 12)
Chassis: JGW-D1402124,
Front Panel: JGW-D1402827
Rear Panel: JGW-D1402828,
Board: JGW-D1402117 #1

Front Panel

Rear Panel

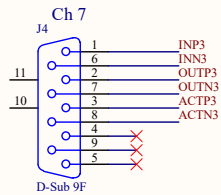
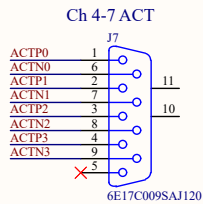
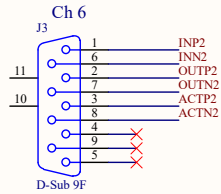
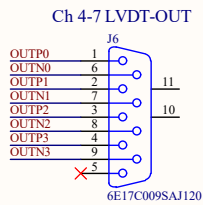
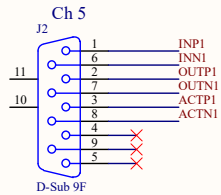
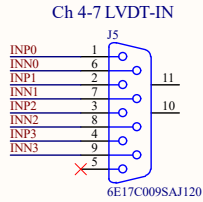
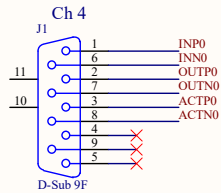

F0 LVDT Drivers

(LVDT Driver - see Sheet 12)
Chassis: JGW-D1402826,
Main Board: JGW-D1301467
Input Boards (2): JGW-D1301467
Front Panel: JGW-D1402827

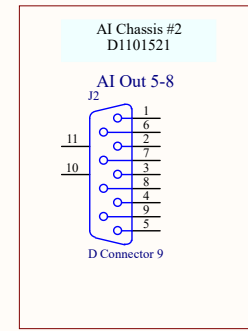
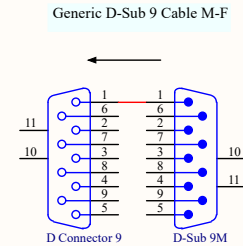
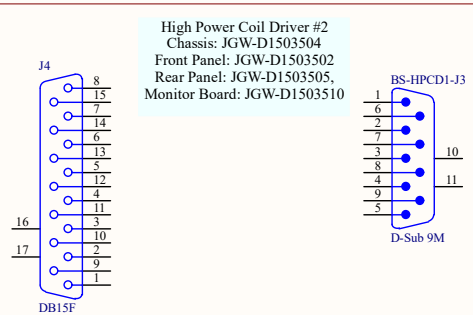
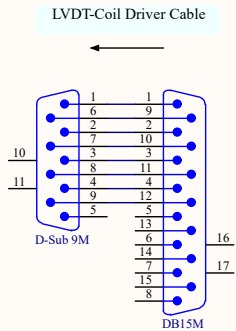
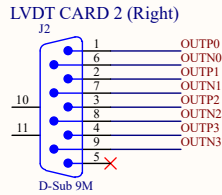
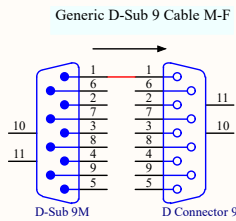
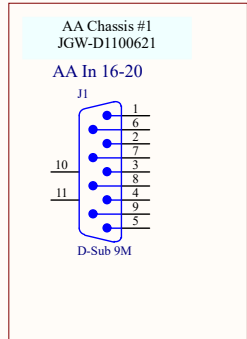
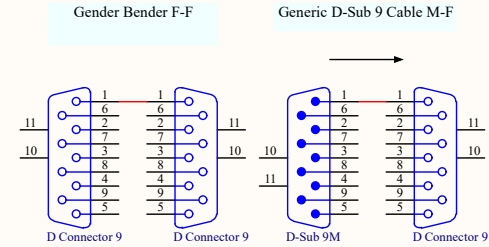
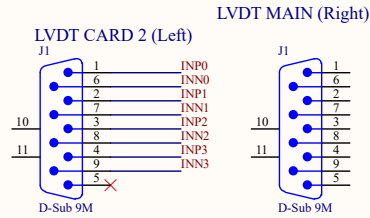
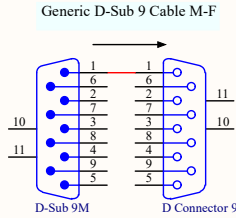

Title			BS Suspension Cabling - F0LVDT Drivers		
Size	Number	Revision			
A3	JGW-D1503600	13	-v12		
Date:	2017/01/30	Sheet of		16	
File:	\\.\13 F0 LVDT Drive.SchDoc	Drawn By:			

Pico and Stepper Drivers

Stepper Driver #1
 Chassis: JGW-D1605365
 Board: TMCM-6110
 Serial: MOXA NPort 5100A

**BOX STILL IN DESIGN!!!
 GUESS AT FINAL PINOUT!!!**

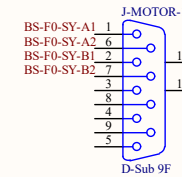
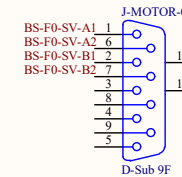

NOTE: 3 channels use switches

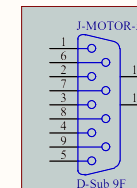
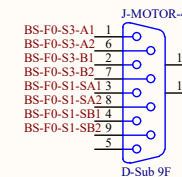
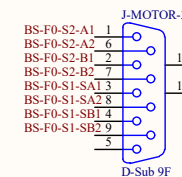
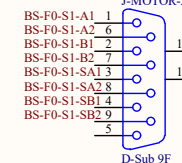

Outputs to F0
 Steppers
 (see Sheet 7)

Pico and Stepper Drivers

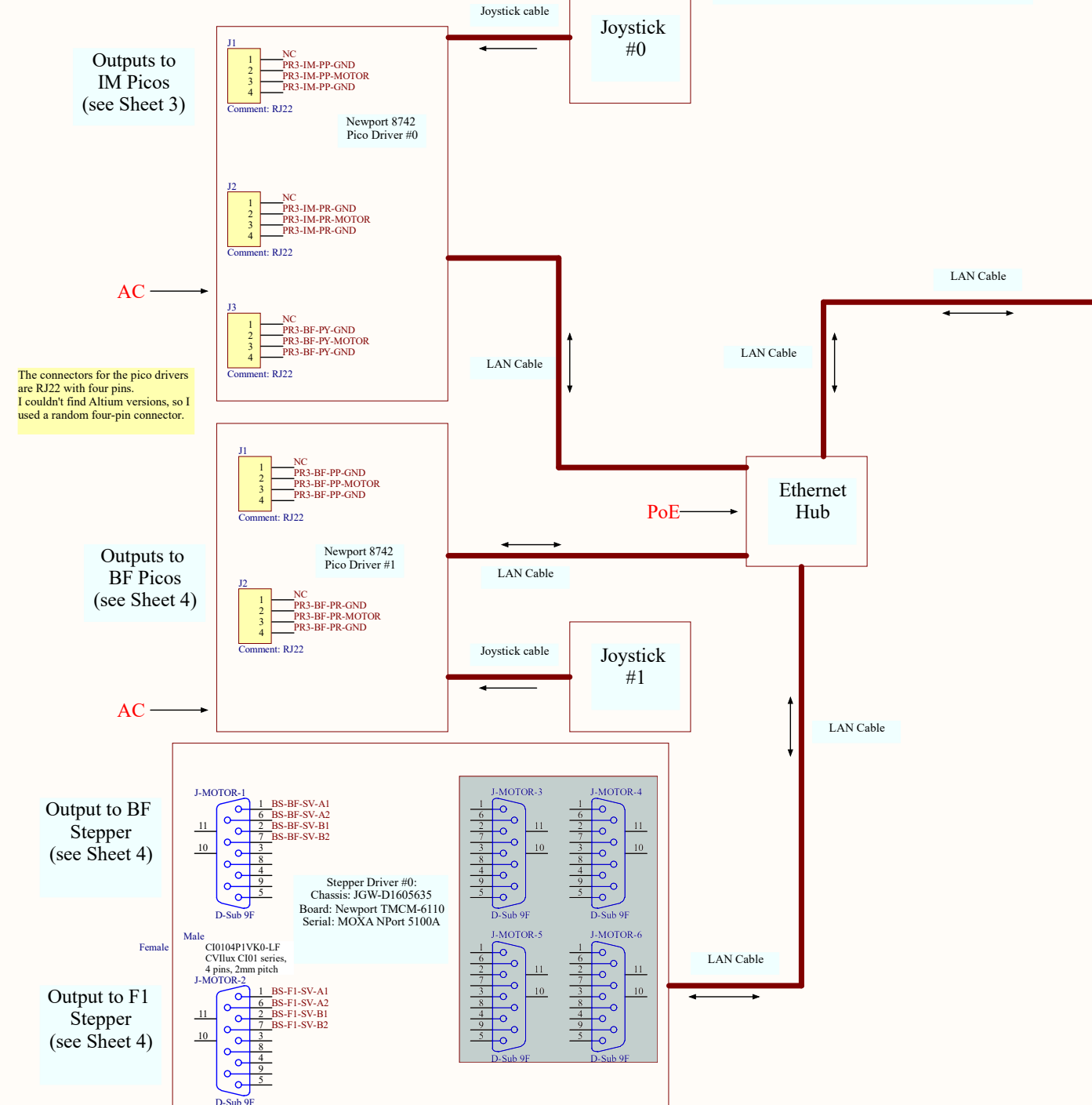

Outputs to IM Picos
 (see Sheet 3)

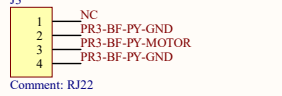
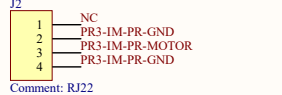
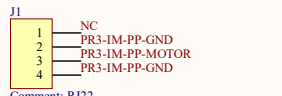

Outputs to BF Picos
 (see Sheet 4)

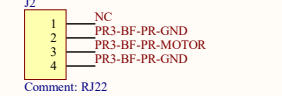
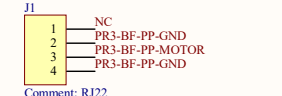

The connectors for the pico drivers are RJ22 with four pins. I couldn't find Altium versions, so I used a random four-pin connector.

Output to BF Stepper
 (see Sheet 4)

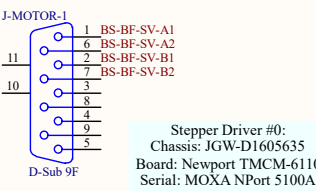

Stepper Driver #0:
 Chassis: JGW-D1605635
 Board: Newport TMCM-6110
 Serial: MOXA NPort 5100A

Female

Male
 C10104P1VK0-LF
 CVIlux C101 series,
 4 pins, 2mm pitch

Output to F1 Stepper
 (see Sheet 4)

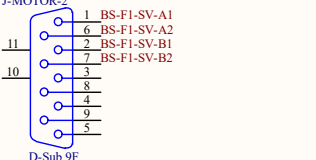

Title			BS Suspension Cabling - Pico and Stepper Drivers		
Size	Number			Revision	
A3	JGW-D1503600			-v12	
Date:	2017/01/30	Sheet	of	16	
File:	\\.\14 Pico&Stepper Drive.SchDoc	Drawn By:			

3 Feedthroughs

Geophone Readout

Inputs from F0 Geophones (see Sheet 8)

Geophone Distributor
D1402120
Front Panel
D1402122
Board
D1402121

Geophone Distributor
D1402120
Rear Panel
D1402123
Board
D1402121

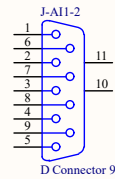
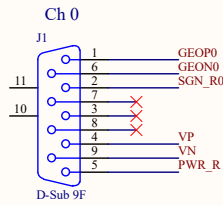

Generic D-Sub 9 Cable M-F

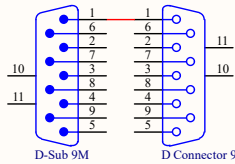

AA Chassis #0
JGW-D1100621

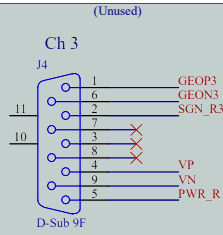
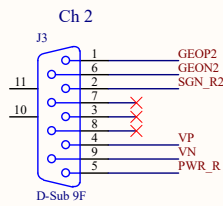
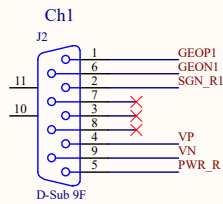
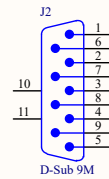

Title			BS Suspension Cabling - Geophone Readout		
Size	Number		Revision		
A3	JGW-D1503600	15	-v12		
Date:	2017/01/30	Sheet	of	16	
File:	\\..15 Geophone Readout.SchDoc	Drawn By:			

OpLev Etc

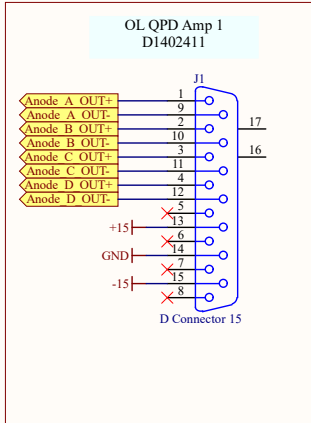

Generic D-Sub 15 Cable M-F

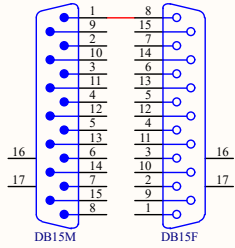

Generic D-Sub 15 Cable M-F

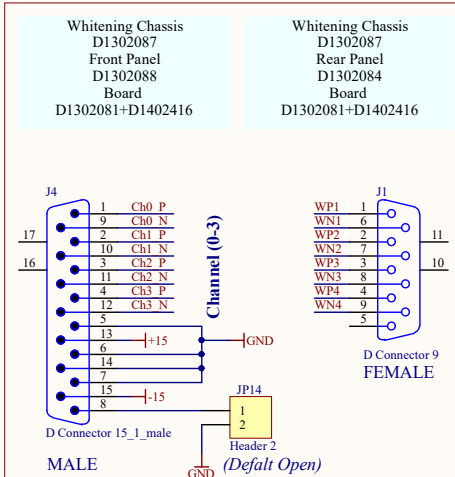
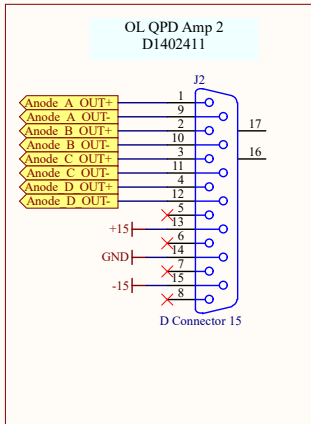
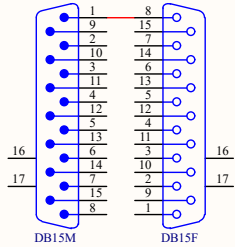

Generic D-Sub 9 Cable M-F

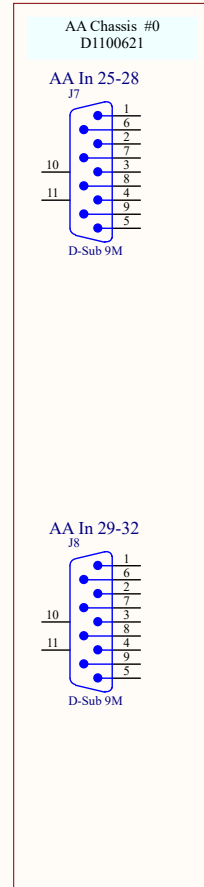
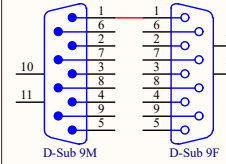

Generic D-Sub 9 Cable M-F

