

4 Feedthroughs

OP OSEMs

Incorporates flip to correct flexicircuit issue!!!

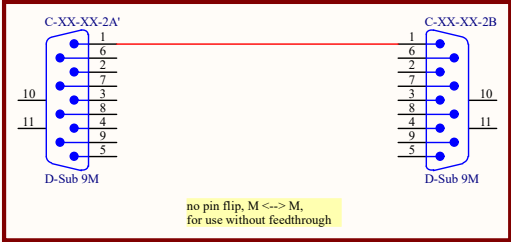
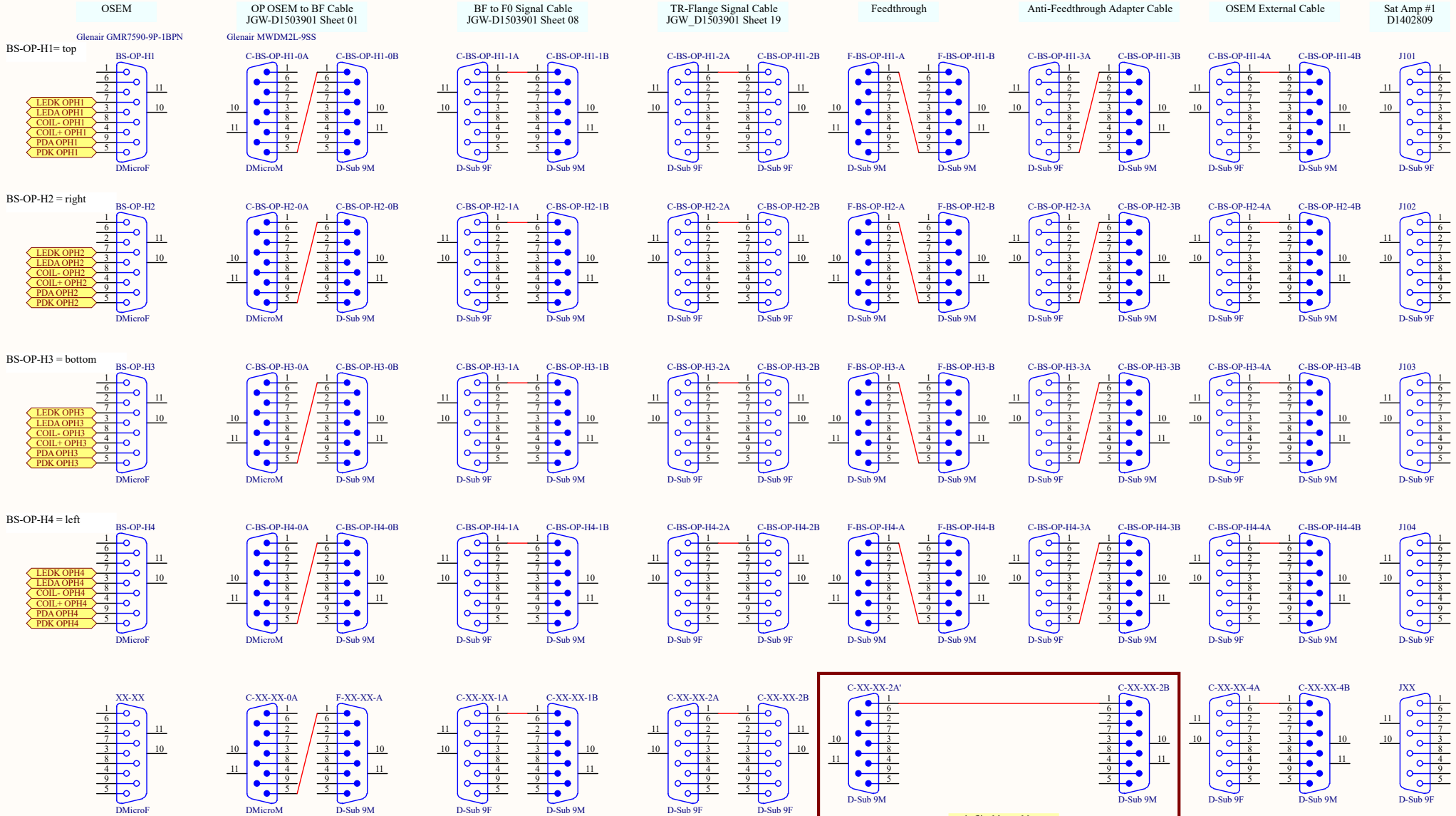

For testing the suspension outside the vacuum tank, there should be a supply of plain M-M gender changers to replace the combination of Feedthrough+Anti-Feedthrough adapter cable.

| | | |
|---|-------------------------|---------------|
| Title | | |
| BS Suspension Cabling - Test Mass OSEMs | | |
| Size | Number | Revision |
| A3 | JGW-D1503600 | -v11 |
| Date: | 2016/11/01 | Sheet 1 of 16 |
| File: | \\...01 OP OSEMs.SchDoc | Drawn By: |

6 Feedthroughs

Incorporates flip to correct flexicircuit issue!!!

IM OSEMs

OSEM

IM OSEM to BF Cable
JGW-D1503901 Sheet 02

BF to F0 Signal Cable
JGW-D1503901 Sheet 08

TR-Flange Signal Cable
JGW-D1503901 Sheet 19

Feedthrough

Anti-Feedthrough Adapter Cable

OSEM External Cable

Sat Amp #2
D1402809

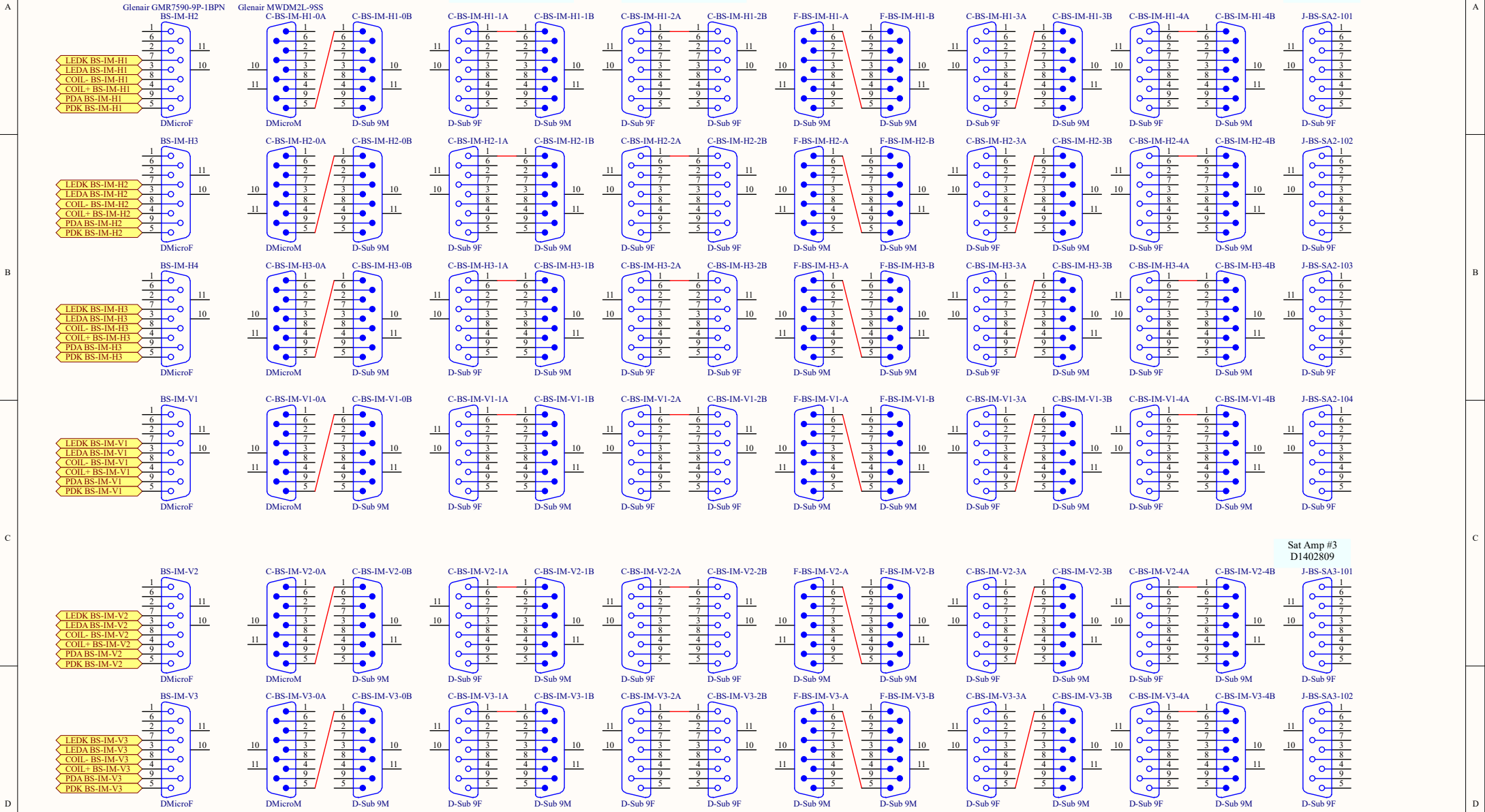

J-BS-SA3-103 and J-BS-SA3-104 not used

| | | | |
|--|------------------------|------------------|-----------|
| Title BS Suspension Cabling - Intermediate Mass OSEMs | | | |
| Size A3 | Number JGW-D1503600 | Revision -v11 | |
| Date 2016/11/01 | Sheet 7 of 16 | | Drawn By: |
| File \\..02 IM OSEMs.SchDoc | | | |

1 Feedthrough

IM Picomotors

In -v10, the BS Yaw Pico was moved to the IM sheet and grouped with the IM picos, because it's more physically convenient for wiring and more logical (it actually rotates the IM).

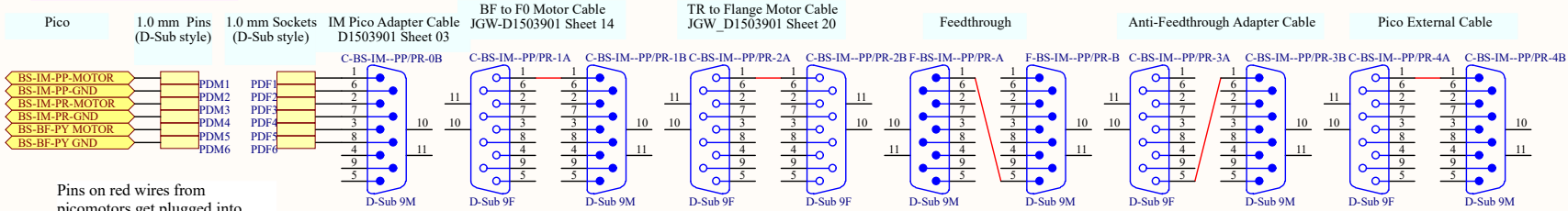

Pins on red wires from picomotors get plugged into sockets from pins 1, 2, 3.

Pins on white wires from picomotors get plugged into sockets from pins 6, 7, 8.

The pico motor at the bottom level of the IM does pitch and gets plugged into 1&6.

The pico motor at the top level of the IM does roll and gets plugged into 2&7.

The pico motor in the BS does IM yaw and gets plugged into 3&8.

The connectors for the pico drivers are RJ22 with four pins. I couldn't find Altium versions, so I used a random four-pin connector.

The adapter cable is made by combining the cables supplied by the pico manufacturer (Newport) with a D-Sub 9 female.

Green wires from manufacturer's cables get soldered to pins 1, 2.

Yellow wires from manufacturer's cables get soldered to pins 6, 7.

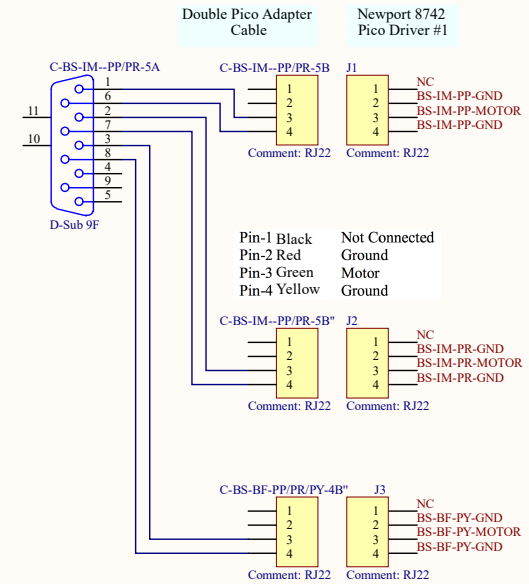

| | | | |
|--|------------------------|------------------|--|
| Title BS Suspension Cabling - Intermediate Mass Picos | | | |
| Size A3 | Number JGW-D1503600 | Revision -v11 | |
| Date: 2016/11/01 | Sheet 3 of 16 | Drawn By: | |
| File: \\.\03 IM Picos.SchDoc | | | |

3 Feedthroughs

In -v10, the BS Yaw Pico was moved to the IM sheet and grouped with the IM picos, because it's more physically convenient for wiring and more logical (it actually rotates the IM).

BF and F1 Picomotors and Steppers

The connectors for the pico drivers are RJ22 with four pins. I couldn't find Altium versions, so I used a random four-pin connector.

Pin-1 Black Not Connected
Pin-2 Red Ground
Pin-3 Green Motor
Pin-4 Yellow Ground

Picos 1.0 mm Pins (D-Sub style) 1.0 mm Sockets (D-Sub style) BF Pico Adapter Cable D1503901 Sheet 04

BF to F0 Motor Cable JGW-D1503901 Sheet 14

TR to Flange Motor Cable JGW-D1503901 Sheet 20

Feedthrough

Anti-Feedthrough Adapter Cable

Pico External Cable

Pico Adapter Cable

Newport 8742 Pico Driver #2

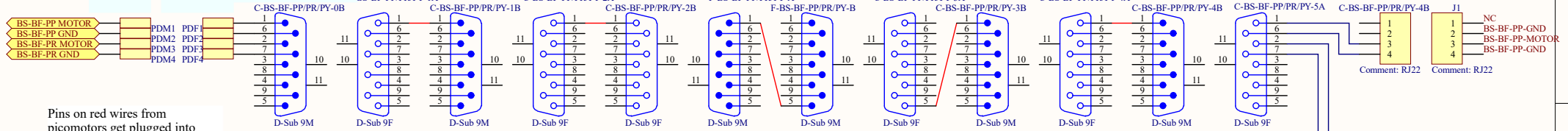

Pins on red wires from picomotors get plugged into sockets from pins 1, 2.

Pins on white wires from picomotors get plugged into sockets from pins 6, 7.

The adapter cable is made by combining the cables supplied by the pico manufacturer (Newport) with a D-Sub 9 female.

Green wires from manufacturer's cables get soldered to pins 1, 2, 3.

Yellow wires from manufacturer's cables get soldered to pins 6, 7, 8.

Steppers 1.6 mm Sockets (Burndy) 1.6 mm Pins (Burndy) BF&F1 Stepper Adapter Cable D1503901 Sheet 05

BF to F0 Motor Cable JGW-D1503901 Sheet 14

SUS to Flange Motor Cable JGW-D1503901 Sheet 20

Feedthrough

Anti-Feedthrough Adapter Cable

Stepper External Cable

Stepper Adapter Cable

Stepper Driver #1 Chassis: JGW-D1605365 Board: TCMC-6110 Serial-Internet Converter: MOXA NPort 5100A

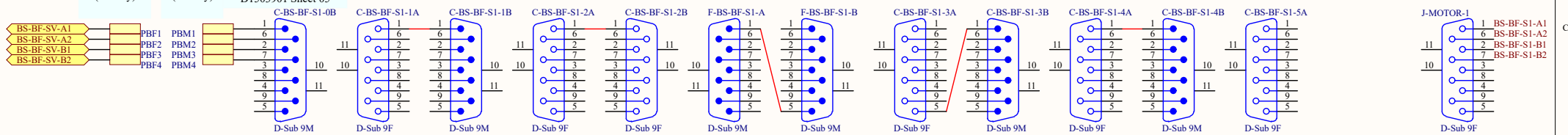

F1 to F0 Motor Cable JGW-D1503901 Sheet 15

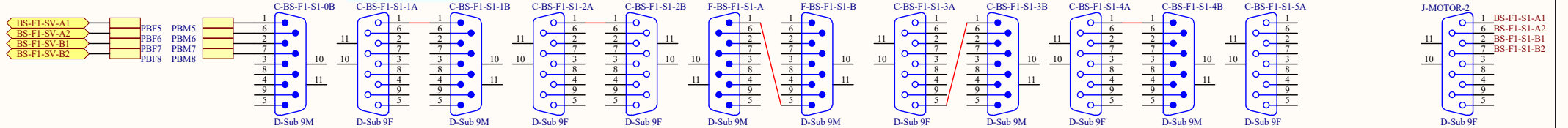

| | | | |
|---|------------------------------------|---------------|--|
| Title | | | |
| BS Suspension Cabling - Bottom and Standard Filter Picos/Steppers | | | |
| Size | Number | Revision | |
| A3 | JGW-D1503600 | -v11 | |
| Date: | 2016/11/01 | Sheet 4 of 16 | |
| File: | \\.\04 BF&F1 Picos&Steppers.SchDoc | Drawn By: | |

BF and F1 LVDT/ACTs

2 Feedthroughs

LVDT/ACT Distributor - see also Sheet 12
 Chassis: JGW-D1402124
 Front Panel: JGW-D1402827
 Rear Panel: JGW-D1402828
 Board: JGW-D1402117

LVDT/Act

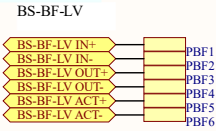

BF&F1 LVDT Adapter Cable
 JGW-D1503901 Sheet 06

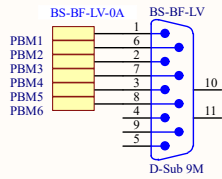

BF-F0 Signal Cable
 JGW-D1503901 Sheet 08

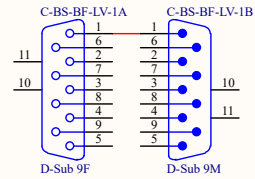

TR-Flange Signal Cable
 JGW_D1503901 Sheet 19

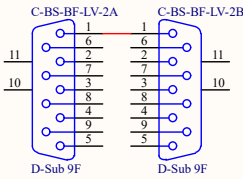

Feedthrough

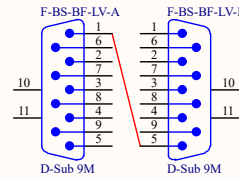

Feedthrough Adapter Cable

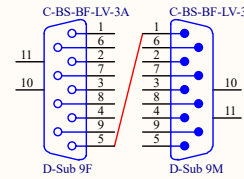

External Cable

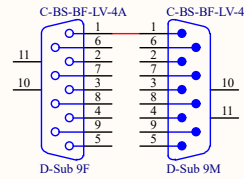

Ch 0

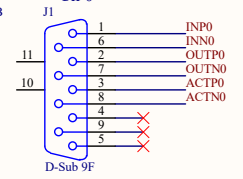

LVDT/Act

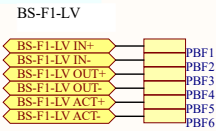

BF&F1 LVDT Adapter Cable
 JGW-D1503901 Sheet 06

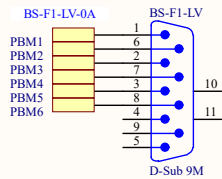

F1-F0 Signal Cable
 JGW-D1503901 Sheet 09

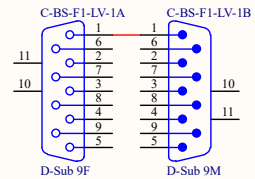

TR-Flange Signal Cable
 JGW_D1503901 Sheet 19

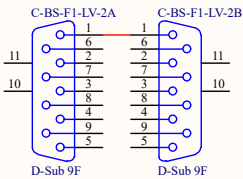

Feedthrough

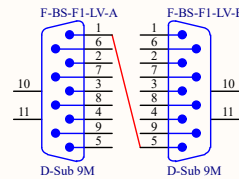

Feedthrough Adapter Cable

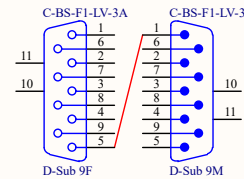

External Cable

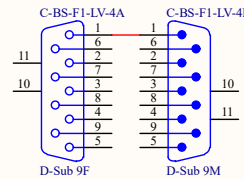

Ch 1

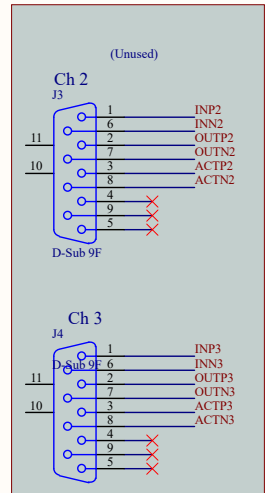
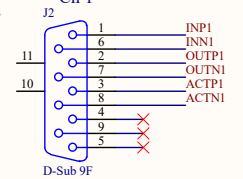

| | | | |
|--|---------------------------|---------------|--|
| Title | | | |
| BS Suspension Cabling - Bottom and Standard Filter LVDTs | | | |
| Size | Number | Revision | |
| A3 | JGW-D1503600 | -v11 | |
| Date: | 2016/11/01 | Sheet 5 of 16 | |
| File: | \\.\05 BF&F1 LVDTs.SchDoc | Drawn By: | |

4 Feedthroughs

Preisolator LVDT/ACTs

LVDT/ACT Distributor - see also Sheet 13
 Chassis: JGW-D1402124
 Front Panel: JGW-D1402827
 Rear Panel: JGW-D1402828
 Board: JGW-D1402117

LVDT/ACT

OPTIONAL
 Signal Cable Extension
 JGW_D1503901 Sheet 10

TR-Flange Signal Cable
 JGW_D1503901 Sheet 19

Feedthrough

Anti-Feedthrough Adapter Cable

LVDT/ACT External Cable

Ch 4

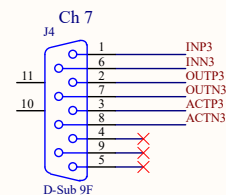
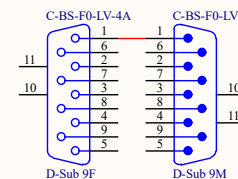
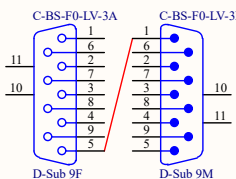
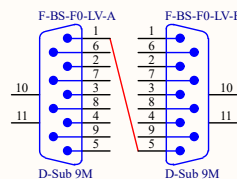
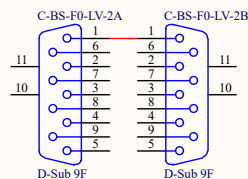
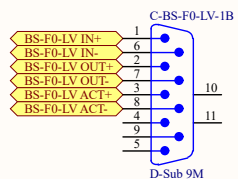
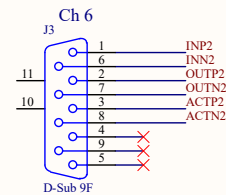
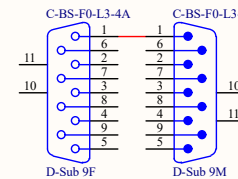
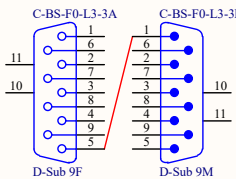
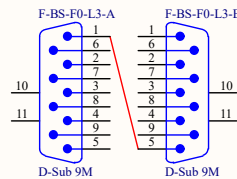
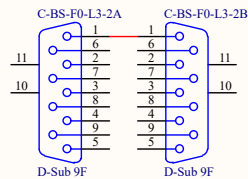
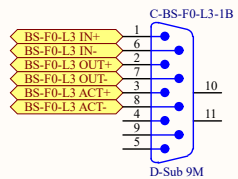
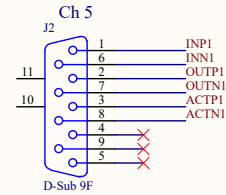
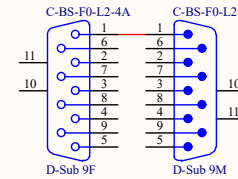
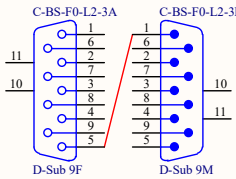
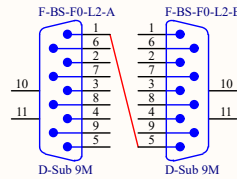
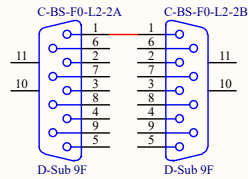
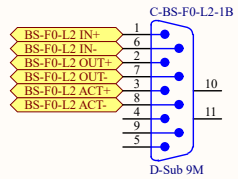
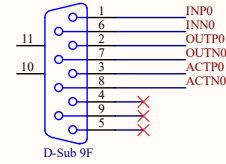
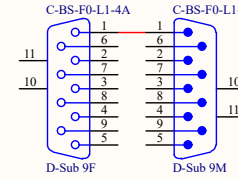
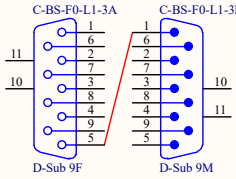
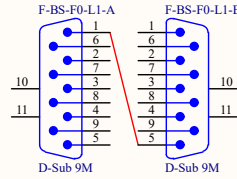
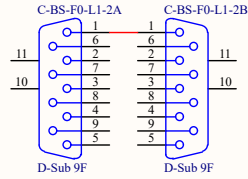
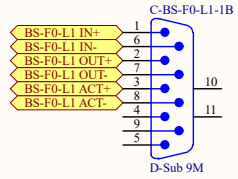

LVDT-COIL

| Pin | Function |
|-----|------------|
| 1 | LVDT IN P |
| 2 | LVDT OUT P |
| 3 | COIL P |
| 4 | |
| 5 | |
| 6 | LVDT IN N |
| 7 | LVDT OUT N |
| 8 | COIL N |
| 9 | |

| Title | | | |
|--|------------------------|-----------|--------|
| BS Suspension Cabling - Preisolator LVDT/Actuators | | | |
| Size | Number | Revision | |
| A3 | JGW-D1503600 | -v11 | |
| Date: | 2016/11/01 | Sheet | 6of 16 |
| File: | \\.\06 F0 LVDTs.SchDoc | Drawn By: | |

4 Feedthroughs

Preisolator Steppers

TMCM-6110
Stepper Driver #2

Stepper Driver #2
Chassis: JGW-D1605365
Board: TMCM-6110
Serial-Internet Converter:
MOXA NPort 5100A

OPTIONAL

Motor Cable Extension
JGW_D1503901 Sheet 16

F0 Stepper Adapter
JGW-D1503901 Sheet 24

F0 to Flange Motor Cable
JGW-D1503901 Sheet 20

Feedthrough

Anti-Feedthrough Adapter Cable

Stepper External Cable

Stepper Splitter Cable
Double Motor Version

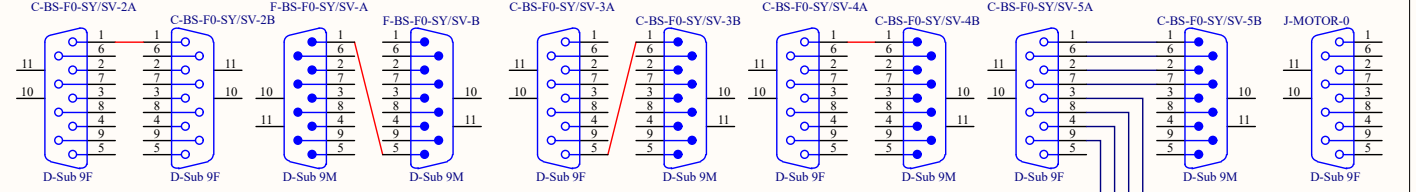
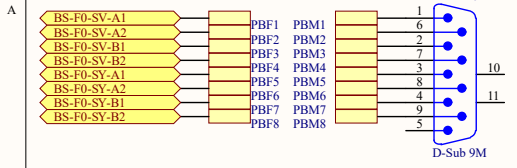

The vertical and yaw steppers have no limit switches and are combined on a single cable that VIS needs to provide.

The horizontal steppers have limit switches and will be wired as indicated by the IP manufacturer.

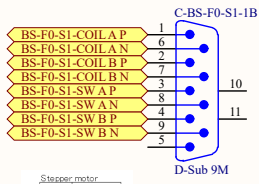

| Pin | Function |
|-----|------------|
| 1 | COIL A P |
| 2 | COIL B P |
| 3 | Switch 1 P |
| 4 | Switch 2 P |
| 5 | |
| 6 | COIL A N |
| 7 | COIL B N |
| 8 | Switch 1 N |
| 9 | Switch 2 N |

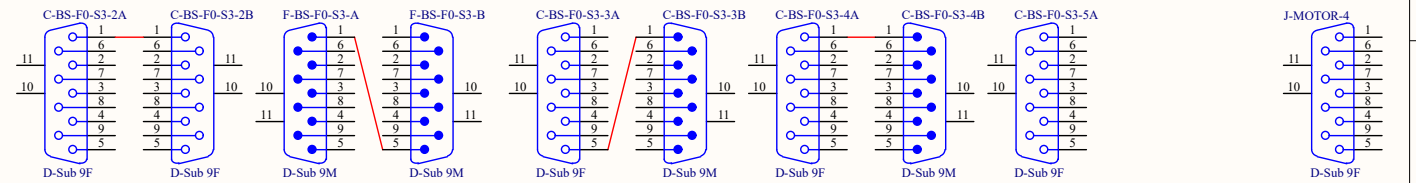
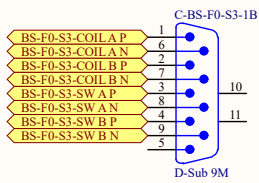
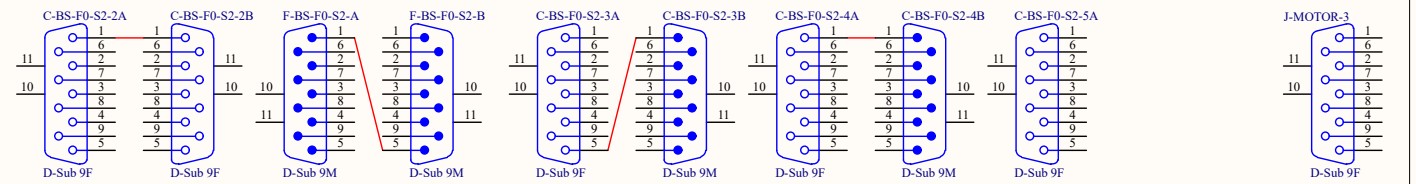
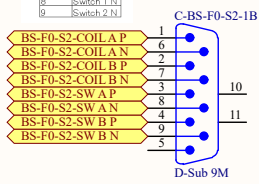
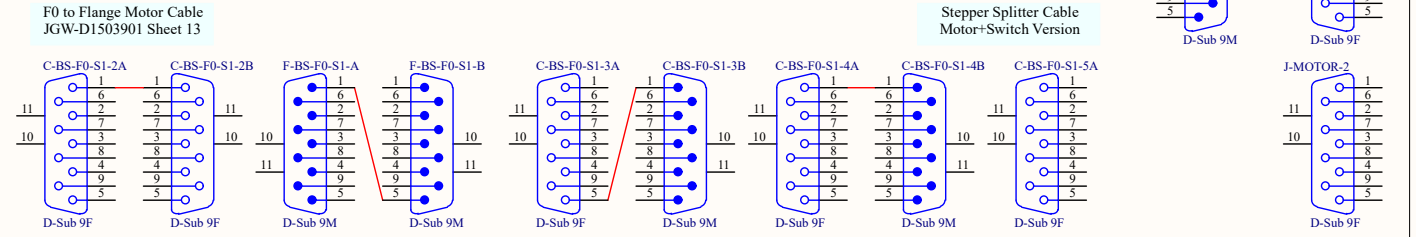

| | | |
|---|------------------------|------------------|
| Title BS Suspension Cabling - Preisolator Steppers | | |
| Size A3 | Number JGW-D1503600 | Revision -v11 |
| Date 2016/11/01 | Sheet 7 of 16 | Drawn By: |
| File: \\..07 F0 Steppers.SchDoc | | |

3 Feedthroughs

Preisolator Geophones

Geophone Pod Internal Cabling
(same for all three pods):

Pod #1: geophone L400002322, preamp 15
Pod #2: geophone L400002321, preamp 12
Pod #3: geophone L400002323, preamp 14

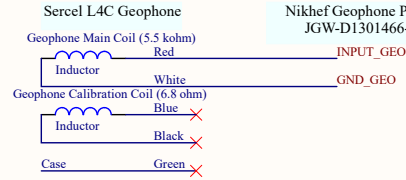

Note: The usual TR to Flange Signal Cable (D1503901 Sheet 19) cannot be used here because it doesn't have a conductor on Pin 5!!!



Geophone Pod

Geophone Adapter Cable
JGW-D1503901 Sheet 07

F0 to Flange Geophone Cable
JGW-E1503901 Sheet 12

Feedthrough

Anti-Feedthrough Adapter Cable

Geophone External Cable

Geophone Distributor
JGW-D1402120

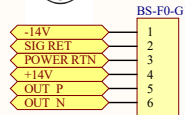

MIL C 26482 10-6 Male

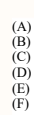

MIL C 26482 10-6 Female

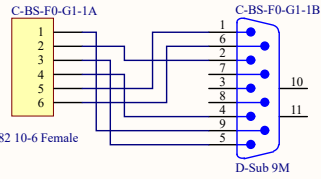

D-Sub 9M

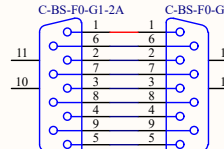

D-Sub 9F

D-Sub 9F

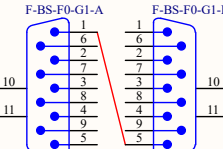

D-Sub 9M

D-Sub 9M

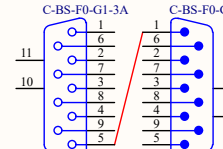

D-Sub 9F

D-Sub 9M

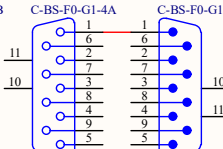

D-Sub 9F

D-Sub 9M

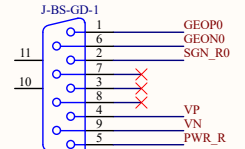

D-Sub 9F

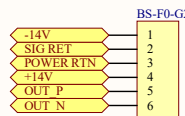

MIL C 26482 10-6 Male

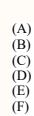

MIL C 26482 10-6 Female

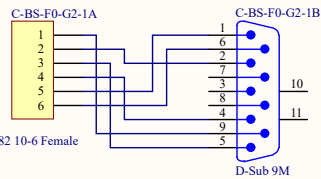

D-Sub 9M

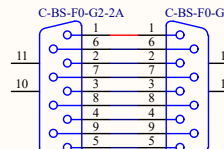

D-Sub 9F

D-Sub 9F

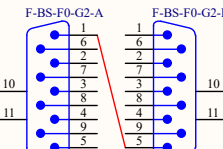

D-Sub 9M

D-Sub 9M

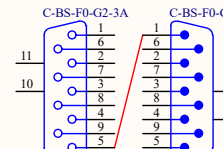

D-Sub 9F

D-Sub 9M

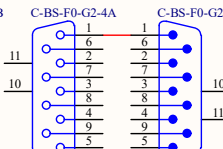

D-Sub 9F

D-Sub 9M

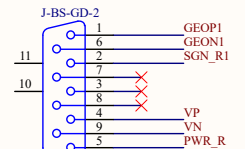

D-Sub 9F

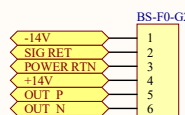

MIL C 26482 10-6 Male

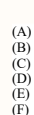

MIL C 26482 10-6 Female

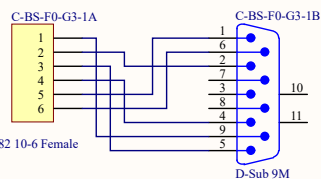

D-Sub 9M

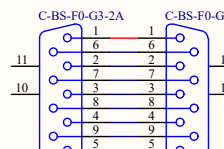

D-Sub 9F

D-Sub 9F

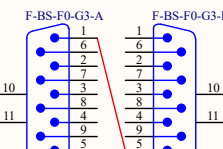

D-Sub 9M

D-Sub 9M

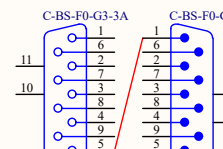

D-Sub 9F

D-Sub 9M

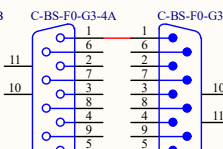

D-Sub 9F

D-Sub 9M

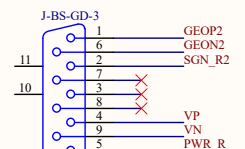

D-Sub 9F

J-BS-GD-4 not used

| | | |
|--|------------------------|------------------|
| Title BS Suspension Cabling - Preisolator Geophones | | |
| Size A3 | Number JGW-D1503600 | Revision -v11 |
| Date: 2016/11/01 | Sheet 8of 16 | |
| File: \\.\08 F0 Geophones.SchDoc | Drawn By: | |

OSEM Sat Amp and Driver - OP

Sat Amp #1

Chassis: JGW-D1503498,
Front Panel: JGW-D1503500,
Rear Panel: JGW-D1503500,
Board: JGW-D1503499

Inputs from OP OSEMs (see Sheet 1)

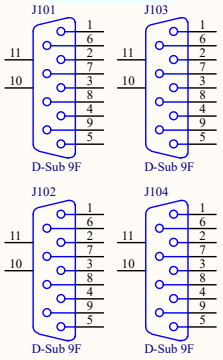

Coil Drive Inputs

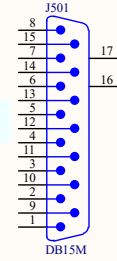

PD Outputs

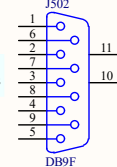

LED Current Monitor Outputs

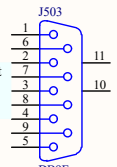

AI Chassis #1 D1100650

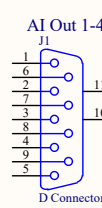

Generic D-Sub 9 Cable M-F

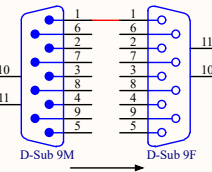

Generic D-Sub 15 Cable M-F

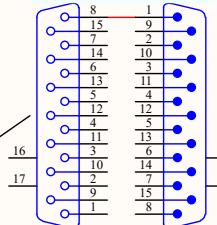

AA Chassis #2 D1100621

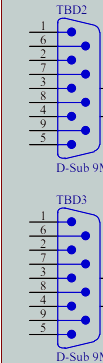
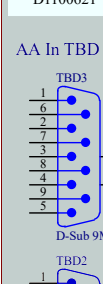

Generic D-Sub 9 Cable M-F

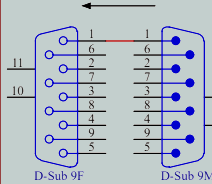
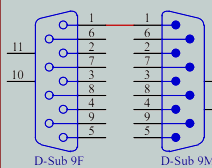
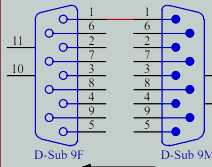

Low Power Coil Driver #1

Coil Current Request Inputs

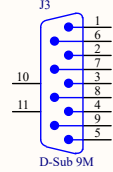

Coil Drive Outputs

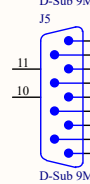
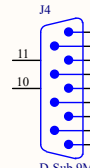
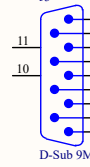
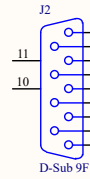
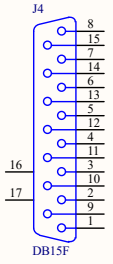

DIO Input

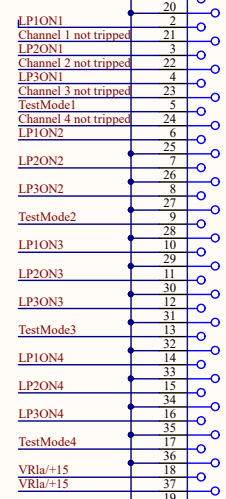

Noise Monitor Input

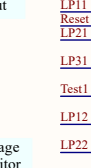

Voltage Monitor Outputs



Fast Current Monitor Outputs

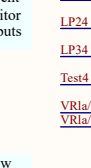

Slow Current Monitor Outputs

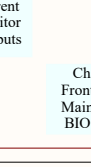

Chassis: JGW-D1503506,
Front Panel: JGW-D1503508,
Main Board: JGW-D1503507
BIO Board: JGW-D1504332

DIO Card #1

Contec DIO-6464L-PE

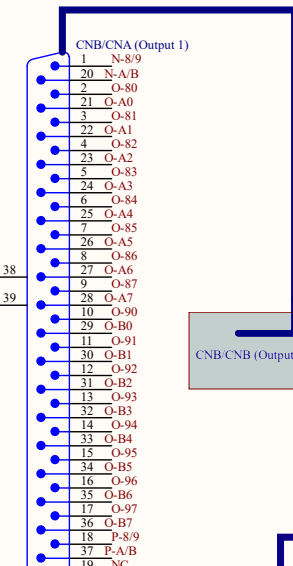
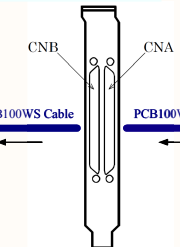

Gender Bender F-F 37 pin

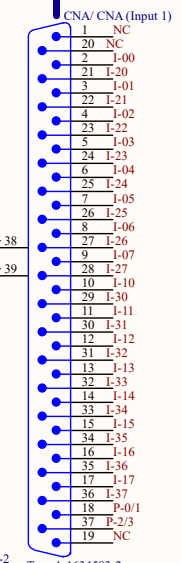
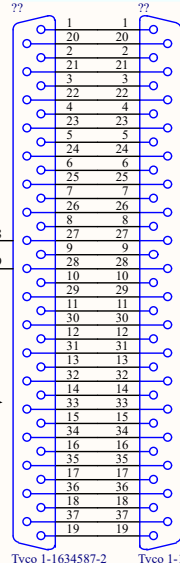

| | | |
|---|------------------------|------------------|
| Title BS Suspension Cabling - OSEM Sat Amps & Drivers - OP | | |
| Size A3 | Number JGW-D1503600 | Revision -v11 |
| Date 2016/11/01 | Sheet 9 of 16 | |
| File: \\.\09 Sat Amps & Coil Drivers OP.SchDoc | | |

OSEM Sat Amp and Driver - IM 1

Sat Amp #2

Chassis: JGW-D1503498,
Front Panel: JGW-D1503500,
Rear Panel: JGW-D1503500,
Board: JGW-D1503499

Inputs from IM-OSEMs
(see Sheet 2)

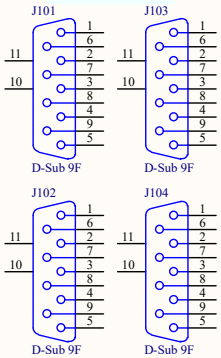

Coil Drive Inputs

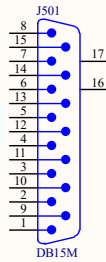

PD Outputs

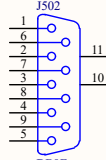

LED Current Monitor Outputs

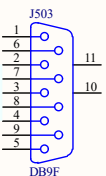

AI Chassis #1 D1100650

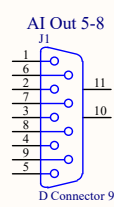

Generic D-Sub 9 Cable M-F

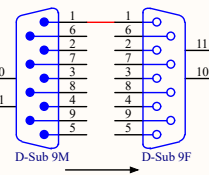

Generic D-Sub 15 Cable M-F

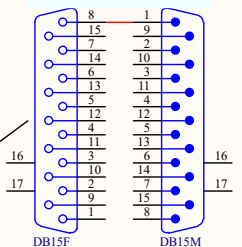

AA Chassis #2 D1100621

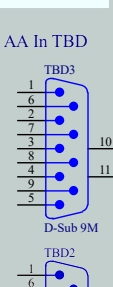

AA In TBD (TBD2)

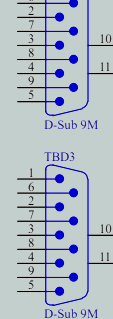

AA In TBD (TBD3)



Low Power Coil Driver #2

Coil Current Request Inputs

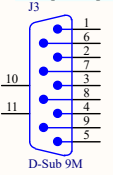

Coil Drive Outputs

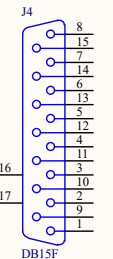

Noise Monitor Input

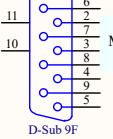

Voltage Monitor Outputs

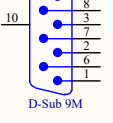

Fast Current Monitor Outputs

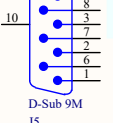

Slow Current Monitor Outputs

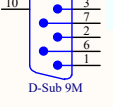

DIO Input

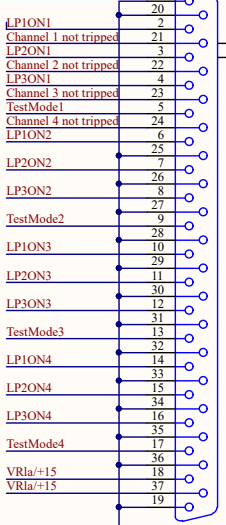

DIO Output

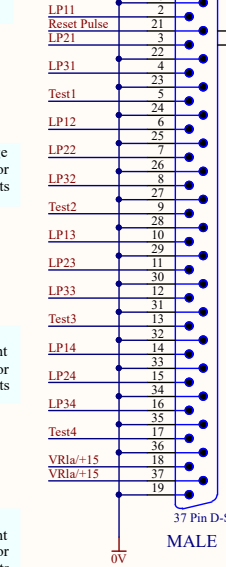

Chassis: JGW-D1503506,
Front Panel: JGW-D1503508,
Main Board: JGW-D1503507
BIO Board: JGW-D1504332

DIO Card #2

Contec DIO-6464L-PE

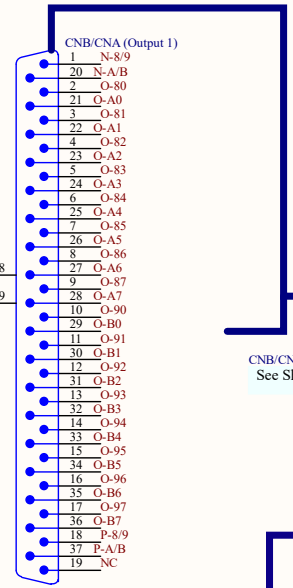
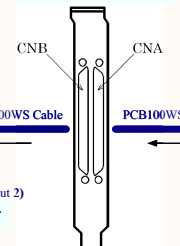

Gender Bender F-F 37 pin

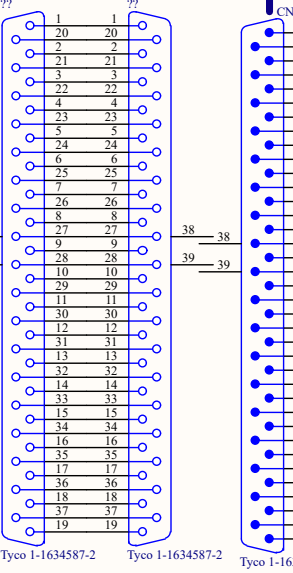

| | | | |
|--|---|-------------|------|
| Title | | | |
| BS Suspension Cabling - OSEM Sat Amps & Drivers - IM 1 | | | |
| Size | Number | Revision | |
| A3 | JGW-D1503600 | 10 | -v11 |
| Date: | 2016/11/01 | Sheet of 16 | |
| File: | \\.\10 Sat Amps & Coil Drivers IM 1.Sch | Drawn By: | |

OSEM Sat Amp and Driver - IM 2

Sat Amp #3

Chassis: JGW-D1503498,
Front Panel: JGW-D1503500,
Rear Panel: JGW-D1503500,
Board: JGW-D1503499

Inputs from IM OSEMs (see Sheet 2)

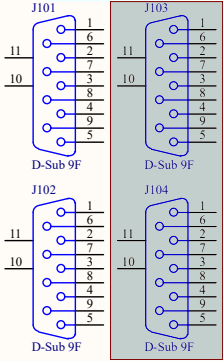

Coil Drive Inputs

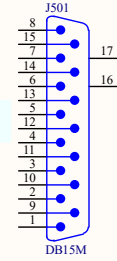

PD Outputs

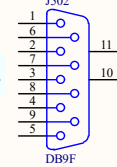

LED Current Monitor Outputs

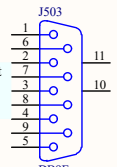

AI Chassis #1 D1100650

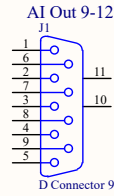

Generic D-Sub 9 Cable M-F

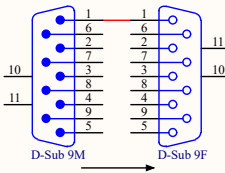

Generic D-Sub 15 Cable M-F

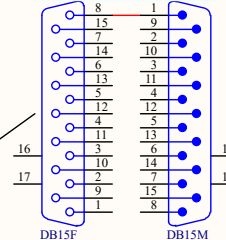

AA Chassis #2 D1100621

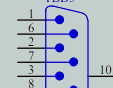
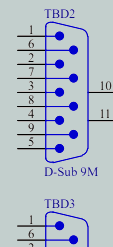
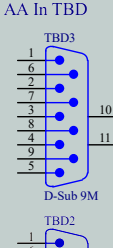

Generic D-Sub 9 Cable M-F

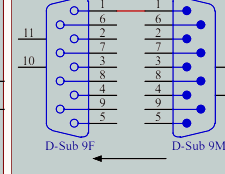
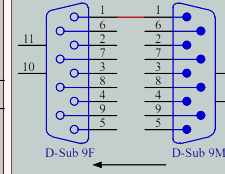
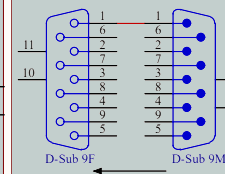

Low Power Coil Driver #3

Coil Current Request Inputs

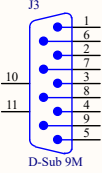

Coil Drive Outputs

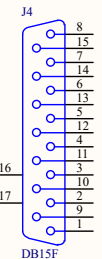

Noise Monitor Input

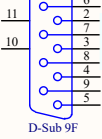

Voltage Monitor Outputs

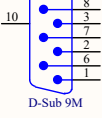

Fast Current Monitor Outputs

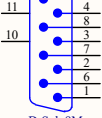

Slow Current Monitor Outputs

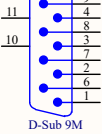

DIO Input

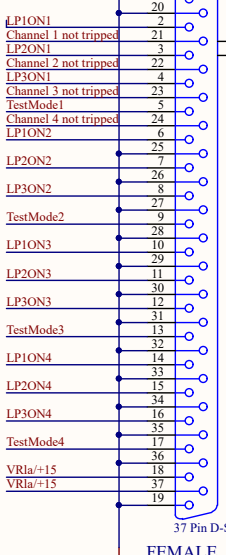

DIO Output

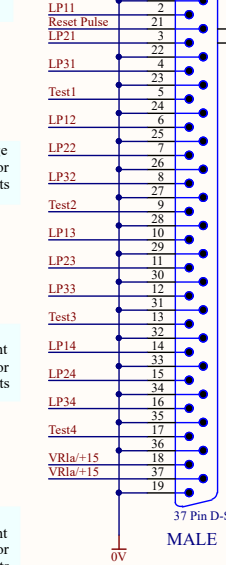

Chassis: JGW-D1503506,
Front Panel: JGW-D1503508,
Main Board: JGW-D1503507
BIO Board: JGW-D1504332

(DIO Card #2)

Contec DIO-6464L-PE

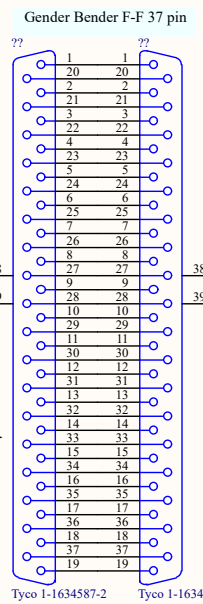
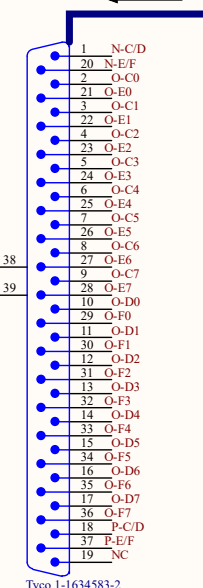
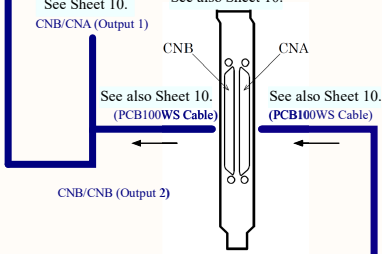

| | | | |
|--|---|-------------|------|
| Title | | | |
| BS Suspension Cabling - OSEM Sat Amps & Drivers - IM 2 | | | |
| Size | Number | Revision | |
| A3 | JGW-D1503600 | 11 | -v11 |
| Date: | 2016/11/01 | Sheet of 16 | |
| File: | \\..11 Sat Amps & Coil Drivers IM 2.Sch | Drawn By: | |

BS&F1 LVDT Drivers

Inputs from BS&F1 LVDTs
(see Sheet 5)

LVDT/ACT Distributor - see also Sheet 13
Chassis: JGW-D1402124
Front Panel: JGW-D1402827
Rear Panel: JGW-D1402828
Board: JGW-D1402117

Ch 0-3 LVDT-IN

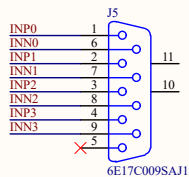

6E17C009SAJ120

Ch 0

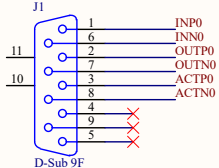

D-Sub 9F

Ch 0-3 LVDT-OUT

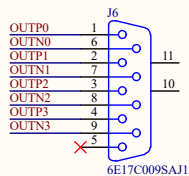

6E17C009SAJ120

Ch 1

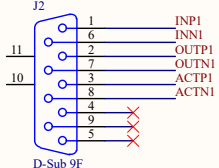

D-Sub 9F

Ch 0-3 ACT

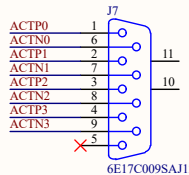

6E17C009SAJ120

2 inputs unused

Ch 2
Ch 3

Generic D-Sub 9 Cable M-F

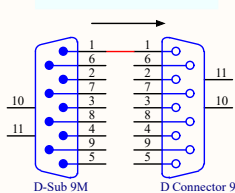

Generic D-Sub 9 Cable M-F

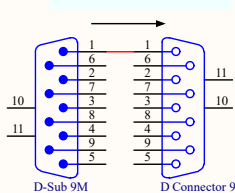

LVDT-Coil Driver Cable

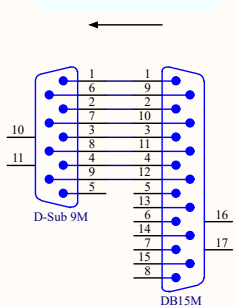

LVDT Driver - see also Sheet 13
Chassis: JGW-D1402826,
Main Board: JGW-D1301467
Input Boards (2): JGW-D1301467
Front Panel: JGW-D1402827

LVDT CARD 1 (Left)

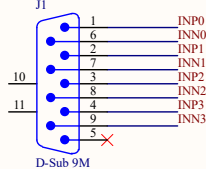

D-Sub 9M

LVDT MAIN (Left)

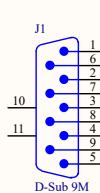

D-Sub 9M

LVDT CARD 1 (Right)

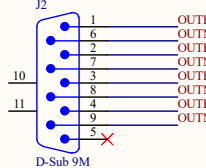

D-Sub 9M

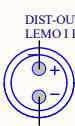

Gender Bender F-F

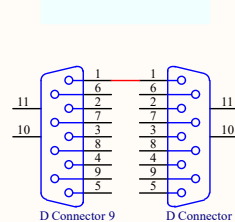

Generic D-Sub 9 Cable M-F

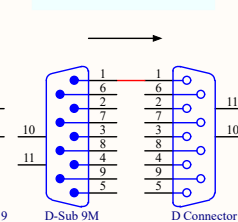

AA Chassis #1
JGW-D1100621

AA In 12-15

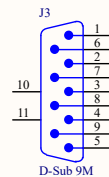

D-Sub 9M

The LVDT Chassis has provision for an oscillator card, but until such time as the cards are available, an external oscillator will be required

Signal Generator
10 kHz, 5 V

Cable

BNC

High Power Coil Driver #1
Chassis: JGW-D1503504
Front Panel: JGW-D1503502
Rear Panel: JGW-D1503505,
Monitor Board: JGW-D1503510

PR3-HPCD-J4

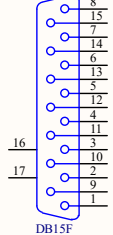

DB15F

PR3-HPCD-J3

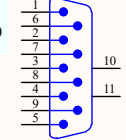

D-Sub 9M

Generic D-Sub 9 Cable M-F

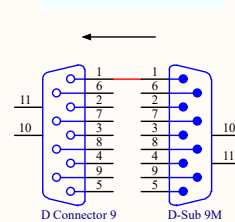

AI Chassis #2
D1101521

AI Out 1-4

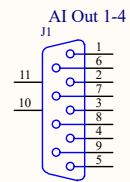

D Connector 9

| | | |
|---|------------------------|------------------|
| Title BS Suspension Cabling - BS&F1 LVDT Drivers | | |
| Size A3 | Number JGW-D1503600 | Revision -v11 |
| Date: 2016/11/01 | Sheet 12 | of 16 |
| File: \\...12 BS&F1 LVDT Drive.SchDoc | Drawn By: | |

**Inputs from F0
LVDTs
(see Sheet 6)**

(LVDT/ACT Distributor - see Sheet 12)
Chassis: JGW-D1402124,
Front Panel: JGW-D1402827
Rear Panel: JGW-D1402828,
Board: JGW-D1402117 #1

Front Panel

Rear Panel

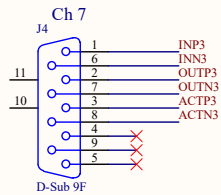
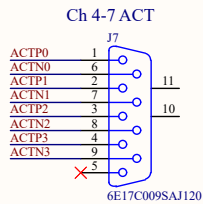
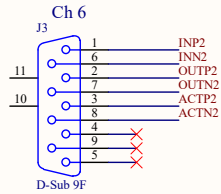
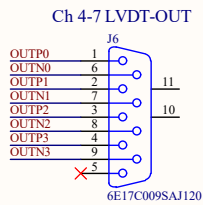
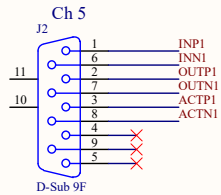
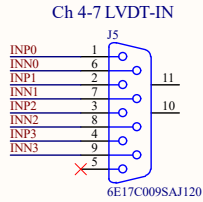
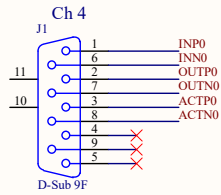

F0 LVDT Drivers

(LVDT Driver - see Sheet 12)
Chassis: JGW-D1402826,
Main Board: JGW-D1301467
Input Boards (2): JGW-D1301467
Front Panel: JGW-D1402827

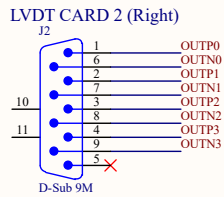
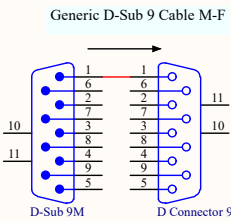
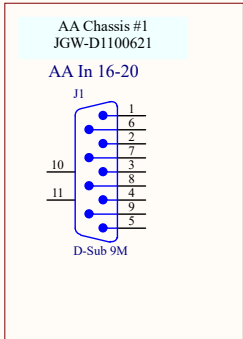
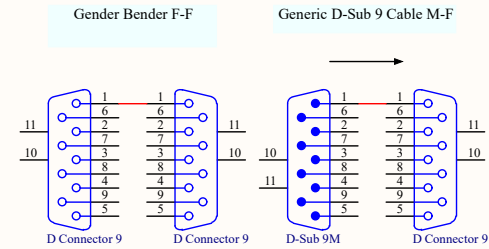
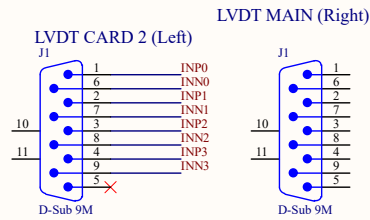
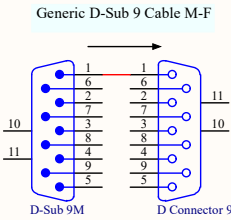

LVDT-Coil Driver Cable

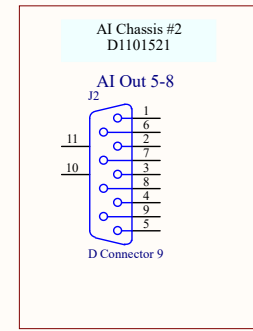
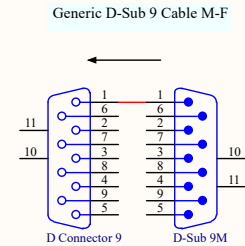
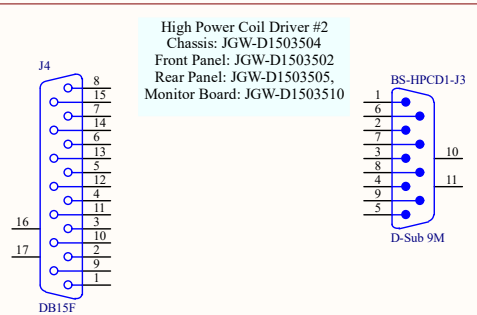
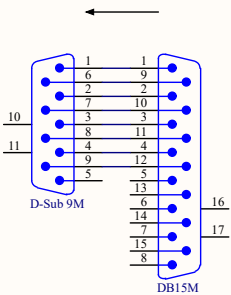

| | | | | | |
|-------|-----------------------------|-----------|--|----|--|
| Title | | | BS Suspension Cabling - F0LVDT Drivers | | |
| Size | Number | Revision | | | |
| A3 | JGW-D1503600 | 13 | -v11 | | |
| Date: | 2016/11/01 | Sheet of | | 16 | |
| File: | \\.\13 F0 LVDT Drive.SchDoc | Drawn By: | | | |

Pico and Stepper Drivers

Stepper Driver #2
 Chassis: JGW-D1605365
 Board: TMCM-6110
 Serial: MOXA NPort 5100A

**BOX STILL IN DESIGN!!!
 GUESS AT FINAL PINOUT!!!**

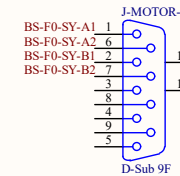
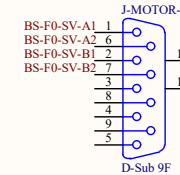

NOTE: 3 channels use switches

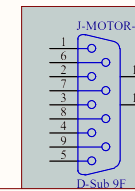
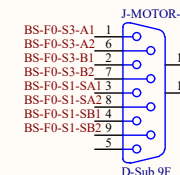
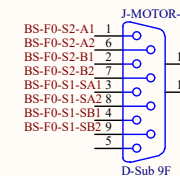
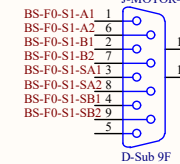

Outputs to F0 Steppers
 (see Sheet 7)

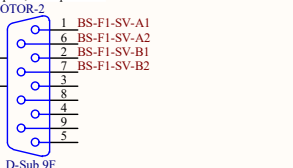
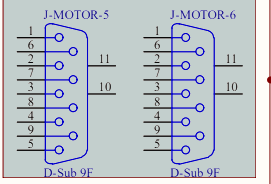
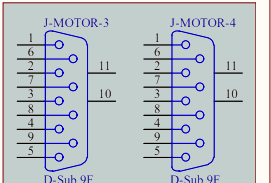
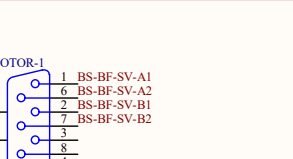
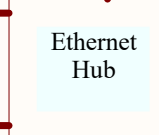
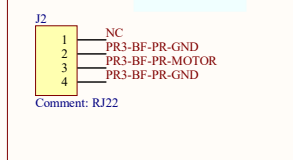
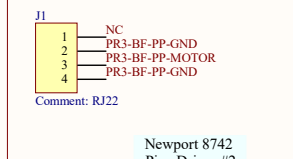
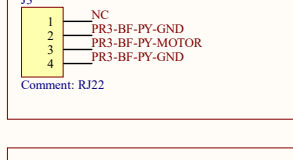
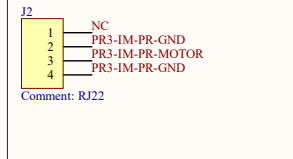
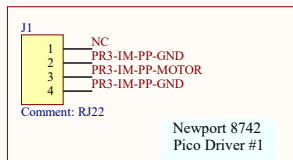

Outputs to IM Picos
 (see Sheet 3)

AC

The connectors for the pico drivers are RJ22 with four pins. I couldn't find Altium versions, so I used a random four-pin connector.

Outputs to BF Picos
 (see Sheet 4)

AC

Output to BF Stepper
 (see Sheet 4)

Output to F1 Stepper
 (see Sheet 4)

| | | | | | |
|-------|----------------------------------|-----------|--|--|----|
| Title | | | BS Suspension Cabling - Pico and Stepper Drivers | | |
| Size | Number | Revision | | | |
| A3 | JGW-D1503600 | 14 | -v11 | | |
| Date: | 2016/11/01 | Sheet | of | | 16 |
| File: | \\.\14 Pico&Stepper Drive.SchDoc | Drawn By: | | | |

3 Feedthroughs

Geophone Readout

Inputs from F0 Geophones (see Sheet 8)

Geophone Distributor
D1402120
Front Panel
D1402122
Board
D1402121

Geophone Distributor
D1402120
Rear Panel
D1402123
Board
D1402121

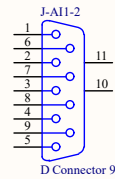
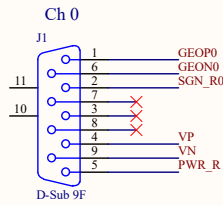

Generic D-Sub 9 Cable M-F

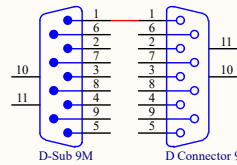

AA Chassis #1
JGW-D1100621

AA In 21-24

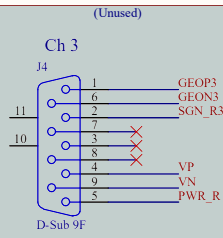
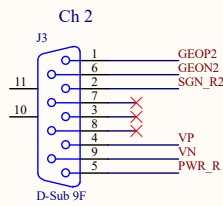
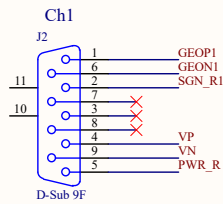
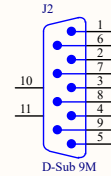

| | | | | | |
|-------|--------------------------------|-----------|--|----|--|
| Title | | | BS Suspension Cabling - Geophone Readout | | |
| Size | Number | Revision | | | |
| A3 | JGW-D1503600 | 15 | -v11 | | |
| Date: | 2016/11/01 | Sheet | of | 16 | |
| File: | \\.\15 Geophone Readout.SchDoc | Drawn By: | | | |

OpLev Etc

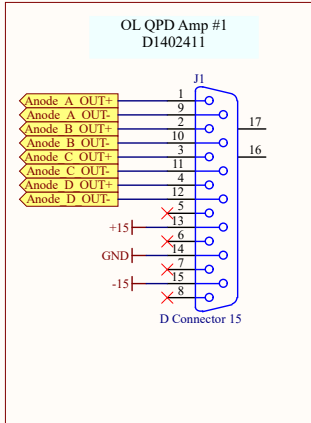

Generic D-Sub 15 Cable M-F

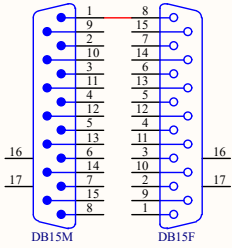

Generic D-Sub 15 Cable M-F

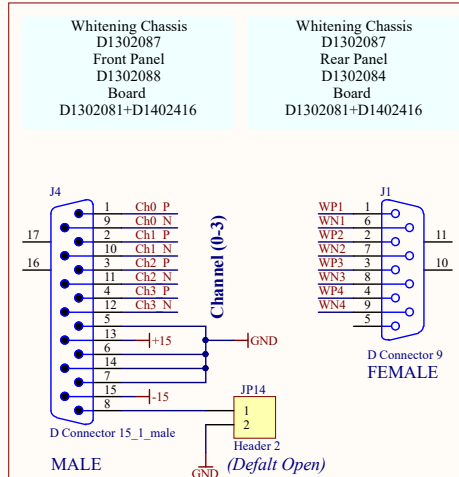
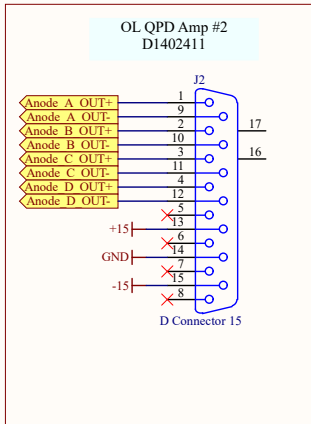
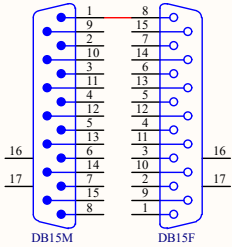

Generic D-Sub 9 Cable M-F

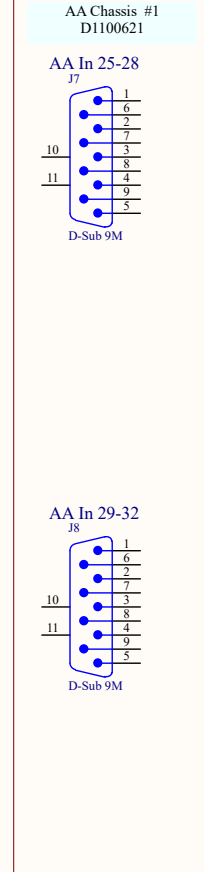
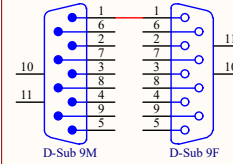

Generic D-Sub 9 Cable M-F

