

4 Feedthroughs

TM OSEMs

Incorporates flip to correct flexicircuit issue!!!

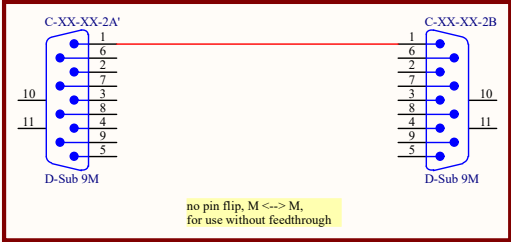
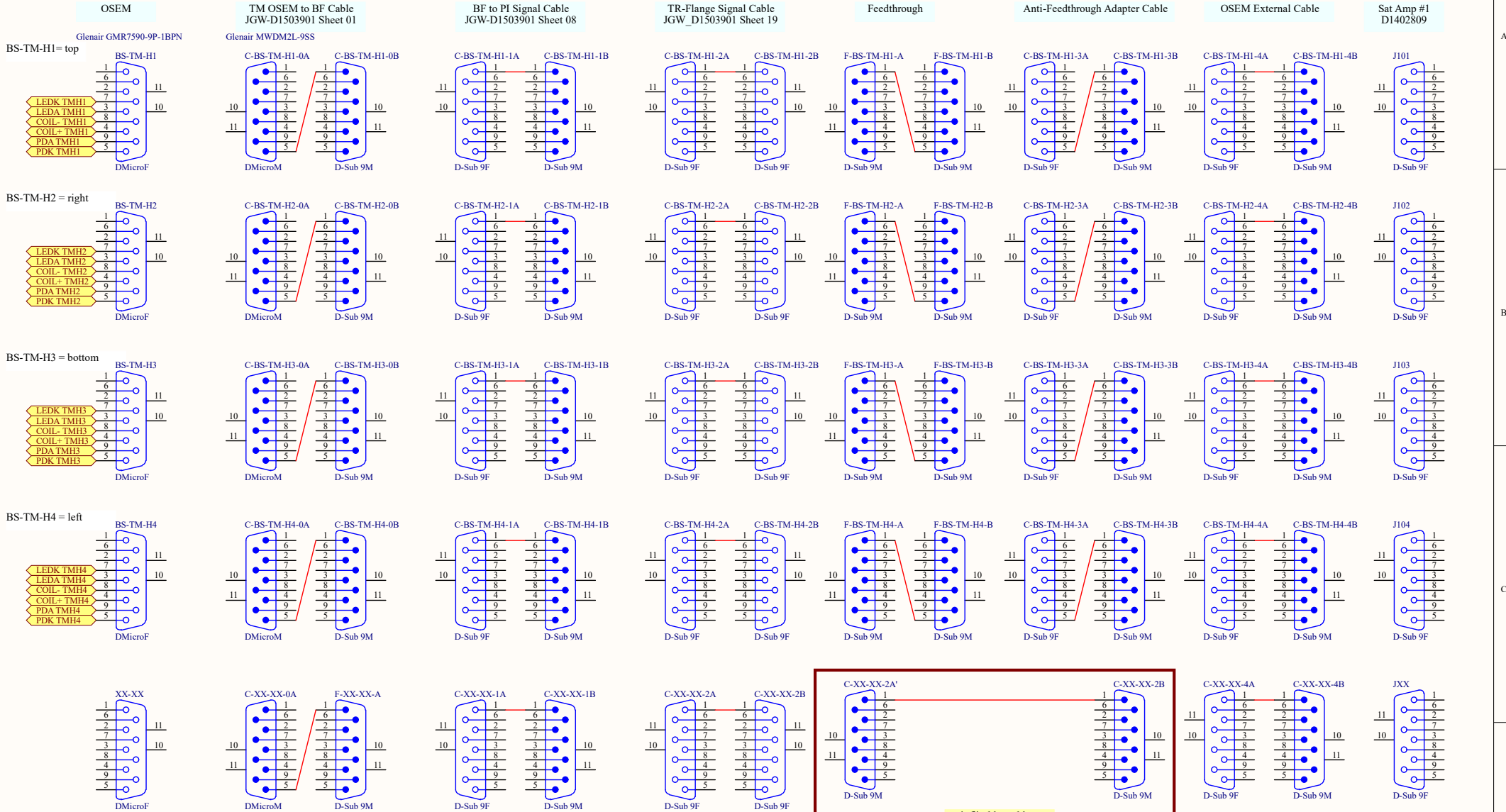

For testing the suspension outside the vacuum tank, there should be a supply of plain M-M gender changers to replace the combination of Feedthrough+Anti-Feedthrough adapter cable.

Title BS Suspension Cabling - Test Mass OSEMs		
Size A3	Number JGW-D1503600	Revision -v10
Date: 2016/06/16	Sheet 1 of 14	
File: \\..01 TM OSEMs.SchDoc	Drawn By:	

6 Feedthroughs

IM OSEMs

Incorporates flip to correct flexicircuit issue!!!
IM OSEM to BF Cable
JGW-D1503901 Sheet 02

OSEM

BF to PI Signal Cable
JGW-D1503901 Sheet 08

TR-Flange Signal Cable
JGW-D1503901 Sheet 19

Feedthrough

Anti-Feedthrough Adapter Cable

OSEM External Cable

Sat Amp #2
D1402809

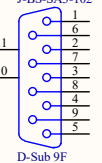
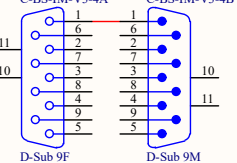
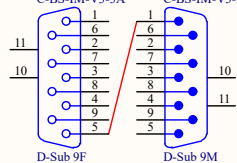
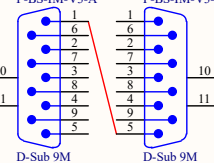
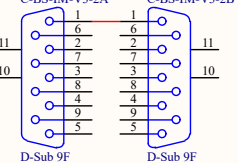
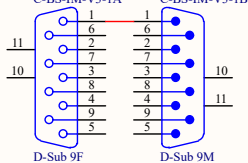
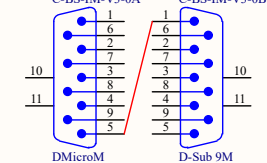
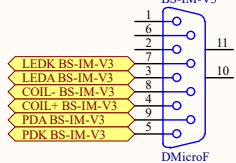
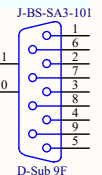
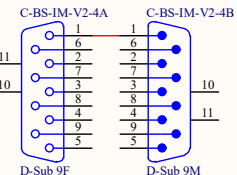
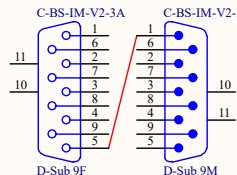
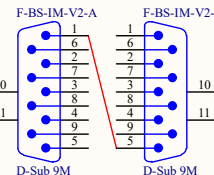
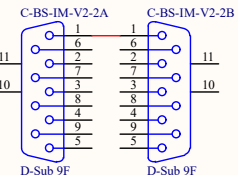
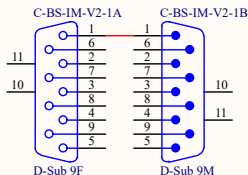
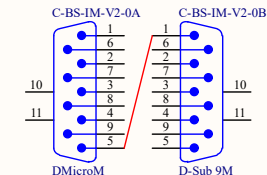
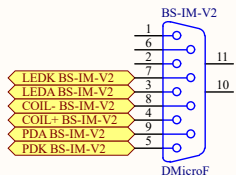
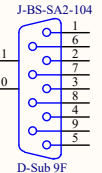
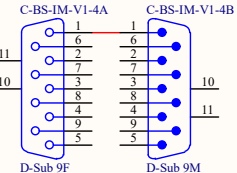
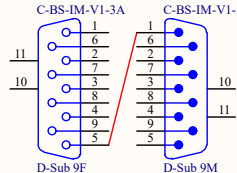
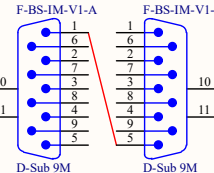
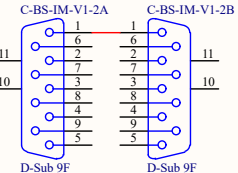
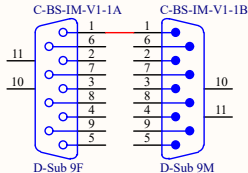
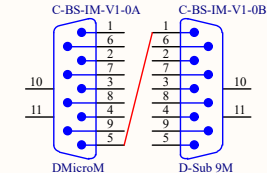
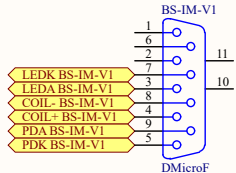
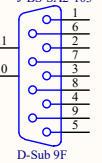
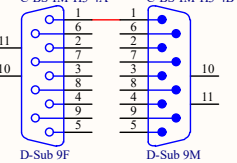
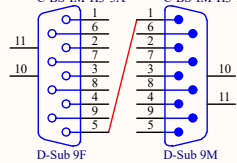
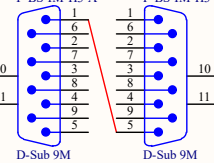
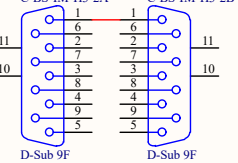
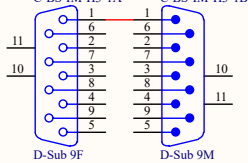
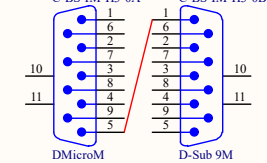
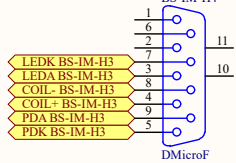
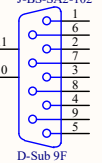
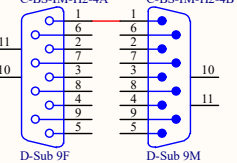
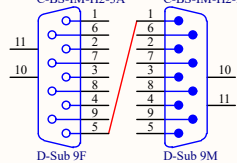
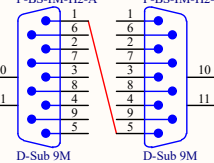
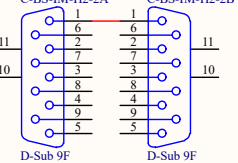
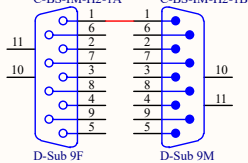
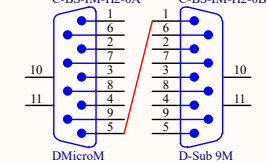
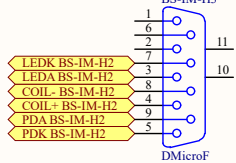
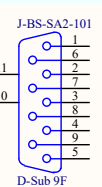
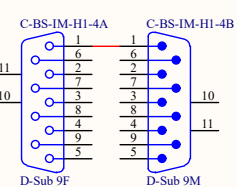
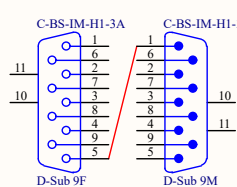
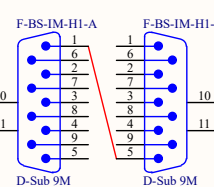
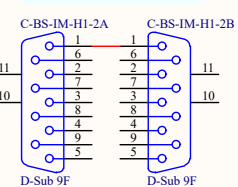
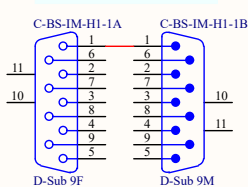
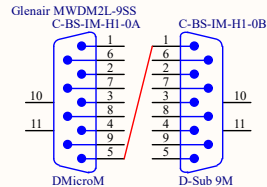
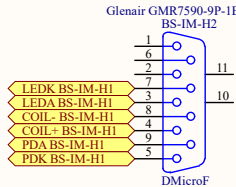

J-BS-SA3-103 and J-BS-SA3-104 not used

Title BS Suspension Cabling - Intermediate Mass OSEMs		
Size A3	Number JGW-D1503600	Revision -v10
Date 2016/06/16	Sheet 7 of 14	
File \\..02 IM OSEMs.SchDoc	Drawn By:	

1 Feedthrough

IM Picomotors

In -v10, the BS Yaw Pico was moved to the IM sheet and grouped with the IM picos, because it's more physically convenient for wiring and more logical (it actually rotates the IM).

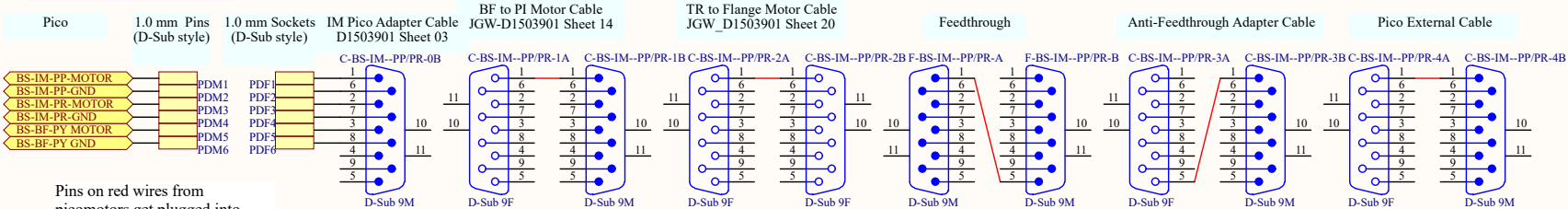

Pins on red wires from picomotors get plugged into sockets from pins 1, 2, 3.

Pins on white wires from picomotors get plugged into sockets from pins 6, 7, 8.

The pico motor at the bottom level of the IM does pitch and gets plugged into 1&6.

The pico motor at the top level of the IM does roll and gets plugged into 2&7.

The pico motor in the BS does IM yaw and gets plugged into 3&8.

The connectors for the pico drivers are RJ22 with four pins. I couldn't find Altium versions, so I used a random four-pin connector.

The adapter cable is made by combining the cables supplied by the pico manufacturer (Newport) with a D-Sub 9 female.

Green wires from manufacturer's cables get soldered to pins 1, 2.

Yellow wires from manufacturer's cables get soldered to pins 6, 7.

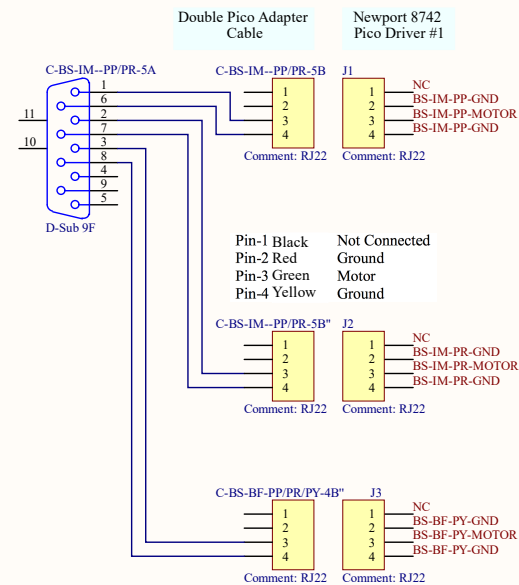

Title BS Suspension Cabling - Intermediate Mass Picos			
Size A3	Number JGW-D1503600	Revision -v10	
Date: 2016/06/16	Sheet: 3 of 14	Revision	
File: \\...03 IM Picos.SchDoc	Drawn By:		

3 Feedthroughs

In -v10, the BS Yaw Pico was moved to the IM sheet and grouped with the IM picos, because it's more physically convenient for wiring and more logical (it actually rotates the IM).

BF and SF Picomotors and Steppers

The connectors for the pico drivers are RJ22 with four pins. I couldn't find Altium versions, so I used a random four-pin connector.

Pin-1 Black Not Connected
Pin-2 Red Ground
Pin-3 Green Motor
Pin-4 Yellow Ground

Picos 1.0 mm Pins (D-Sub style) 1.0 mm Sockets (D-Sub style) BF Pico Adapter Cable D1503901 Sheet 04

BF to PI Motor Cable JGW-D1503901 Sheet 14

TR to Flange Motor Cable JGW-D1503901 Sheet 20

Feedthrough

Anti-Feedthrough Adapter Cable

Pico External Cable

Pico Adapter Cable

Newport 8742 Pico Driver #2

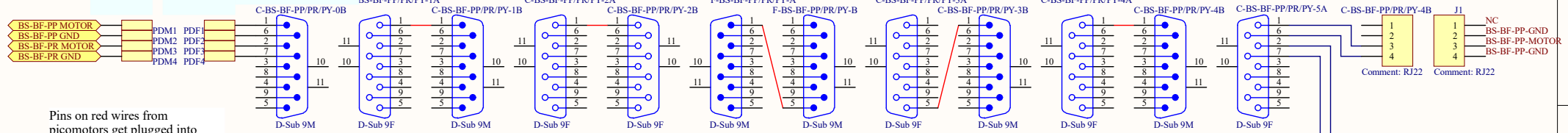

Pins on red wires from picomotors get plugged into sockets from pins 1, 2.

Pins on white wires from picomotors get plugged into sockets from pins 6, 7.

The adapter cable is made by combining the cables supplied by the pico manufacturer (Newport) with a D-Sub 9 female.

Green wires from manufacturer's cables get soldered to pins 1, 2, 3.

Yellow wires from manufacturer's cables get soldered to pins 6, 7, 8.

Steppers 1.6 mm Sockets (Burndy) 1.6 mm Pins (Burndy) BF&SF Stepper Adapter Cable D1503901 Sheet 05

BF to PI Motor Cable JGW-D1503901 Sheet 14

SUS to Flange Motor Cable JGW-D1503901 Sheet 20

Feedthrough

Anti-Feedthrough Adapter Cable

Stepper External Cable

Stepper Adapter Cable

Stepper Driver #1 JGW-D1600TBD Board TMCM-6110 Serial-Internet Converter MOXA

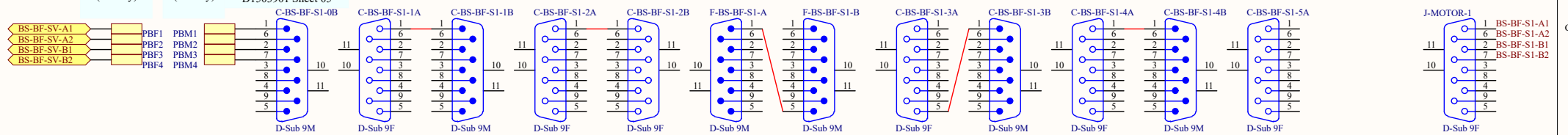

SF to PI Motor Cable JGW-D1503901 Sheet 15

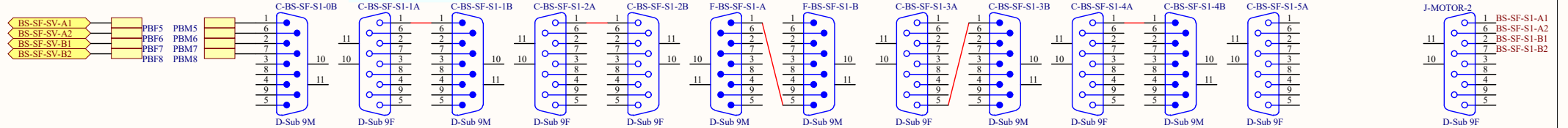

Title			
BS Suspension Cabling - Bottom and Standard Filter Picos/Steppers			
Size	Number	Revision	
A3	JGW-D1503600	-v10	
Date:	2016/06/16	Sheet 4 of 14	
File:	\\.\04 BF&SF Picos&Steppers.SchDoc	Drawn By:	

BF and SF LVDT/ACTs

2 Feedthroughs

LVDT/ACT Distributor
JGW-D1402124,
Front Panel
JGW-D1402827
Board
JGW-D1402117 #2

LVDT/Act

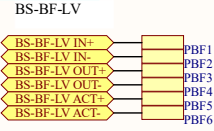

BF&SF LVDT Adapter Cable
JGW-D1503901 Sheet 06

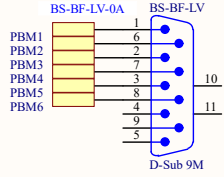

BF-PI Signal Cable
JGW-D1503901 Sheet 08

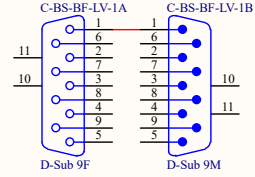

TR-Flange Signal Cable
JGW_D1503901 Sheet 19

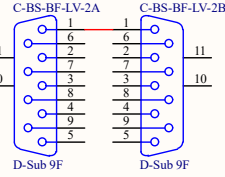

Feedthrough

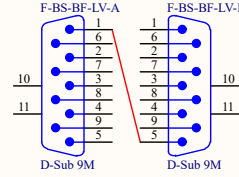

Feedthrough Adapter Cable

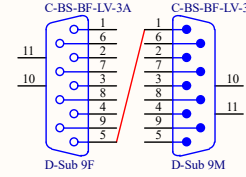

External Cable

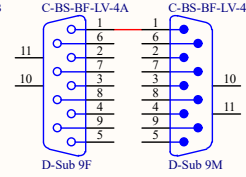

Ch 4

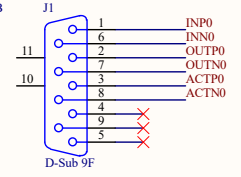

LVDT/Act

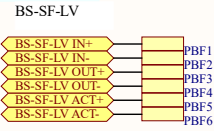

BF&SF LVDT Adapter Cable
JGW-D1503901 Sheet 06

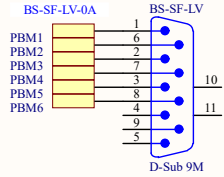

SF-PI Signal Cable
JGW-D1503901 Sheet 09

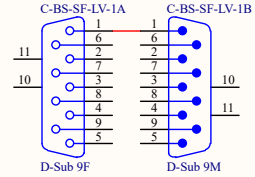

TR-Flange Signal Cable
JGW_D1503901 Sheet 19

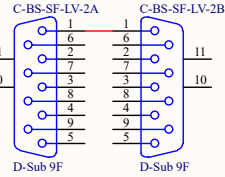

Feedthrough

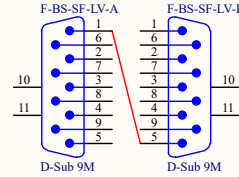

Feedthrough Adapter Cable

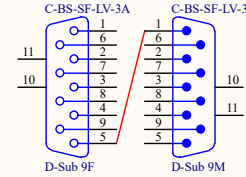

External Cable

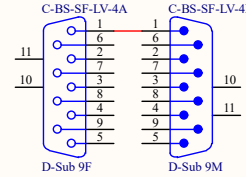

Ch 5

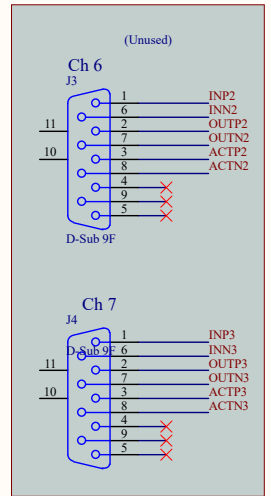
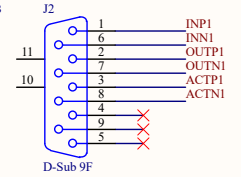

Title			
BS Suspension Cabling - Bottom and Standard Filter LVDTs			
Size	Number	Revision	
A3	JGW-D1503600	-v10	
Date:	2016/06/16	Sheet 5of 14	
File:	\\.\05 BF&SF LVDTs.SchDoc	Drawn By:	

4 Feedthroughs

Preisolator LVDT/ACTs

LVDT/ACT

OPTIONAL
Signal Cable Extension
JGW_D1503901 Sheet 10

TR-Flange Signal Cable
JGW_D1503901 Sheet 19

Feedthrough

Anti-Feedthrough Adapter Cable

LVDT/ACT External Cable

LVDT/ACT Distributor
JGW-D1402124,
Front Panel
JGW-D1402827
Board
JGW-D1402117 #1

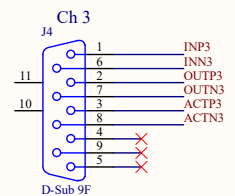
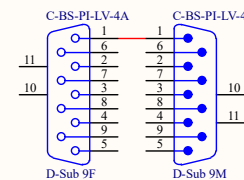
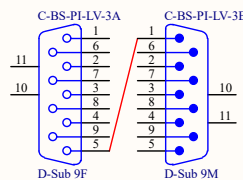
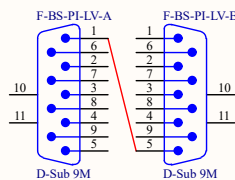
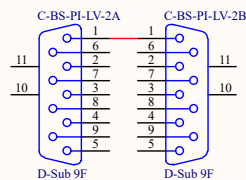
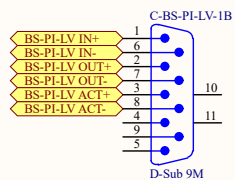
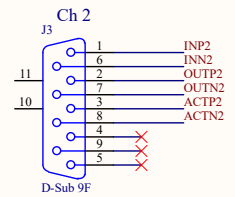
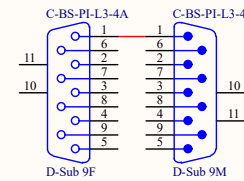
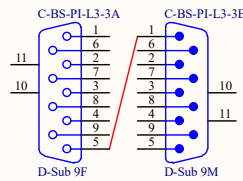
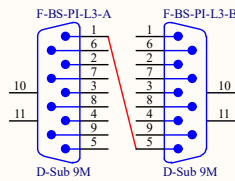
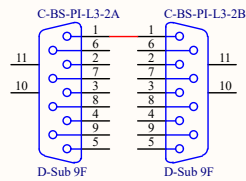
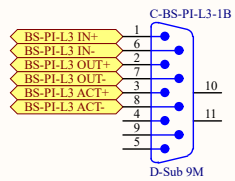
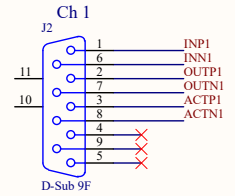
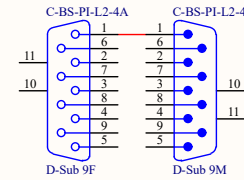
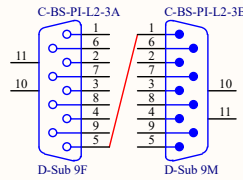
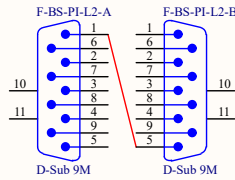
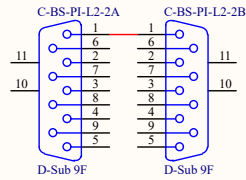
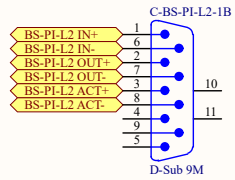
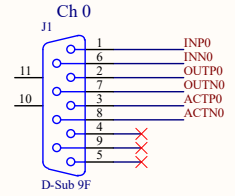
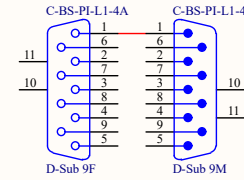
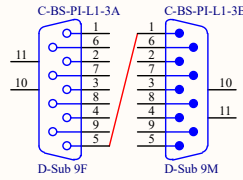
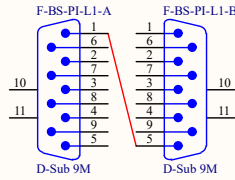
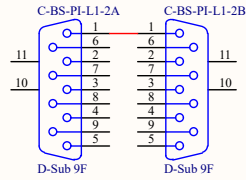
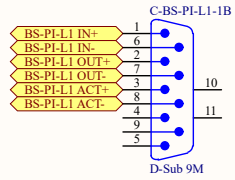

LVDT-COIL

Pin	Function
1	LVDT IN P
2	LVDT OUT P
3	COIL P
4	
5	
6	LVDT IN N
7	LVDT OUT N
8	COIL N
9	

Title		
BS Suspension Cabling - Preisolator LVDT/Actuators		
Size	Number	Revision
A3	JGW-D1503600	-v10
Date:	2016/06/16	Sheet 6of 14
File:	\\.\06 PI LVDTs.SchDoc	Drawn By:

4 Feedthroughs

Preisolator Steppers

TMCM-6110 Stepper Driver #2

Stepper Driver #2
JGW-D1600TBD Board
TMCM-6110
Serial-Internet Converter
MOXA

Stepper

PI Stepper Adapter
JGW-D1503901 Sheet 24

OPTIONAL
Motor Cable Extension
JGW_D1503901 Sheet 36

TR to Flange Motor Cable
JGW-D1503901 Sheet 20

Feedthrough

Anti-Feedthrough Adapter Cable

Stepper External Cable

Stepper Splitter Cable
Double Motor Version

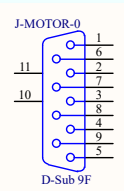
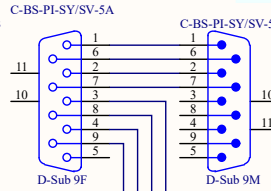
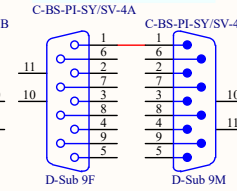
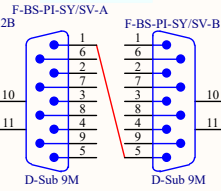
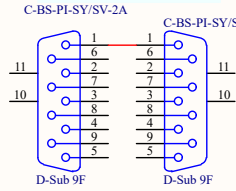
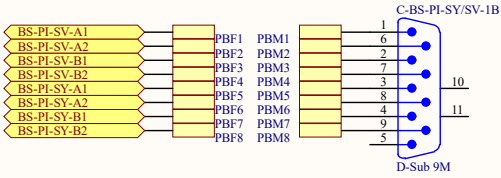

The vertical and yaw steppers have no limit switches and are combined on a single cable that VIS needs to provide.

The horizontal steppers have limit switches and will be wired as indicated by the IP manufacturer.

PI to Flange Motor Cable
JGW-D1503901 Sheet 13

Stepper Splitter Cable
Motor+Switch Version

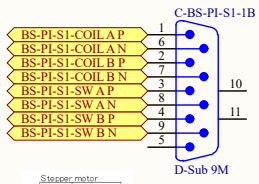

Pin	Function
1	COIL A P
2	COIL B P
3	Switch 1 P
4	Switch 2 P
5	
6	COIL A N
7	COIL B N
8	Switch 1 N
9	Switch 2 N
10	
11	

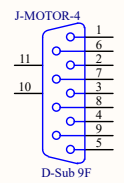
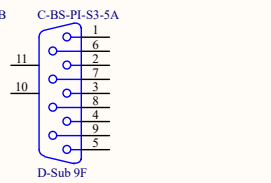
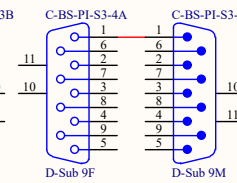
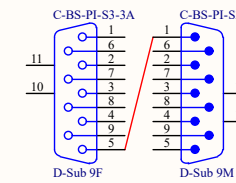
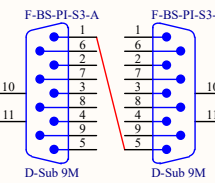
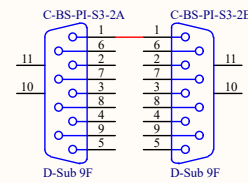
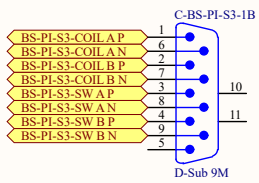
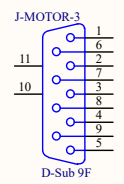
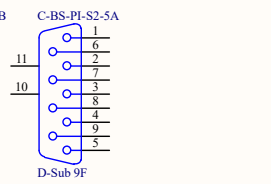
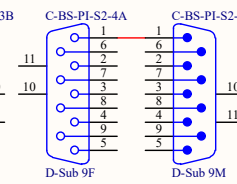
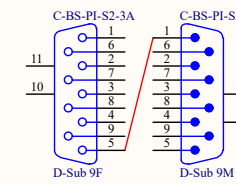
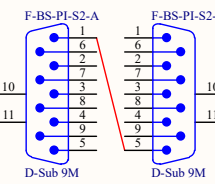
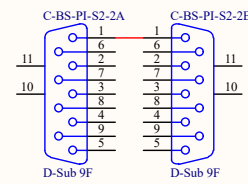
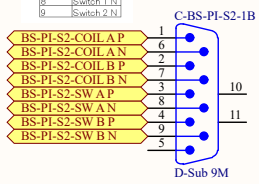
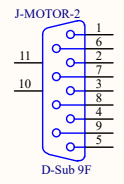
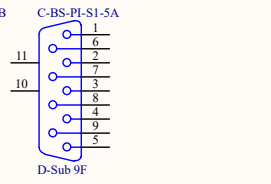
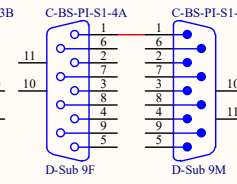
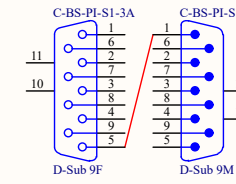
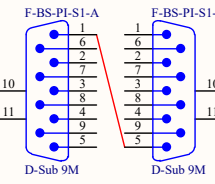
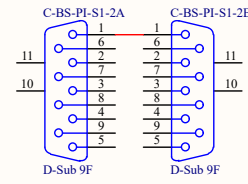

Title BS Suspension Cabling - Preisolator Steppers		
Size A3	Number JGW-D1503600	Revision -v10
Date: 2016/06/16	Sheet 7 of 14	
File: \\..07 PI Steppers.SchDoc	Drawn By:	

3 Feedthroughs

Preisolator Geophones

Geophone Pod Internal Cabling
(same for all three pods):

Pod #1: geophone L400002322, preamp 15
Pod #2: geophone L400002321, preamp 12
Pod #3: geophone L400002323, preamp 14

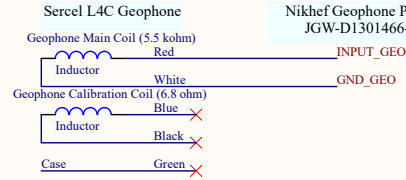

Note: The usual TR to Flange Signal Cable (D1503901 Sheet 19) cannot be used here because it doesn't have a conductor on Pin 5!!!



Geophone Pod

Geophone Adapter Cable
JGW-D1503901 Sheet 07

PI to Flange Geophone Cable
JGW-E1503901 Sheet 12

Feedthrough

Anti-Feedthrough Adapter Cable

Geophone External Cable

Geophone Distributor
JGW-D1402120

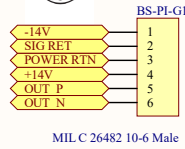

BS-PI-G1
(A) 1
(B) 2
(C) 3
(D) 4
(E) 5
(F) 6

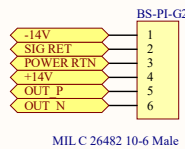
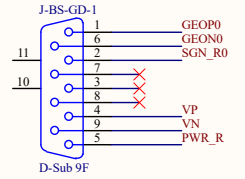
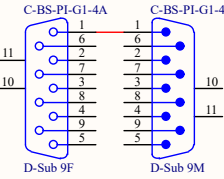
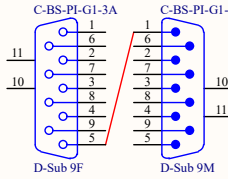
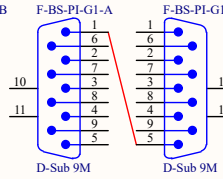
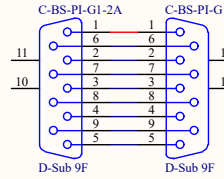
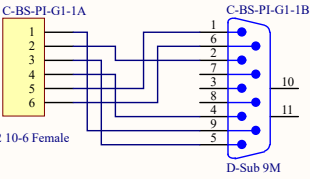

BS-PI-G2
(A) 1
(B) 2
(C) 3
(D) 4
(E) 5
(F) 6

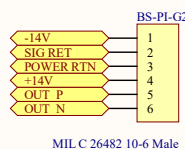
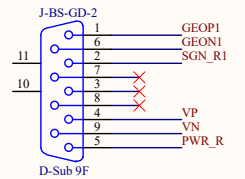
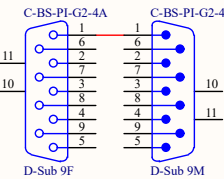
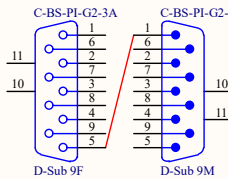
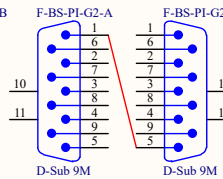
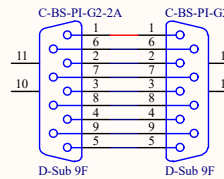
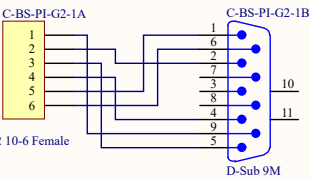

BS-PI-G3
(A) 1
(B) 2
(C) 3
(D) 4
(E) 5
(F) 6

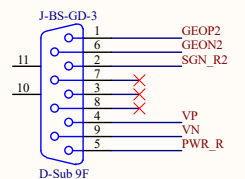
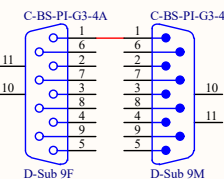
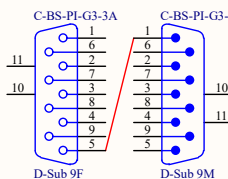
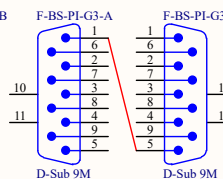
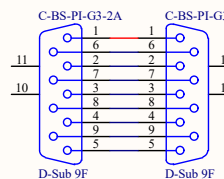
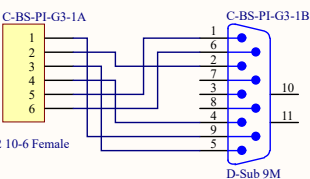

J-BS-GD-4 not used

Title BS Suspension Cabling - Preisolator Geophones		
Size A3	Number JGW-D1503600	Revision -v10
Date: 2016/06/16	Sheet 8 of 14	Drawn By:
File: \\.\08 PI Geophones.SchDoc		

OSEM Sat Amps and Drivers

Sat Amp Inputs from OSEMs (see Sheets 1&2)

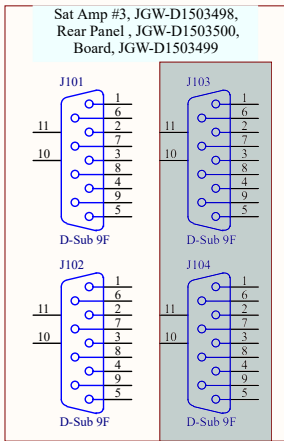
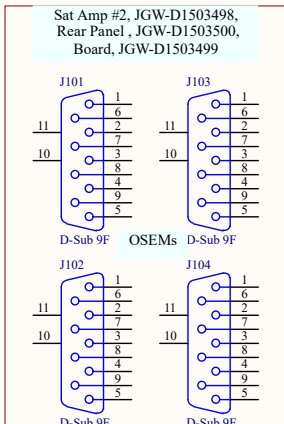
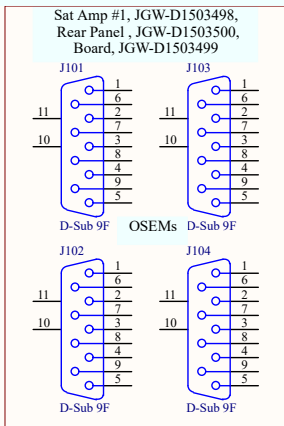

Sat Amp PD Outputs

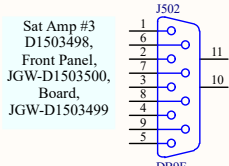
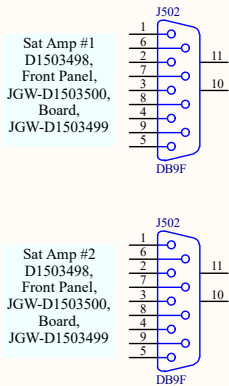

Sat Amp LED Current Monitor Outputs

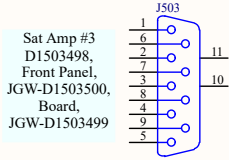
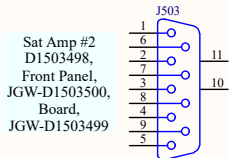
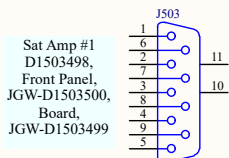

Generic D-Sub 9 Cable M-F

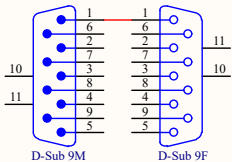
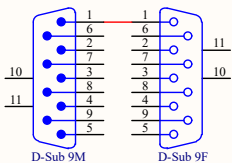
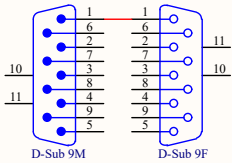

Generic D-Sub 9 Cable M-F

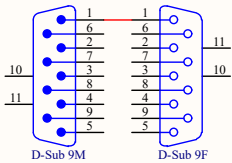
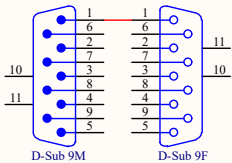
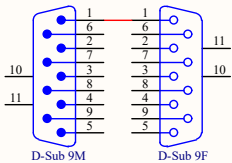

AA Chassis #1 D1100621

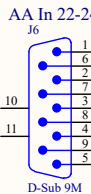
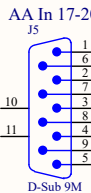
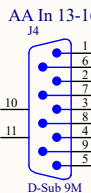

AA In TBD TBD1



AA In TBD TBD2

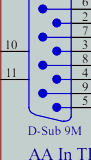

AA In TBD TBD3

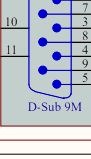

Sat Amp #1
JGW-D1503498,
Front,
JGW-D1503500,
Board,
JGW-D1503499

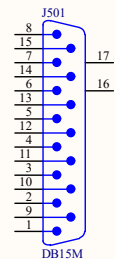

Sat Amp #2
JGW-D1503498,
Front,
JGW-D1503500,
Board,
JGW-D1503499

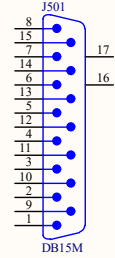

Sat Amp #3
JGW-D1503498,
Front,
JGW-D1503500,
Board,
JGW-D1503499

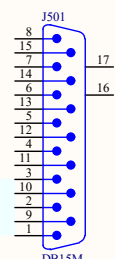

Sat Amp Coil Current Inputs

Low Power Coil Driver #1
JGW-D1503506,
Front Panel,
JGW-D1503508,
Board,
JGW-D1503507

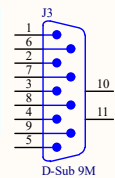

Low Power Coil Driver #2
JGW-D1503506,
Front Panel,
JGW-D1503508,
Board,
JGW-D1503507

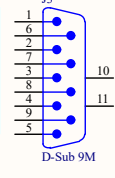

Low Power Coil Driver #3
JGW-D1503506,
Front Panel,
JGW-D1503508,
Board,
JGW-D1503507

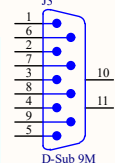

Coil Current Request Inputs

Generic D-Sub 15 Cable M-F

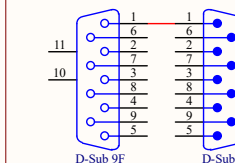
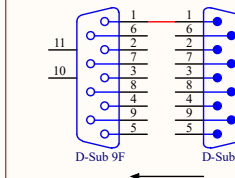
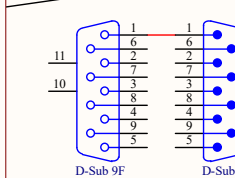
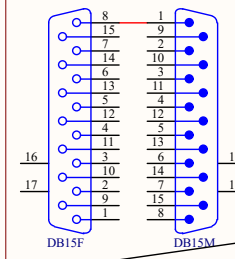
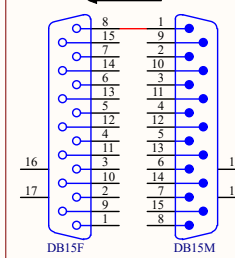
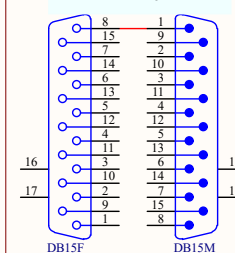

Generic D-Sub 9 Cable M-F

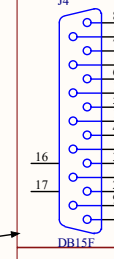
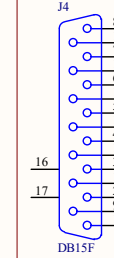
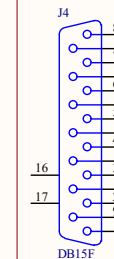

Low Power Coil Driver #1
JGW-D1503506,
Rear Panel,
JGW-D1503509,
Board,
JGW-D1503507

Low Power Coil Driver #2
JGW-D1503506,
Rear Panel,
JGW-D1503509,
Board,
JGW-D1503507

Low Power Coil Driver #3
JGW-D1503506,
Rear Panel,
JGW-D1503509,
Board,
JGW-D1503507

AI Out 1-4

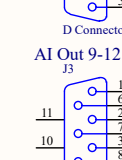
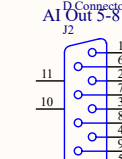
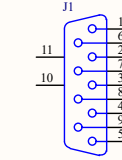

AI Chassis #1
D1101521

Title			BS Suspension Cabling - OSEM Sat Amps & Drivers		
Size	Number	JGW-D1503600		Revision	-v10
A3					
Date:	2016/06/16	Sheet	9 of 14		
File:	\\..09 Sat Amps & Coil Drivers.SchDoc	Drawn By:			

BS&SF LVDT Drivers

**Inputs from
BS&SF
LVDTs
(see Sheet 5)**

LVDT/ACT Distributor
JGW-D1402124,
Rear Panel
JGW-D1402828,
Board
JGW-D1402117 #2

Ch 4-7 LVDT-IN

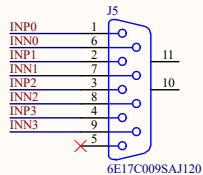

LVDT/ACT Distributor
JGW-D1402124,
Front Panel
JGW-D1402827
Board
JGW-D1402117 #2

Ch 4

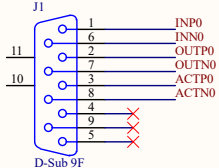

Ch 4-7 LVDT-OUT

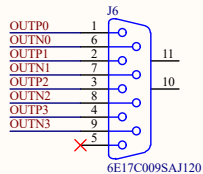

Ch 5

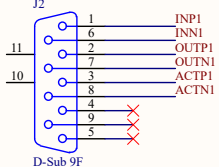

**2 inputs
unused**

Ch 6
Ch 7

Ch 4-7 ACT

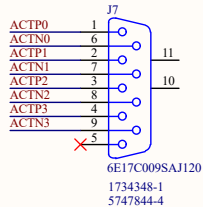

Generic D-Sub 9 Cable M-F

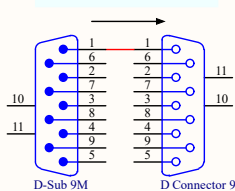

LVDT Driver Chassis
JGW-D1402826,
Front Panel
JGW-D1402827
Input Board #2
JGW-D1301467

LVDT Driver Chassis
JGW-D1402826,
Front Panel
JGW-D1402827
Main Board
JGW-D1301467

LVDT MAIN (Right)

LVDT CARD 2 (Left)

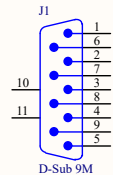
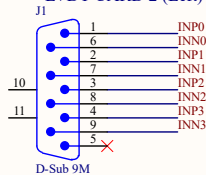

Gender Bender F-F

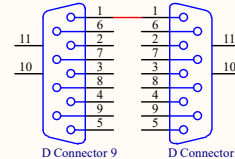

Generic D-Sub 9 Cable M-F

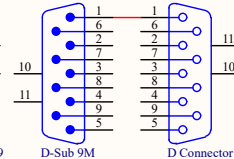

AA Chassis #1
JGW-D1100621

AA In 9-12

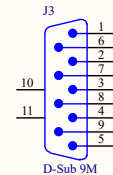

Generic D-Sub 9 Cable M-F

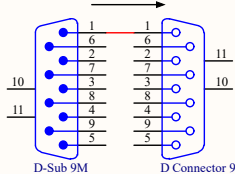

LVDT CARD 2 (Right)

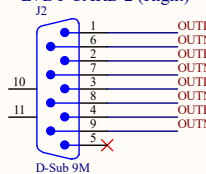

LVDT-Coil Driver Cable

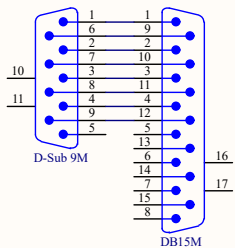

High Power Coil Driver #2
JGW-D1503504,
Rear Panel,
JGW-D1503505,
Monitor Board
JGW-D1503510

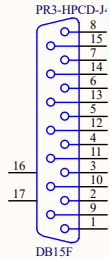

High Power Coil Driver #1
JGW-D1503504,
Front Panel,
JGW-D1503502,
Driver Board
JGW-D1503503

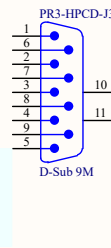

Generic D-Sub 9 Cable M-F

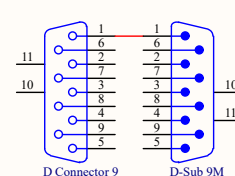

AI Chassis #2
D1101521

AI Out 1-4

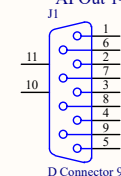

Signal Generator
10 kHz, 5 V

J7

BNC

The LVDT Chassis has provision for an oscillator card, but until such time as the cards are available, an external oscillator will be required

Cable

LVDT Driver Chassis
JGW-D1402826,
Front Panel
JGW-D1402827
Interface Board
JGW-D1402829



DIST-OUT4
LEMO I Pin

Title BS Suspension Cabling - BS&SF LVDT Drivers		
Size A3	Number JGW-D1503600	Revision -v10
Date: 2016/06/16	Sheet of 10	Sheet 14
File: \\.\10 BS&SF LVDT Drive.SchDoc	Drawn By:	

**Inputs from PI LVDTs
(see Sheet 6)**

LVDT/ACT Distributor
JGW-D1402124,
Rear Panel
JGW-D1402828,
Board
JGW-D1402117 #1

LVDT/ACT Distributor
JGW-D1402124,
Front Panel
JGW-D1402827
Board
JGW-D1402117 #1

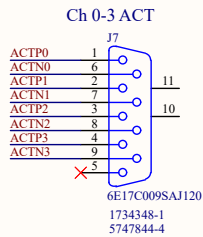
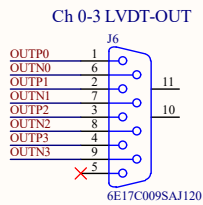
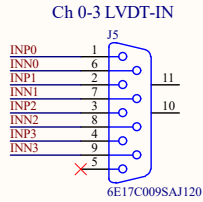
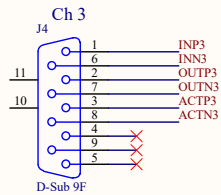
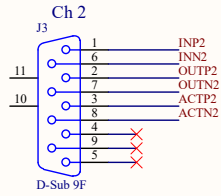
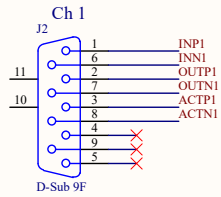
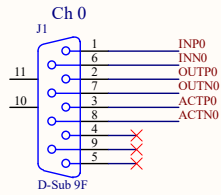

PI LVDT Drivers

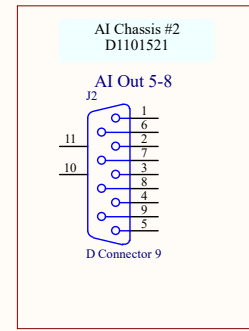
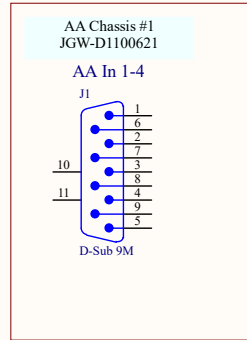
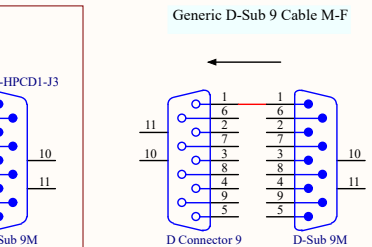
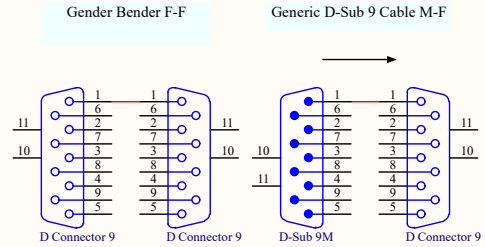
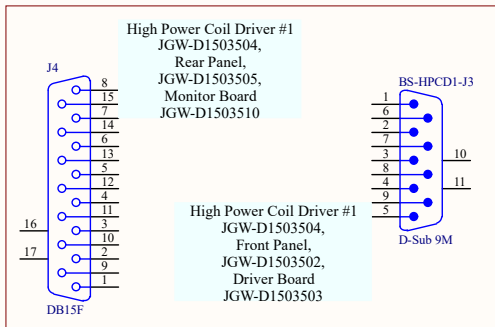
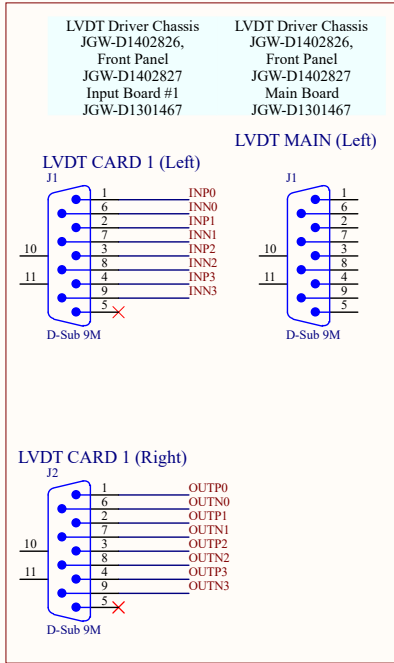
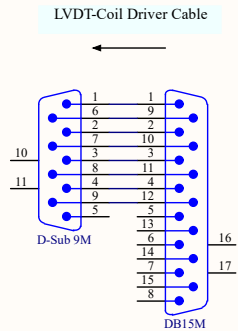
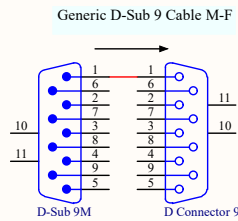
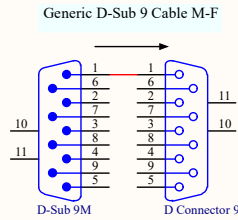

Title		
BS Suspension Cabling - PI LVDT Drivers		
Size	Number	Revision
A3	JGW-D1503600	-v10
Date:	2016/06/16	Sheet of 14
File:	\\M11 PI LVDT Drive.SchDoc	Drawn By:

Pico and Stepper Drivers

Stepper Driver #2
JGW-D1600TBD
Board
TMCM-6110
Serial-Internet Converter
MOXA

**BOX STILL IN DESIGN!!!
GUESS AT FINAL PINOUT!!!**

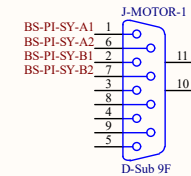
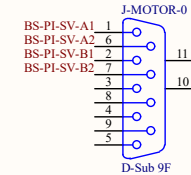

NOTE: 3 channels use switches

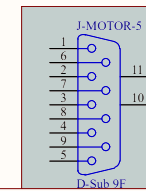
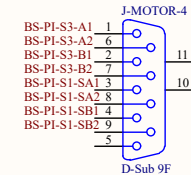
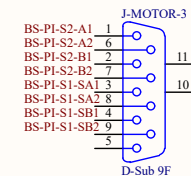
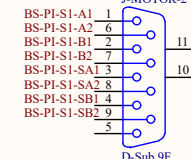

Outputs to PI
Steppers
(see Sheet 7)

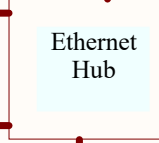
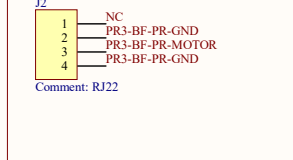
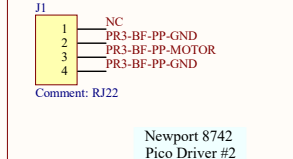
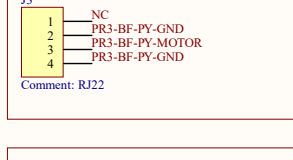
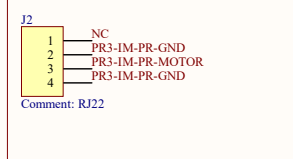
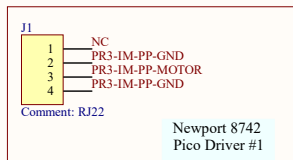

AC

AC

The connectors for the pico drivers are RJ22 with four pins. I couldn't find Altium versions, so I used a random four-pin connector.

Outputs to IM Picos
(see Sheet 3)

Outputs to BF Picos
(see Sheet 4)

Output to BF Stepper
(see Sheet 4)

Output to SF Stepper
(see Sheet 4)

**BOX STILL IN DESIGN!!!
GUESS AT FINAL PINOUT!!!**

Stepper Driver #1
JGW-D1600TBD
Board
TMCM-6110
Serial-Internet Converter
MOXA

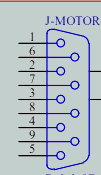
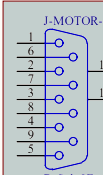
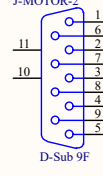
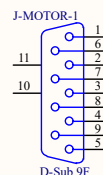

Title BS Suspension Cabling - Pico and Stepper Drivers		
Size A3	Number JGW-D1503600	Revision -v10
Date: 2016/06/16	Sheet of 12	Sheet of 14
File: \\.\12 Pico&Stepper Drive.SchDoc	Drawn By:	

3 Feedthroughs

Geophone Readout

Inputs from PI Geophones (see Sheet 8)

Geophone Distributor
D1402120
Front Panel
D1402122
Board
D1402121

Geophone Distributor
D1402120
Rear Panel
D1402123
Board
D1402121

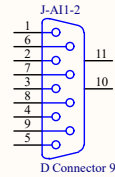
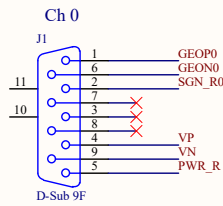

Generic D-Sub 9 Cable M-F

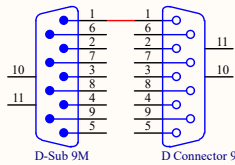

AA Chassis #1
JGW-D1100621

AA In 5-8

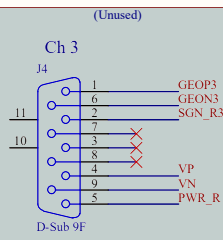
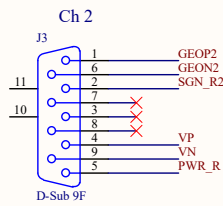
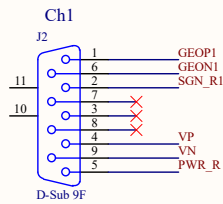
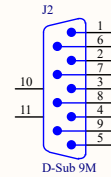

Title			BS Suspension Cabling - Geophone Readout		
Size	Number	Revision			
A3	JGW-D1503600	13	-v10		
Date:	2016/06/16	Sheet	of	14	
File:	\\.\13 Geophone Readout.SchDoc	Drawn By:			

OpLev Etc

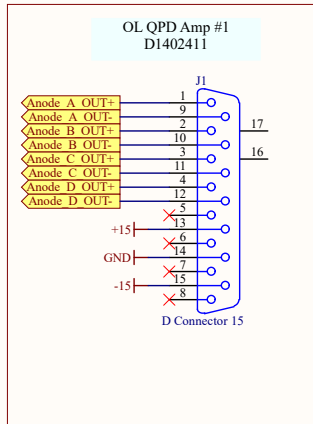

Generic D-Sub 15 Cable M-F

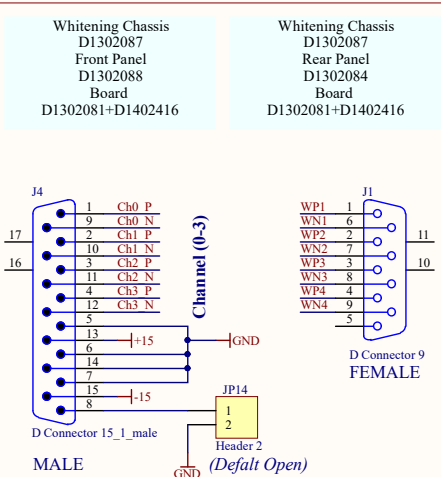
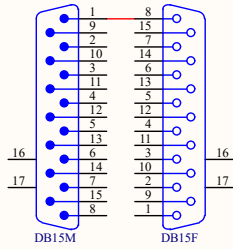

Generic D-Sub 9 Cable M-F

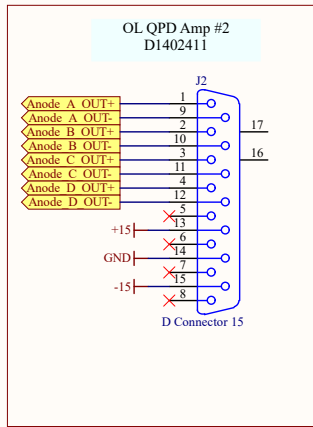
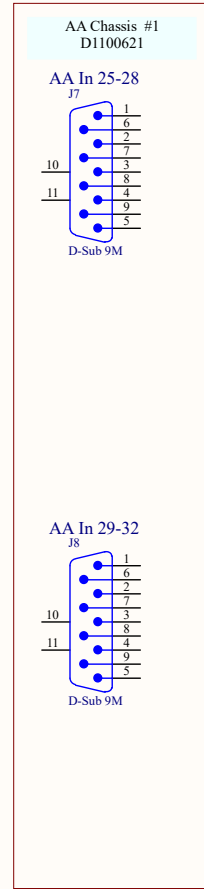
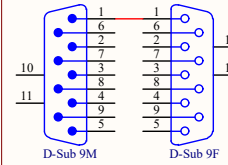

Generic D-Sub 15 Cable M-F

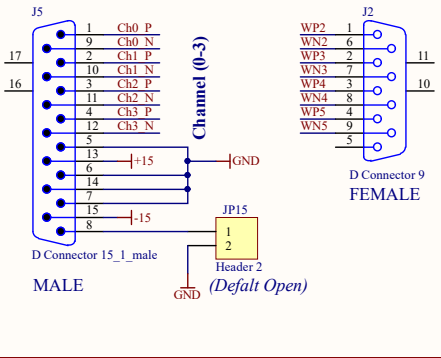
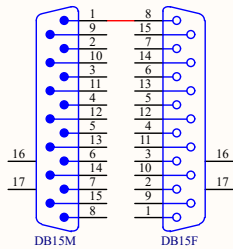

Generic D-Sub 9 Cable M-F

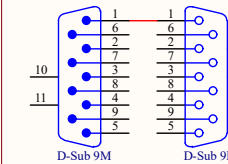

SECOND AA CHASSIS FOR TEST, SEISMOMETERS, ETC!!!

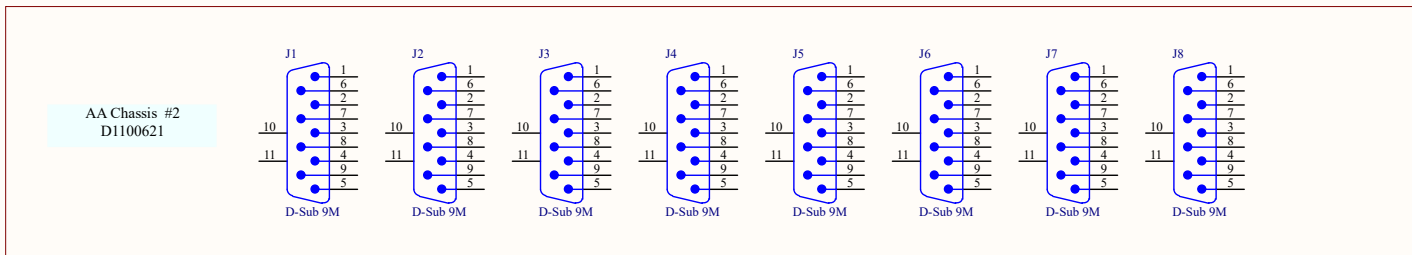

Title BS Suspension Cabling - OpLev Etc		
Size A3	Number JGW-D1503600	Revision -v10
Date: 2016/06/16	Sheet of 14	Drawn By:
File: \\.\14 OpLev Etc.SchDoe		