

4 Feedthroughs

TM OSEMs

Incorporates flip to correct flexicircuit issue!!!

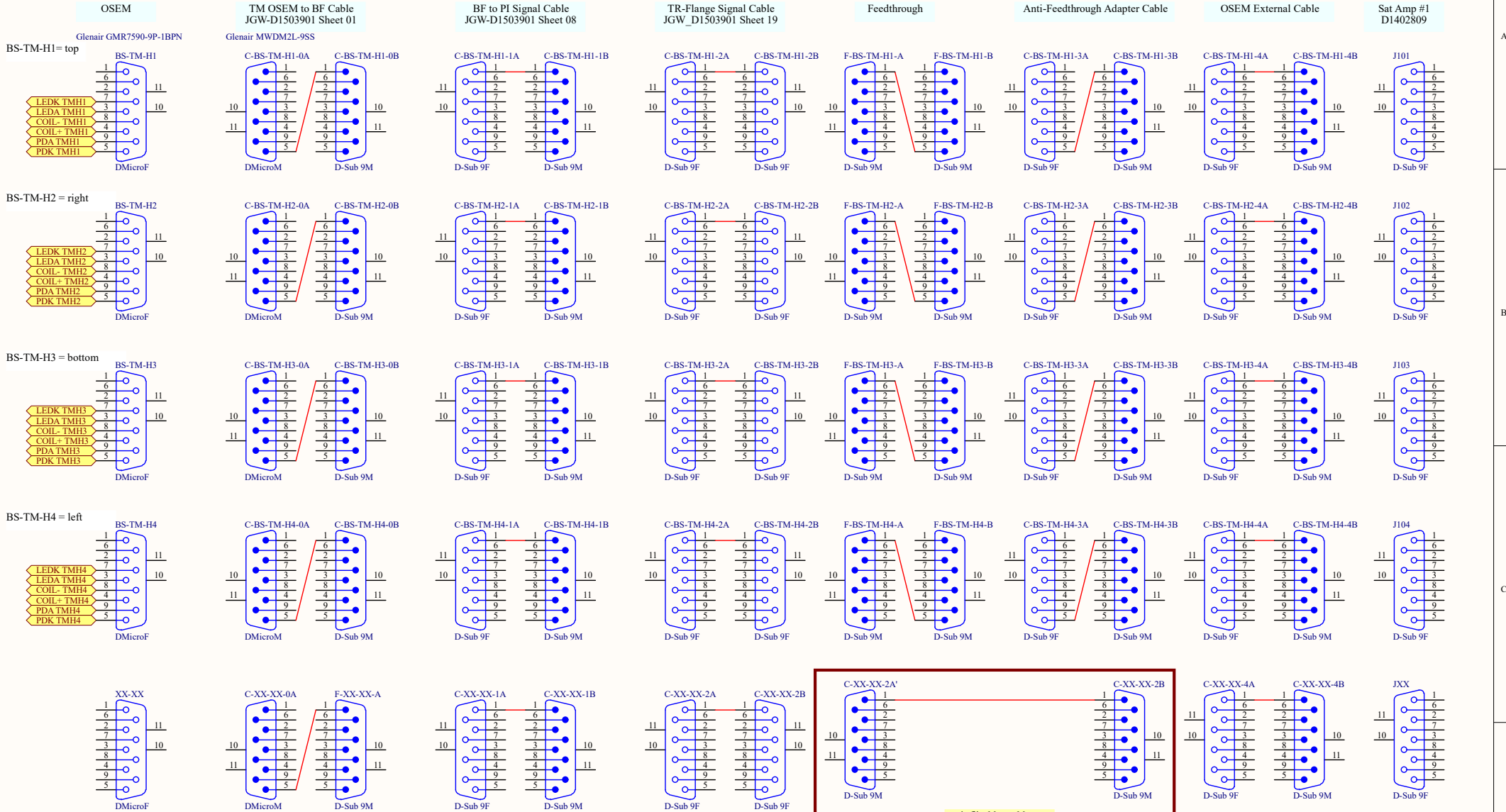

For testing the suspension outside the vacuum tank, there should be a supply of plain M-M gender changers to replace the combination of Feedthrough+Anti-Feedthrough adapter cable.

Title BS Suspension Cabling - Test Mass OSEMs		
Size A3	Number JGW-D1503600	Revision -v9
Date: 2016/04/12	Sheet 1 of 14	
File: \\..01 TM OSEMs.SchDoc	Drawn By:	

6 Feedthroughs

IM OSEMs

Incorporates flip to correct flexicircuit issue!!!
IM OSEM to BF Cable
JGW-D1503901 Sheet 02

OSEM

BF to PI Signal Cable
JGW-D1503901 Sheet 08

TR-Flange Signal Cable
JGW_D1503901 Sheet 19

Feedthrough

Anti-Feedthrough Adapter Cable

OSEM External Cable

Sat Amp #2
D1402809

A

Glennair GMR7590-9P-1BPN
BS-IM-H2

Glennair MWD2ML-9SS
C-BS-IM-H1-0A C-BS-IM-H1-0B

C-BS-IM-H1-1A C-BS-IM-H1-1B

C-BS-IM-H1-2A C-BS-IM-H1-2B

F-BS-IM-H1-A F-BS-IM-H1-B

C-BS-IM-H1-3A C-BS-IM-H1-3B

C-BS-IM-H1-4A C-BS-IM-H1-4B

J-BS-SA2-101

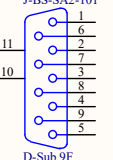
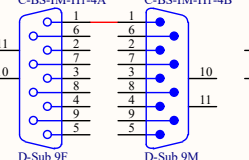
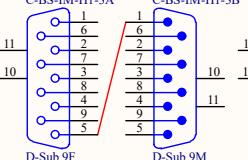
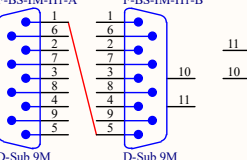
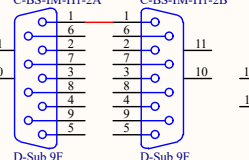
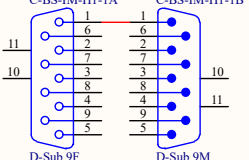
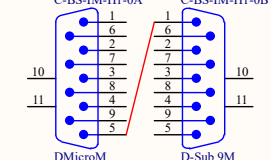
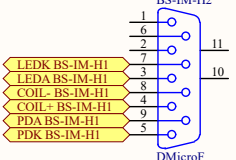

B

BS-IM-H3

C-BS-IM-H2-0A C-BS-IM-H2-0B

C-BS-IM-H2-1A C-BS-IM-H2-1B

C-BS-IM-H2-2A C-BS-IM-H2-2B

F-BS-IM-H2-A F-BS-IM-H2-B

C-BS-IM-H2-3A C-BS-IM-H2-3B

C-BS-IM-H2-4A C-BS-IM-H2-4B

J-BS-SA2-102

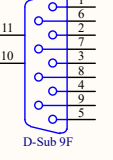
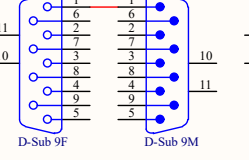
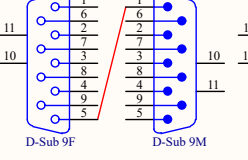
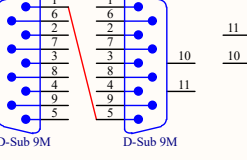
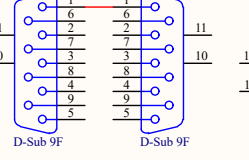
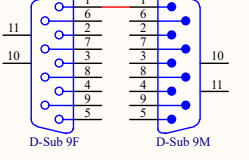
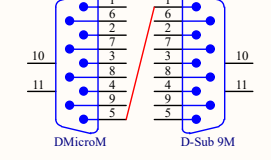
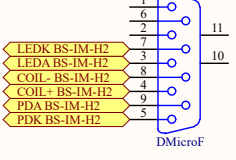

C

BS-IM-H4

C-BS-IM-H3-0A C-BS-IM-H3-0B

C-BS-IM-H3-1A C-BS-IM-H3-1B

C-BS-IM-H3-2A C-BS-IM-H3-2B

F-BS-IM-H3-A F-BS-IM-H3-B

C-BS-IM-H3-3A C-BS-IM-H3-3B

C-BS-IM-H3-4A C-BS-IM-H3-4B

J-BS-SA2-103

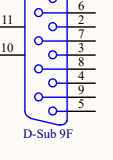
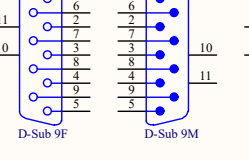
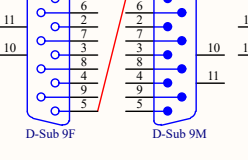
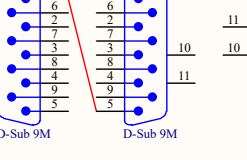
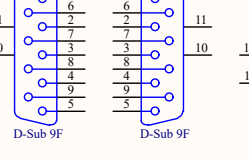
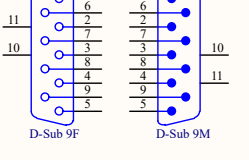
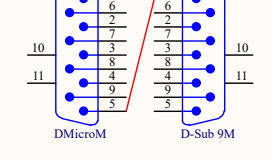
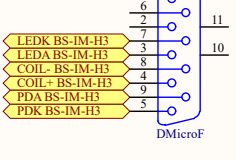

D

BS-IM-V1

C-BS-IM-V1-0A C-BS-IM-V1-0B

C-BS-IM-V1-1A C-BS-IM-V1-1B

C-BS-IM-V1-2A C-BS-IM-V1-2B

F-BS-IM-V1-A F-BS-IM-V1-B

C-BS-IM-V1-3A C-BS-IM-V1-3B

C-BS-IM-V1-4A C-BS-IM-V1-4B

J-BS-SA2-104

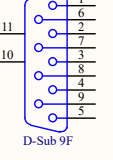
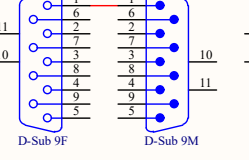
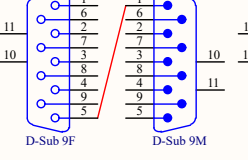
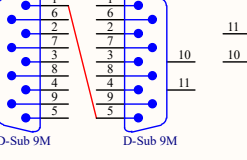
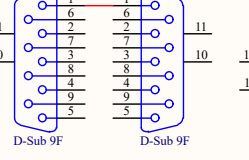
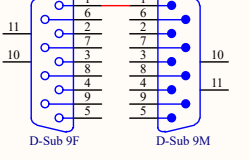
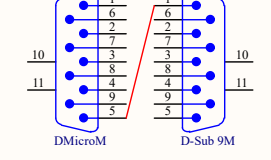
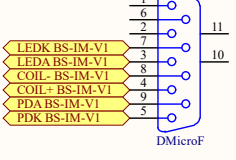

Sat Amp #3
D1402809

BS-IM-V2

C-BS-IM-V2-0A C-BS-IM-V2-0B

C-BS-IM-V2-1A C-BS-IM-V2-1B

C-BS-IM-V2-2A C-BS-IM-V2-2B

F-BS-IM-V2-A F-BS-IM-V2-B

C-BS-IM-V2-3A C-BS-IM-V2-3B

C-BS-IM-V2-4A C-BS-IM-V2-4B

J-BS-SA3-101

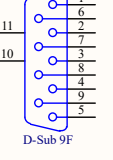
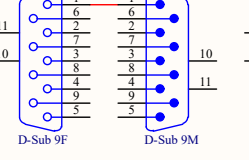
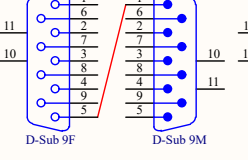
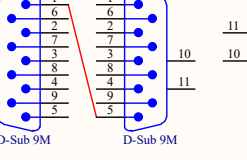
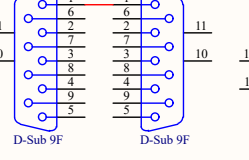
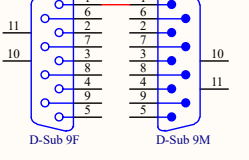
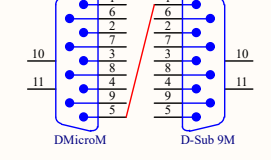
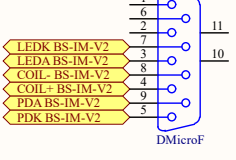

BS-IM-V3

C-BS-IM-V3-0A C-BS-IM-V3-0B

C-BS-IM-V3-1A C-BS-IM-V3-1B

C-BS-IM-V3-2A C-BS-IM-V3-2B

F-BS-IM-V3-A F-BS-IM-V3-B

C-BS-IM-V3-3A C-BS-IM-V3-3B

C-BS-IM-V3-4A C-BS-IM-V3-4B

J-BS-SA3-102

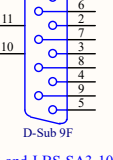
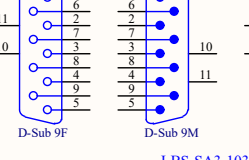
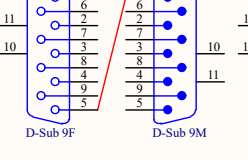
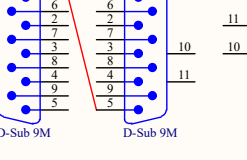
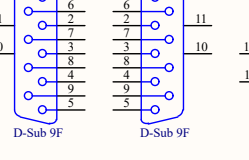
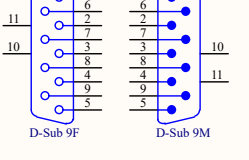
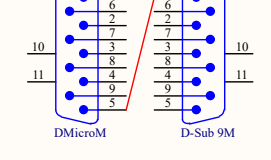
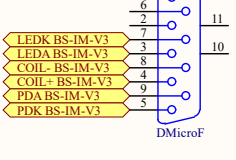

J-BS-SA3-103 and J-BS-SA3-104 not used

Title BS Suspension Cabling - Intermediate Mass OSEMs		
Size A3	Number JGW-D1503600	Revision -v9
Date 2016/04/12	Sheet 7 of 14	
File \\..02 IM OSEMs.SchDoc	Drawn By:	

1 Feedthrough

IM Picomotors

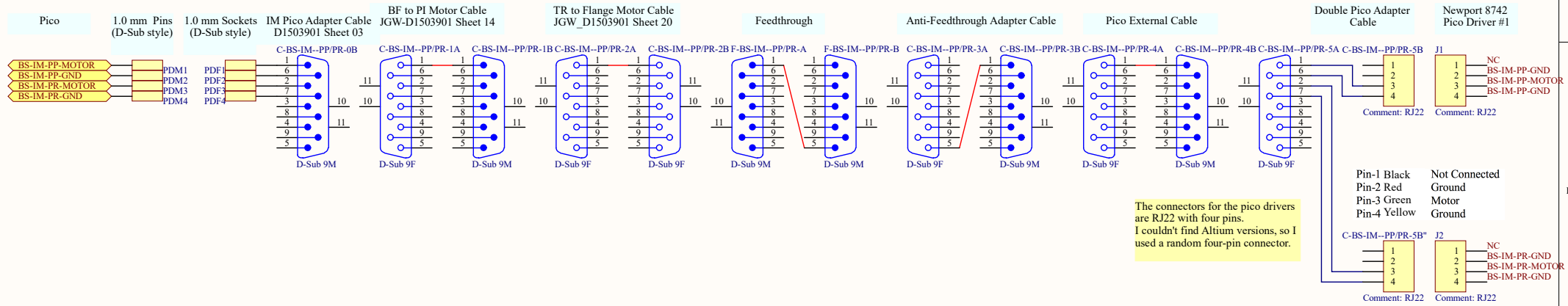

The connectors for the pico drivers are RJ22 with four pins. I couldn't find Altium versions, so I used a random four-pin connector.

Pin-1 Black
Pin-2 Red
Pin-3 Green
Pin-4 Yellow

Not Connected
Ground
Motor
Ground

Title BS Suspension Cabling - Intermediate Mass Picos			
Size A3	Number JGW-D1503600	Revision -v9	
Date: 2016/04/12	Sheet 3 of 14	Drawn By:	
File: \\...03 IM Picos.SchDoc			

BF and SF Picomotors and Steppers

3 Feedthroughs

Pin-1 Black Not Connected
 Pin-2 Red Ground
 Pin-3 Green Motor
 Pin-4 Yellow Ground

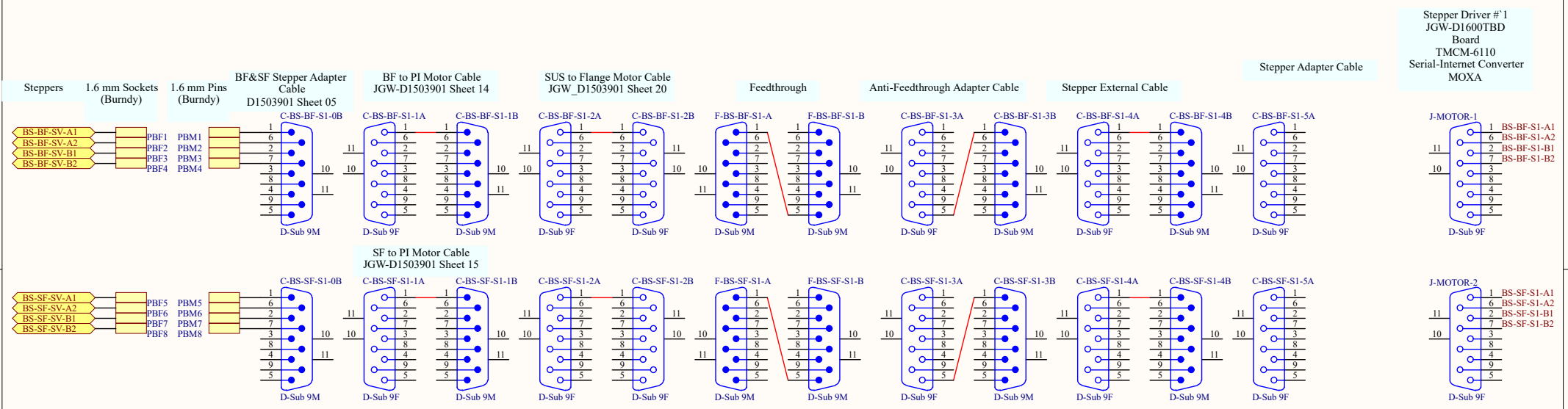
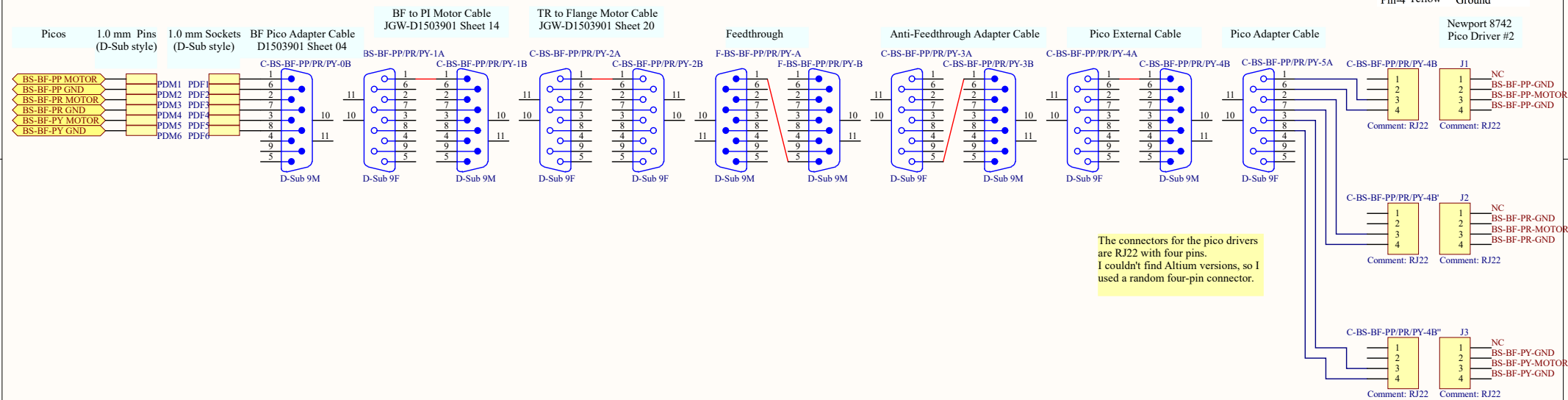

Title			BS Suspension Cabling - Bottom and Standard Filter Picos/Steppers		
Size	Number	JGW-D1503600		Revision	-v9
A3					
Date:	2016/04/12	Sheet 4 of 14			
File:	\\.\04 BF&SF Picos&Steppers.SchDoc	Drawn By:			

BF and SF LVDT/ACTs

2 Feedthroughs

LVDT/ACT Distributor
JGW-D1402124,
Front Panel
JGW-D1402827
Board
JGW-D1402117 #2

LVDT/Act

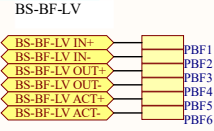

BF&SF LVDT Adapter Cable
JGW-D1503901 Sheet 06

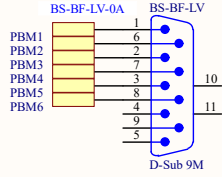

BF-PI Signal Cable
JGW-D1503901 Sheet 08

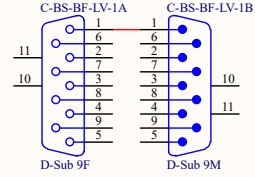

TR-Flange Signal Cable
JGW_D1503901 Sheet 19

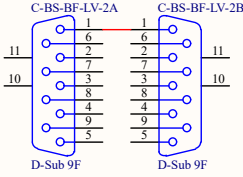

Feedthrough

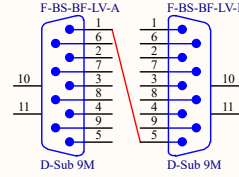

Feedthrough Adapter Cable

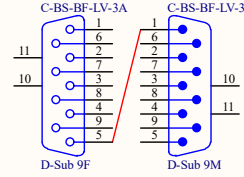

External Cable

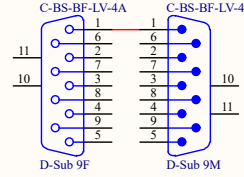

Ch 4

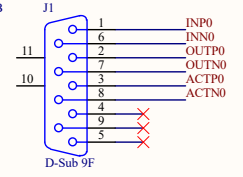

LVDT/Act

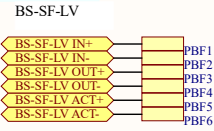

BF&SF LVDT Adapter Cable
JGW-D1503901 Sheet 06

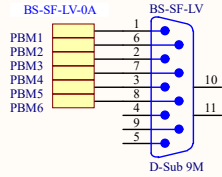

SF-PI Signal Cable
JGW-D1503901 Sheet 09

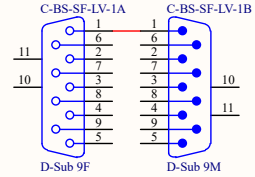

TR-Flange Signal Cable
JGW_D1503901 Sheet 19

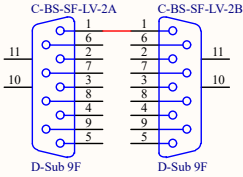

Feedthrough

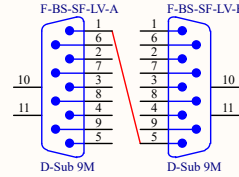

Feedthrough Adapter Cable

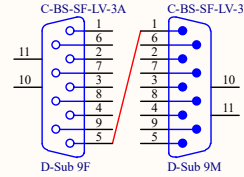

External Cable

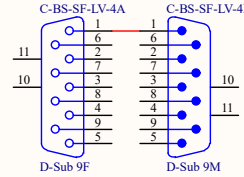

Ch 5

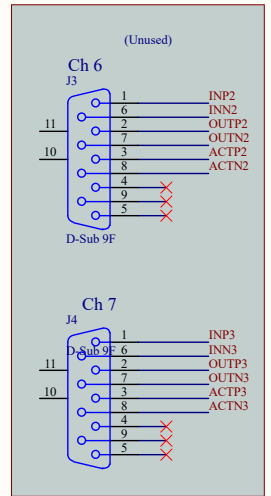
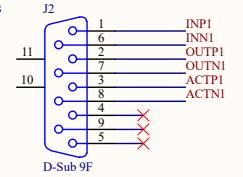

Title			
BS Suspension Cabling - Bottom and Standard Filter LVDTs			
Size	Number	Revision	
A3	JGW-D1503600	-v9	
Date:	2016/04/12	Sheet 5of 14	
File:	\\.\05 BF&SF LVDTs.SchDoc	Drawn By:	

4 Feedthroughs

Preisolator LVDT/ACTs

LVDT/ACT

OPTIONAL
Signal Cable Extension
JGW_D1503901 Sheet 10

TR-Flange Signal Cable
JGW_D1503901 Sheet 19

Feedthrough

Anti-Feedthrough Adapter Cable

LVDT/ACT External Cable

LVDT/ACT Distributor
JGW-D1402124,
Front Panel
JGW-D1402827
Board
JGW-D1402117 #1

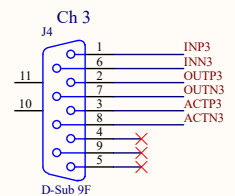
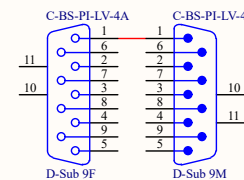
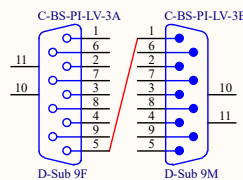
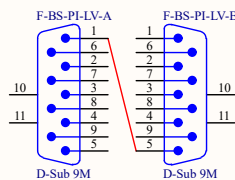
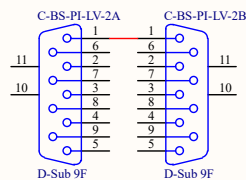
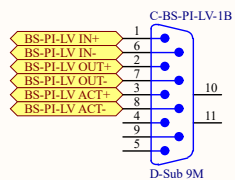
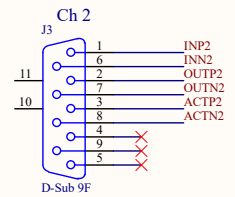
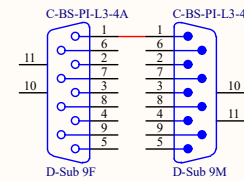
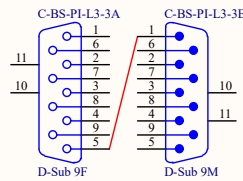
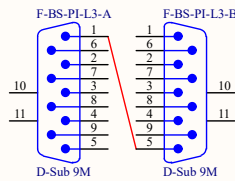
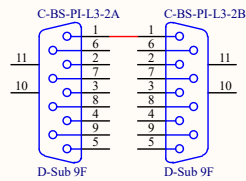
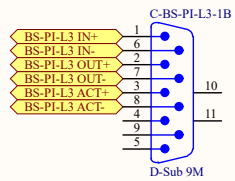
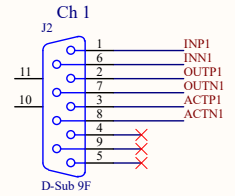
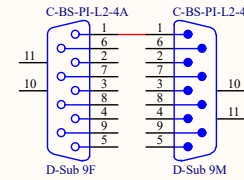
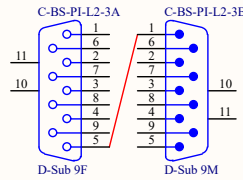
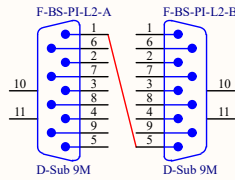
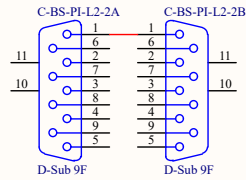
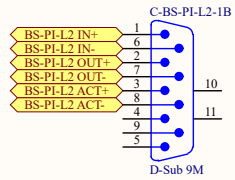
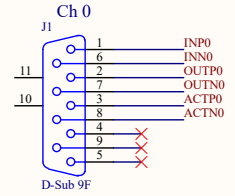
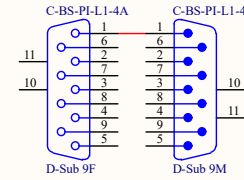
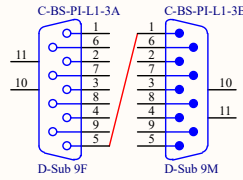
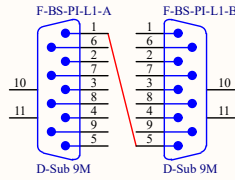
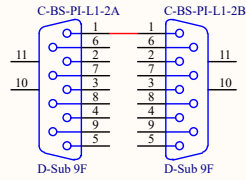
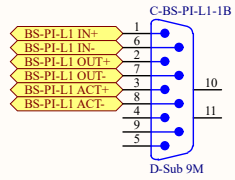

LVDT-COIL

Pin	Function
1	LVDT IN P
2	LVDT OUT P
3	COIL P
4	
5	
6	LVDT IN N
7	LVDT OUT N
8	COIL N
9	

Title		
BS Suspension Cabling - Preisolator LVDT/Actuators		
Size	Number	Revision
A3	JGW-D1503600	-v9
Date:	2016/04/12	Sheet 6of 14
File:	\\.\06 PI LVDTs.SchDoc	Drawn By:

4 Feedthroughs

Preisolator Steppers

TMCM-6110 Stepper Driver #2

Stepper Driver #2
JGW-D1600TBD Board
TMCM-6110
Serial-Internet Converter
MOXA

Stepper

PI Stepper Adapter
JGW-D1503901 Sheet 24

OPTIONAL

Motor Cable Extension
JGW_D1503901 Sheet 16

TR to Flange Motor Cable
JGW-D1503901 Sheet 20

Feedthrough

Anti-Feedthrough Adapter Cable

Stepper External Cable

Stepper Splitter Cable
Double Motor Version

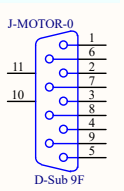
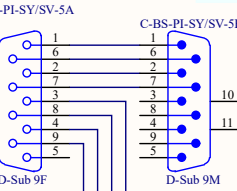
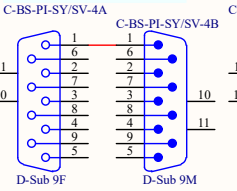
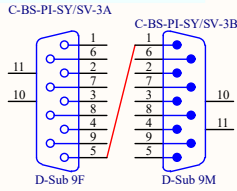
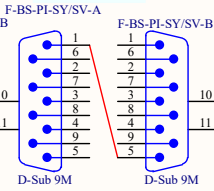
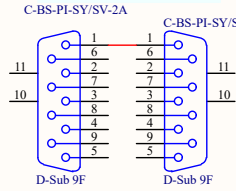
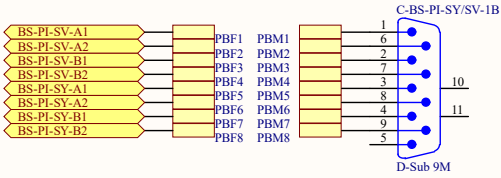

The vertical and yaw steppers have no limit switches and are combined on a single cable that VIS needs to provide.

The horizontal steppers have limit switches and will be wired as indicated by the IP manufacturer.

PI to Flange Motor Cable
JGW-D1503901 Sheet 13

Stepper Splitter Cable
Motor+Switch Version

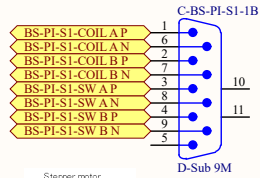

Pin	Function
1	COIL A P
2	COIL B P
3	Switch 1 P
4	Switch 2 P
5	
6	COIL A N
7	COIL B N
8	Switch 1 N
9	Switch 2 N

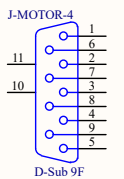
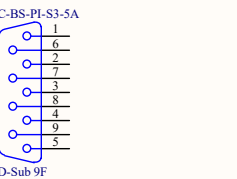
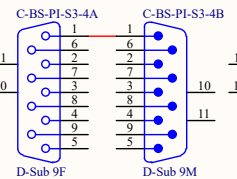
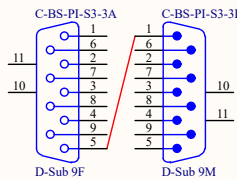
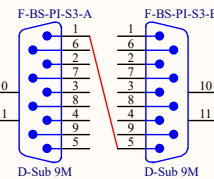
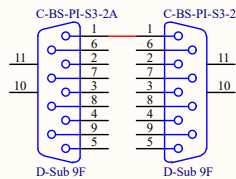
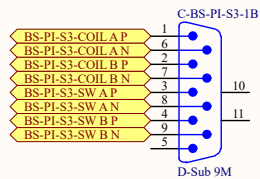
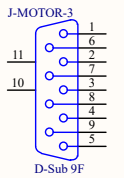
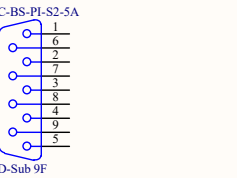
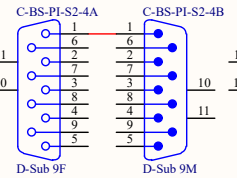
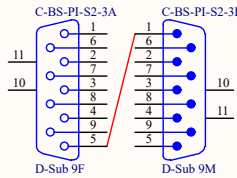
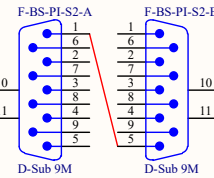
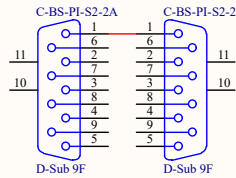
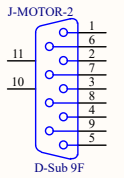
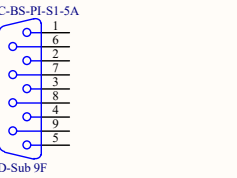
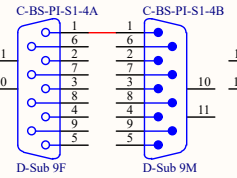
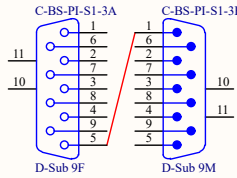
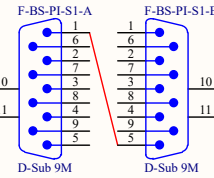
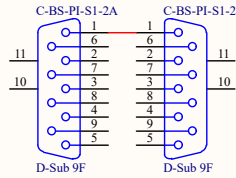
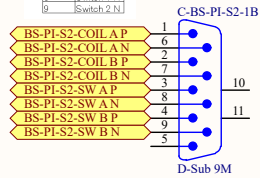

Title BS Suspension Cabling - Preisolator Steppers		
Size A3	Number JGW-D1503600	Revision -v9
Date: 2016/04/12	Sheet 7 of 14	
File: \\..07 PI Steppers.SchDoc	Drawn By:	

3 Feedthroughs

Preisolator Geophones

Geophone Pod Internal Cabling
(same for all three pods):

Pod #1: geophone L400002322, preamp 15
Pod #2: geophone L400002321, preamp 12
Pod #3: geophone L400002323, preamp 14



Note: The usual TR to Flange Signal Cable (D1503901 Sheet 19) cannot be used here because it doesn't have a conductor on Pin 5!!!



Geophone Pod

Geophone Adapter Cable
JGW-D1503901 Sheet 07

PI to Flange Geophone Cable
JGW-E1503901 Sheet 12

Feedthrough

Anti-Feedthrough Adapter Cable

Geophone External Cable

Geophone Distributor
JGW-D1402120

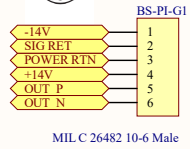

(A) 1
(B) 2
(C) 3
(D) 4
(E) 5
(F) 6

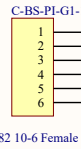

(A) 1
(B) 2
(C) 3
(D) 4
(E) 5
(F) 6

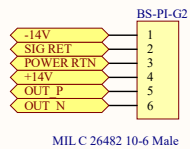
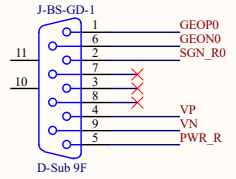
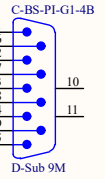
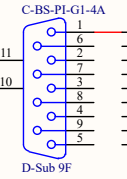
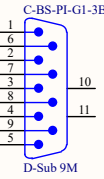
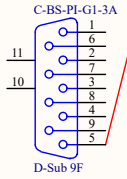
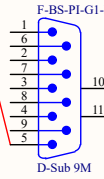
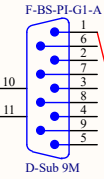
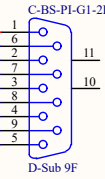
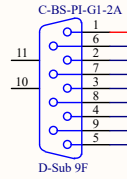
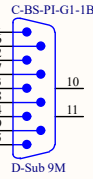

(A) 1
(B) 2
(C) 3
(D) 4
(E) 5
(F) 6

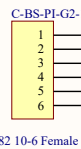

(A) 1
(B) 2
(C) 3
(D) 4
(E) 5
(F) 6

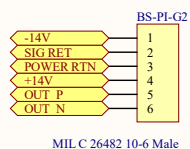
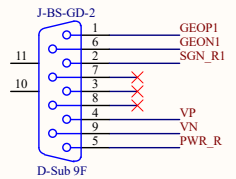
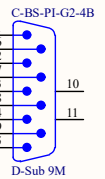
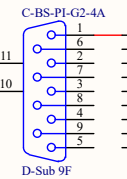
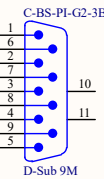
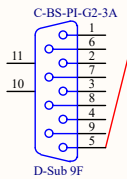
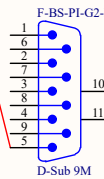
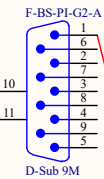
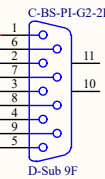
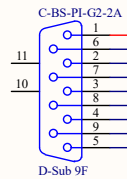
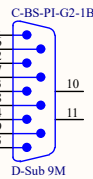

(A) 1
(B) 2
(C) 3
(D) 4
(E) 5
(F) 6

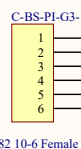

(A) 1
(B) 2
(C) 3
(D) 4
(E) 5
(F) 6

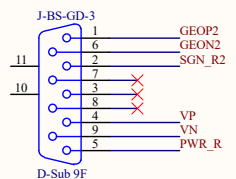
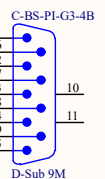
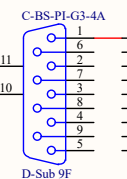
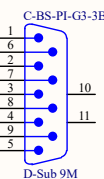
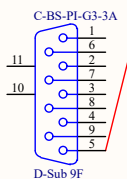
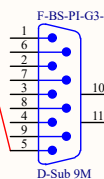
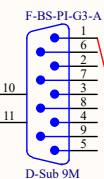
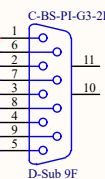
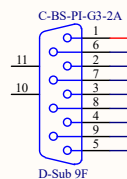
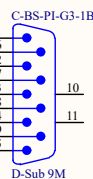

J-BS-GD-4 not used

Title BS Suspension Cabling - Preisolator Geophones		
Size A3	Number JGW-D1503600	Revision -v9
Date: 2016/04/12	Sheet 8 of 14	Drawn By:
File: \\.\08 PI Geophones.SchDoc		

OSEM Sat Amps and Drivers

Sat Amp Inputs from OSEMs (see Sheets 1&2)

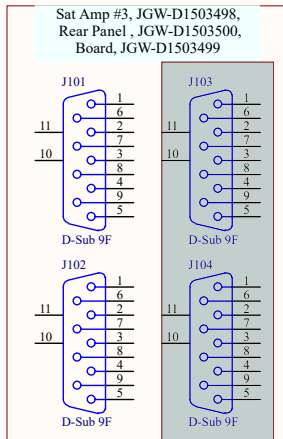
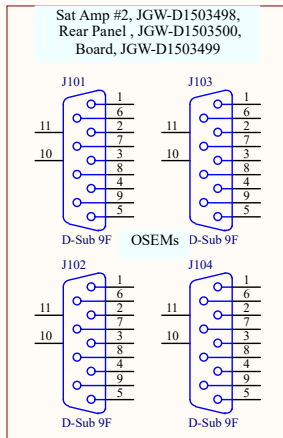
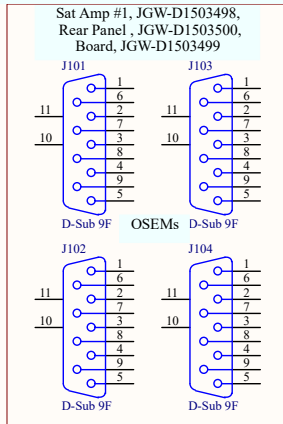

Sat Amp PD Outputs

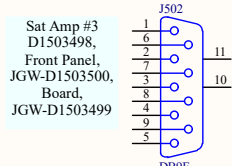
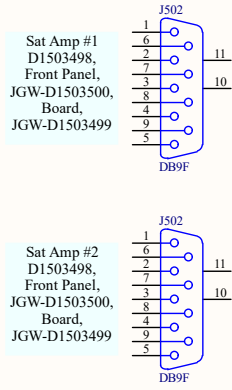

Sat Amp LED Current Monitor Outputs

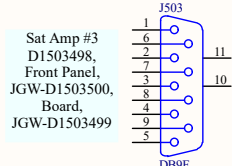
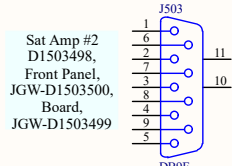
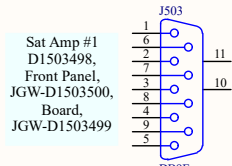

Generic D-Sub 9 Cable M-F

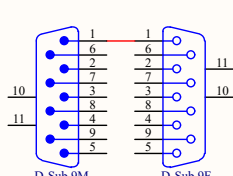
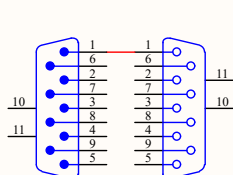
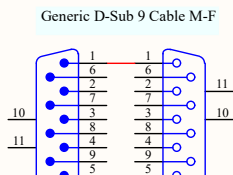
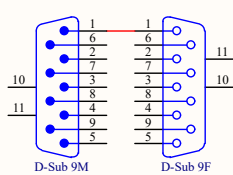
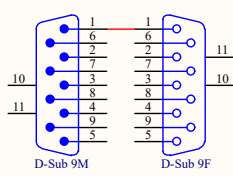
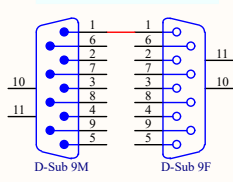

AA Chassis #1 D1100621

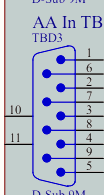
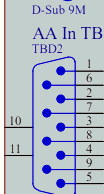
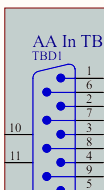
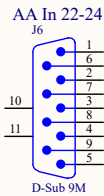
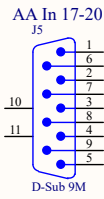
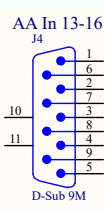

Sat Amp #1
JGW-D1503498,
Front,
JGW-D1503500,
Board,
JGW-D1503499

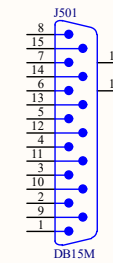

Sat Amp #2
JGW-D1503498,
Front,
JGW-D1503500,
Board,
JGW-D1503499

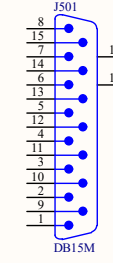

Sat Amp #3
JGW-D1503498,
Front,
JGW-D1503500,
Board,
JGW-D1503499

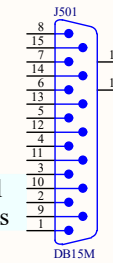

Sat Amp Coil Current Inputs

Low Power Coil Driver #1
JGW-D1503506,
Front Panel,
JGW-D1503508,
Board,
JGW-D1503507

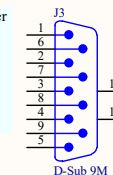

Low Power Coil Driver #2
JGW-D1503506,
Front Panel,
JGW-D1503508,
Board,
JGW-D1503507

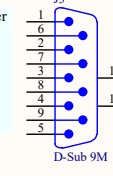

Low Power Coil Driver #3
JGW-D1503506,
Front Panel,
JGW-D1503508,
Board,
JGW-D1503507

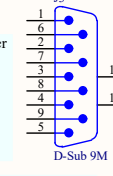

Coil Current Request Inputs

Generic D-Sub 15 Cable M-F

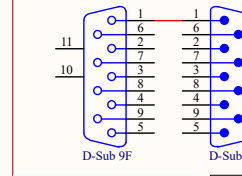
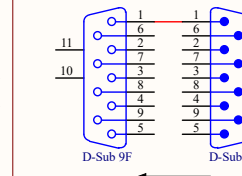
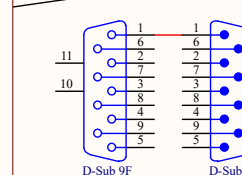
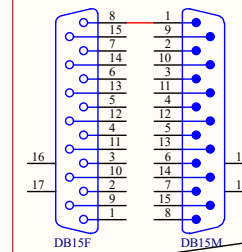
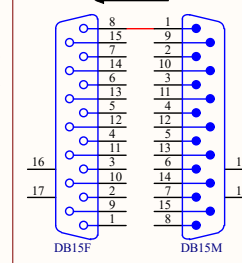
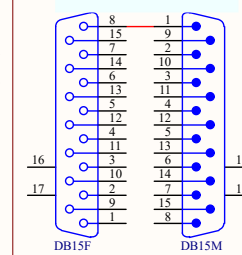

Generic D-Sub 9 Cable M-F

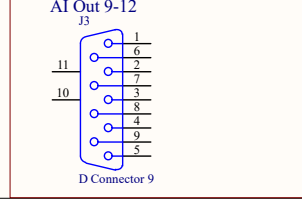
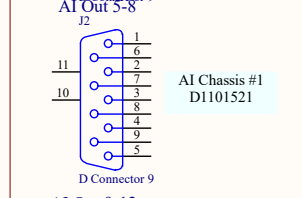
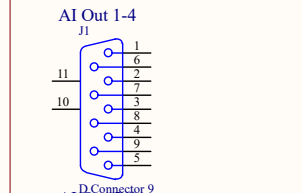
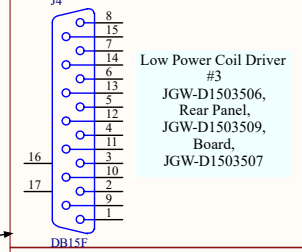
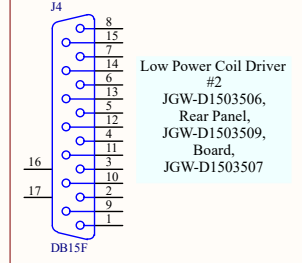
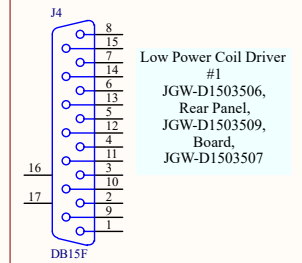

Title			BS Suspension Cabling - OSEM Sat Amps & Drivers		
Size	Number	JGW-D1503600		Revision	-v9
A3	Date:	2016/04/12	Sheet	9 of	14
	File:	\\..09 Sat Amps & Coil Drivers.SchDoc	Drawn By:		

BS&SF LVDT Drivers

Inputs from
BS&SF
LVDTs
(see Sheet 5)

LVDT/ACT Distributor
JGW-D1402124,
Rear Panel
JGW-D1402828,
Board
JGW-D1402117 #2

Ch 4-7 LVDT-IN

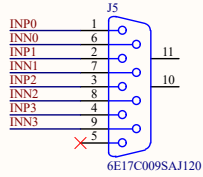

LVDT/ACT Distributor
JGW-D1402124,
Front Panel
JGW-D1402827
Board
JGW-D1402117 #2

Ch 4

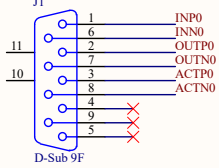

Ch 5

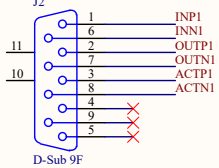

2 inputs
unused

Ch 6
Ch 7

Ch 4-7 LVDT-OUT

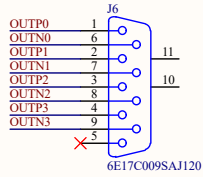

Ch 4-7 ACT

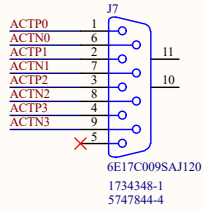

Generic D-Sub 9 Cable M-F

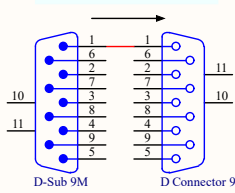

Generic D-Sub 9 Cable M-F

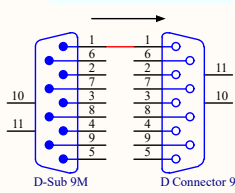

LVDT-Coil Driver Cable

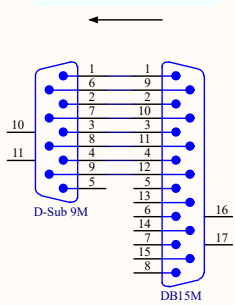

LVDT Driver Chassis
JGW-D1402826,
Front Panel
JGW-D1402827
Input Board #2
JGW-D1301467

LVDT Driver Chassis
JGW-D1402826,
Front Panel
JGW-D1402827
Main Board
JGW-D1301467

LVDT MAIN (Right)

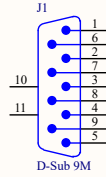
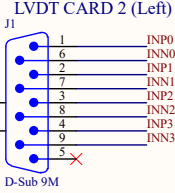

LVDT CARD 2 (Right)

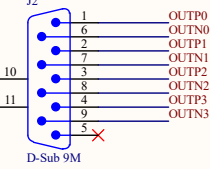

High Power Coil Driver #2
JGW-D1503504,
Rear Panel,
JGW-D1503505,
Monitor Board
JGW-D1503510

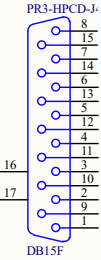

High Power Coil Driver #1
JGW-D1503504,
Front Panel,
JGW-D1503502,
Driver Board
JGW-D1503503

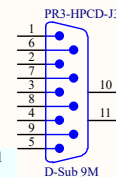

Gender Bender F-F

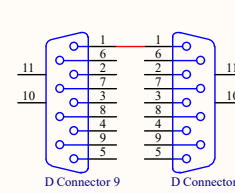

Generic D-Sub 9 Cable M-F

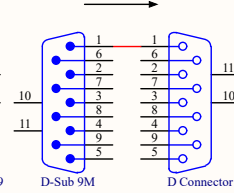

AA Chassis #1
JGW-D1100621

AA In 9-12

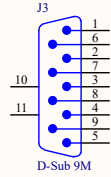

Generic D-Sub 9 Cable M-F

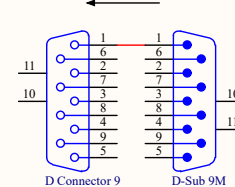

AI Chassis #2
D1101521

AI Out 1-4

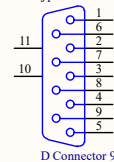

Signal Generator
10 kHz, 5 V



The LVDT Chassis has provision for an oscillator card, but until such time as the cards are available, an external oscillator will be required

Cable

LVDT Driver Chassis
JGW-D1402826,
Front Panel
JGW-D1402827
Interface Board
JGW-D1402829



Title BS Suspension Cabling - BS&SF LVDT Drivers		
Size A3	Number JGW-D1503600	Revision -v9
Date: 2016/04/12	Sheet of 10	Sheet of 14
File: \\.\10 BS&SF LVDT Drive.SchDoc	Drawn By:	

**Inputs from PI LVDTs
(see Sheet 6)**

LVDT/ACT Distributor
JGW-D1402124,
Rear Panel
JGW-D1402828,
Board
JGW-D1402117 #1

LVDT/ACT Distributor
JGW-D1402124,
Front Panel
JGW-D1402827
Board
JGW-D1402117 #1

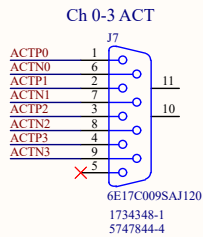
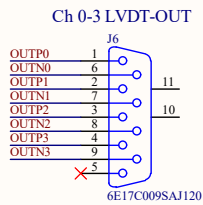
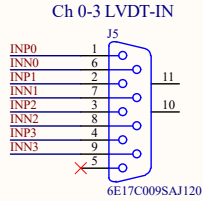
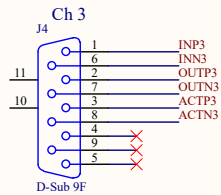
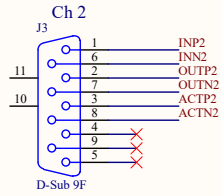
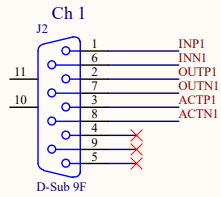
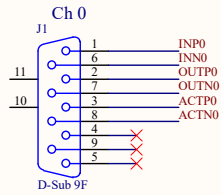

PI LVDT Drivers

LVDT Driver Chassis
JGW-D1402826,
Front Panel
JGW-D1402827
Input Board #1
JGW-D1301467

LVDT Driver Chassis
JGW-D1402826,
Front Panel
JGW-D1402827
Main Board
JGW-D1301467

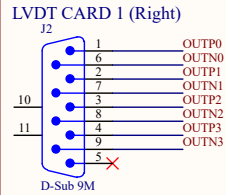
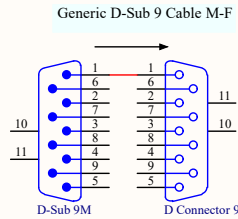
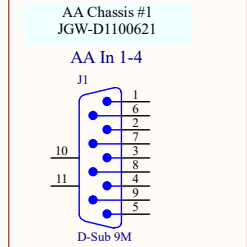
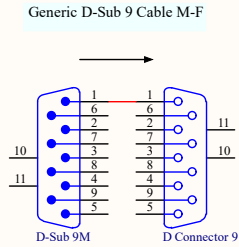
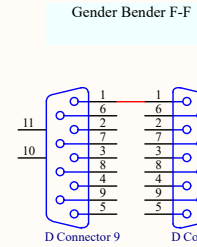
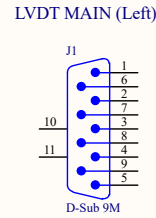
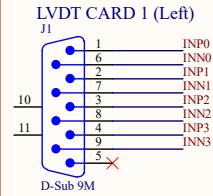
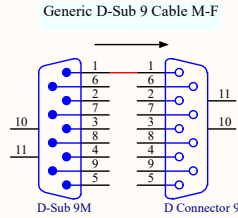

LVDT-Coil Driver Cable

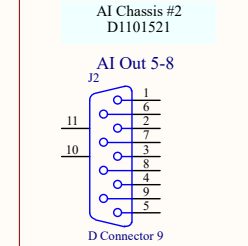
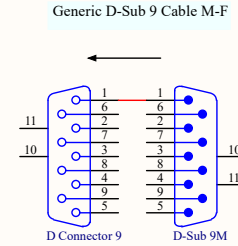
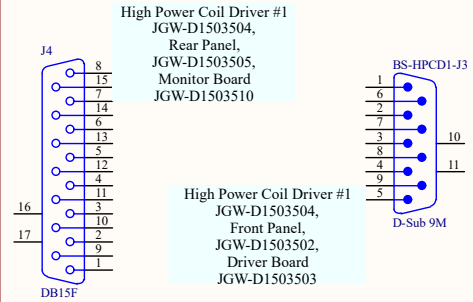
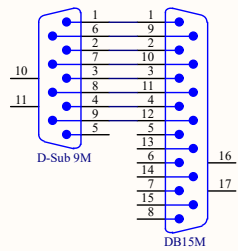

Title		
BS Suspension Cabling - PI LVDT Drivers		
Size	Number	Revision
A3	JGW-D1503600	-v9
Date:	2016/04/12	Sheet of 14
File:	\\M11 PI LVDT Drive.SchDoc	Drawn By:

Pico and Stepper Drivers

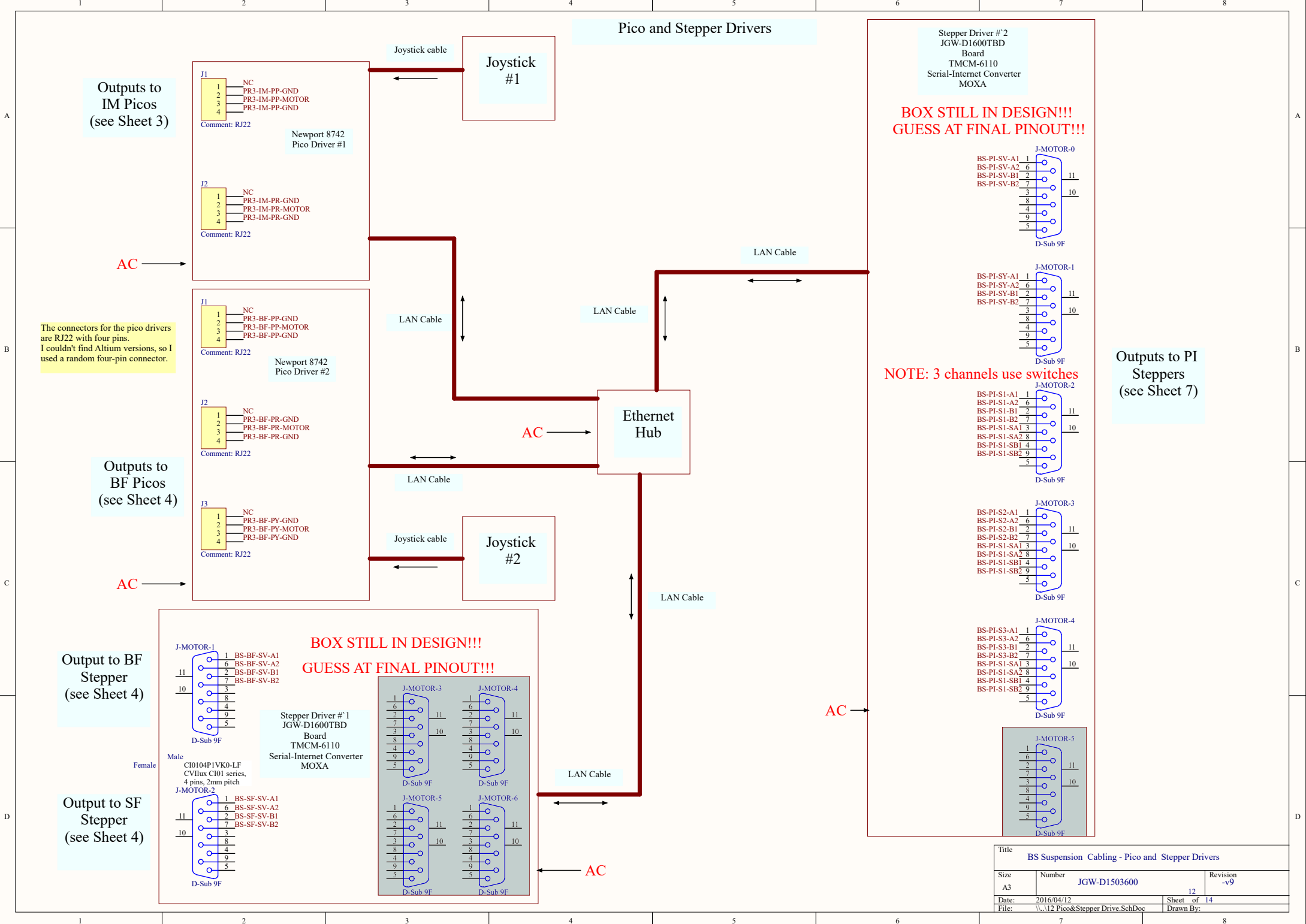

Outputs to IM Picos (see Sheet 3)

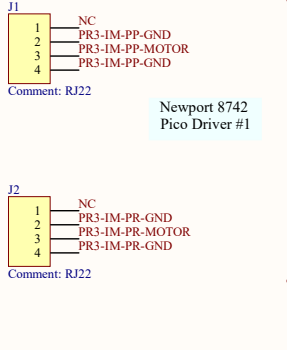

AC

The connectors for the pico drivers are RJ22 with four pins. I couldn't find Altium versions, so I used a random four-pin connector.

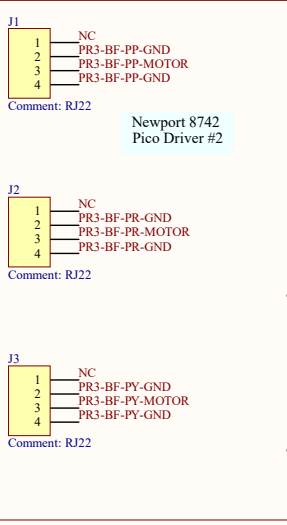

Outputs to BF Picos (see Sheet 4)

AC



Output to BF Stepper (see Sheet 4)

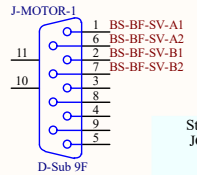

**BOX STILL IN DESIGN!!!
GUESS AT FINAL PINOUT!!!**

Stepper Driver #1
 JGW-D1600TBD Board
 TMC6110
 Serial-Internet Converter
 MOXA

Female

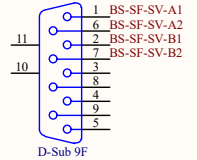

Output to SF Stepper (see Sheet 4)

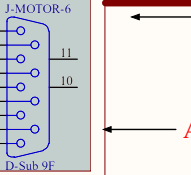
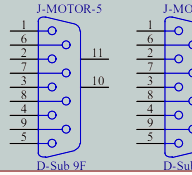
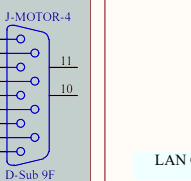
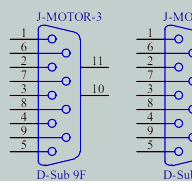

AC

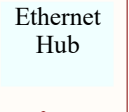

Stepper Driver #2
 JGW-D1600TBD Board
 TMC6110
 Serial-Internet Converter
 MOXA

**BOX STILL IN DESIGN!!!
GUESS AT FINAL PINOUT!!!**

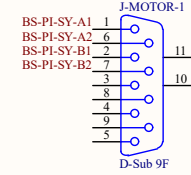
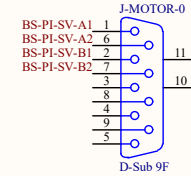

NOTE: 3 channels use switches

Outputs to PI Steppers (see Sheet 7)

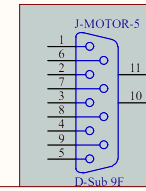
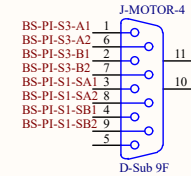
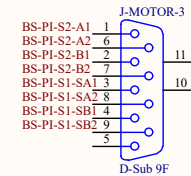
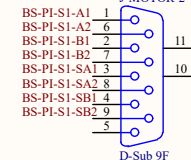

Title			BS Suspension Cabling - Pico and Stepper Drivers		
Size	Number	Revision			
A3	JGW-D1503600	12	-v9		
Date:	2016/04/12	Sheet	of		14
File:	\\.\12 Pico&Stepper Drive.SchDoc	Drawn By:			

3 Feedthroughs

Geophone Readout

Inputs from PI Geophones (see Sheet 8)

Geophone Distributor
D1402120
Front Panel
D1402122
Board
D1402121

Geophone Distributor
D1402120
Rear Panel
D1402123
Board
D1402121

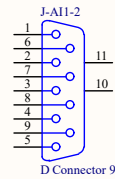
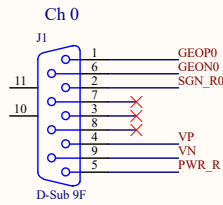

Generic D-Sub 9 Cable M-F

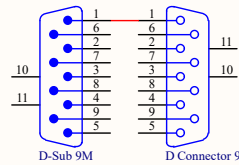

AA Chassis #1
JGW-D1100621

AA In 5-8

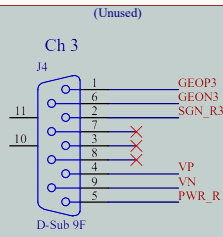
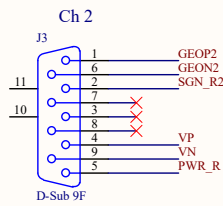
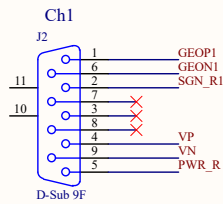
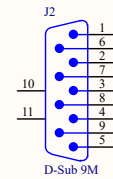

Title			BS Suspension Cabling - Geophone Readout		
Size	Number	Revision			
A3	JGW-D1503600	13	-v9		
Date:	2016/04/12	Sheet	of	14	
File:	\\.\13 Geophone Readout.SchDoc	Drawn By:			

OpLev Etc

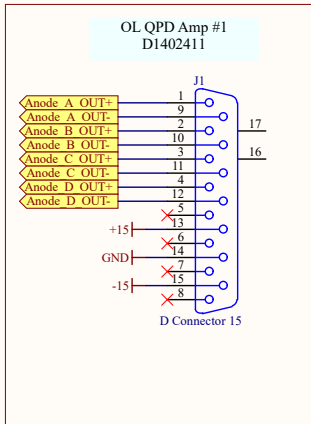

Generic D-Sub 15 Cable M-F

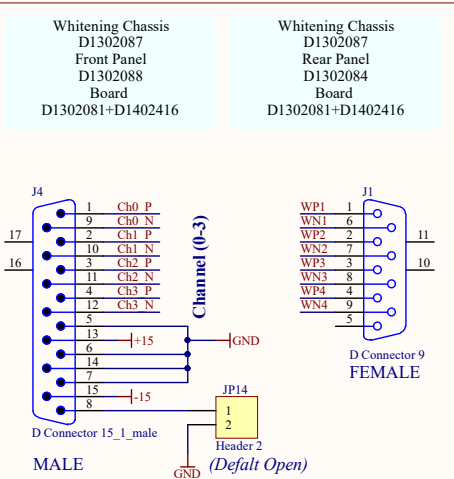
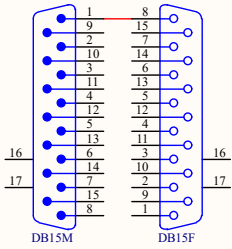

Generic D-Sub 9 Cable M-F

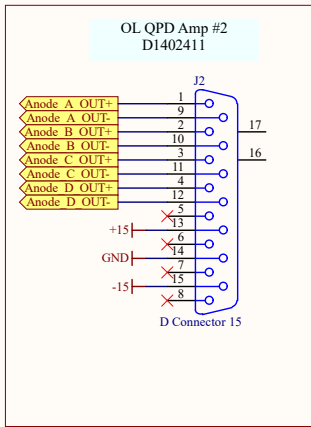
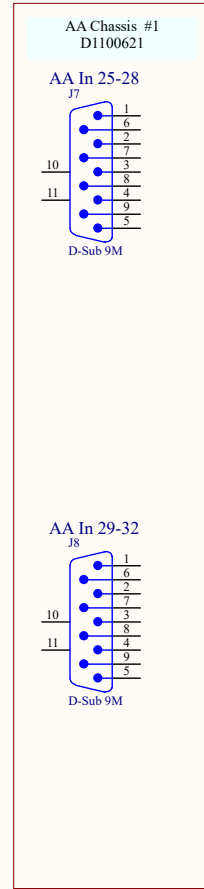
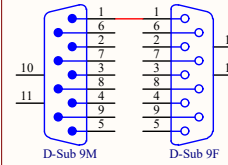

Generic D-Sub 15 Cable M-F

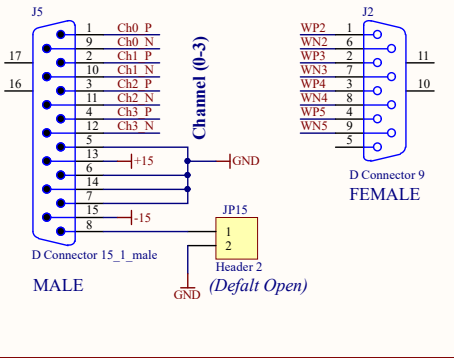
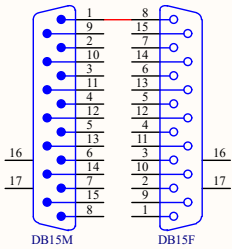

Generic D-Sub 9 Cable M-F

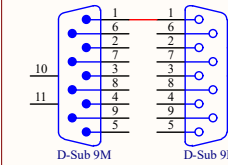

SECOND AA CHASSIS FOR TEST, SEISMOMETERS, ETC!!!

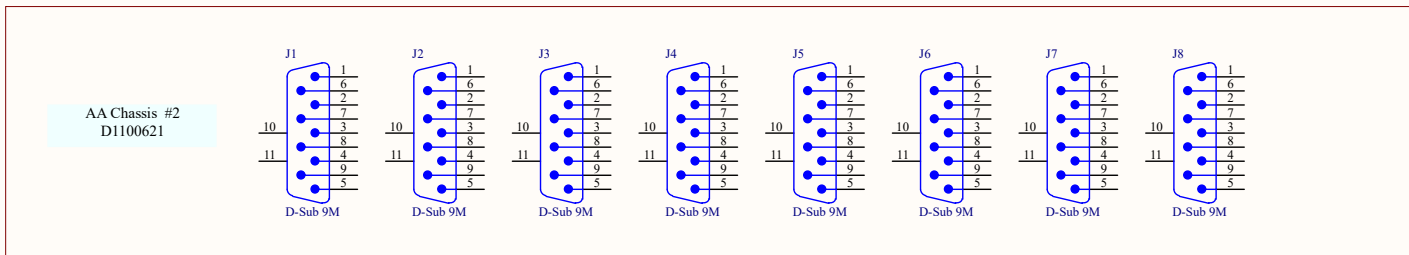

Title BS Suspension Cabling - OpLev Etc		
Size A3	Number JGW-D1503600	Revision -v9
Date: 2016/04/12	Sheet of 14	Drawn By: 14
File: \\.\14 OpLev Etc.SchDoe		