

4 Feedthroughs

TM OSEMs

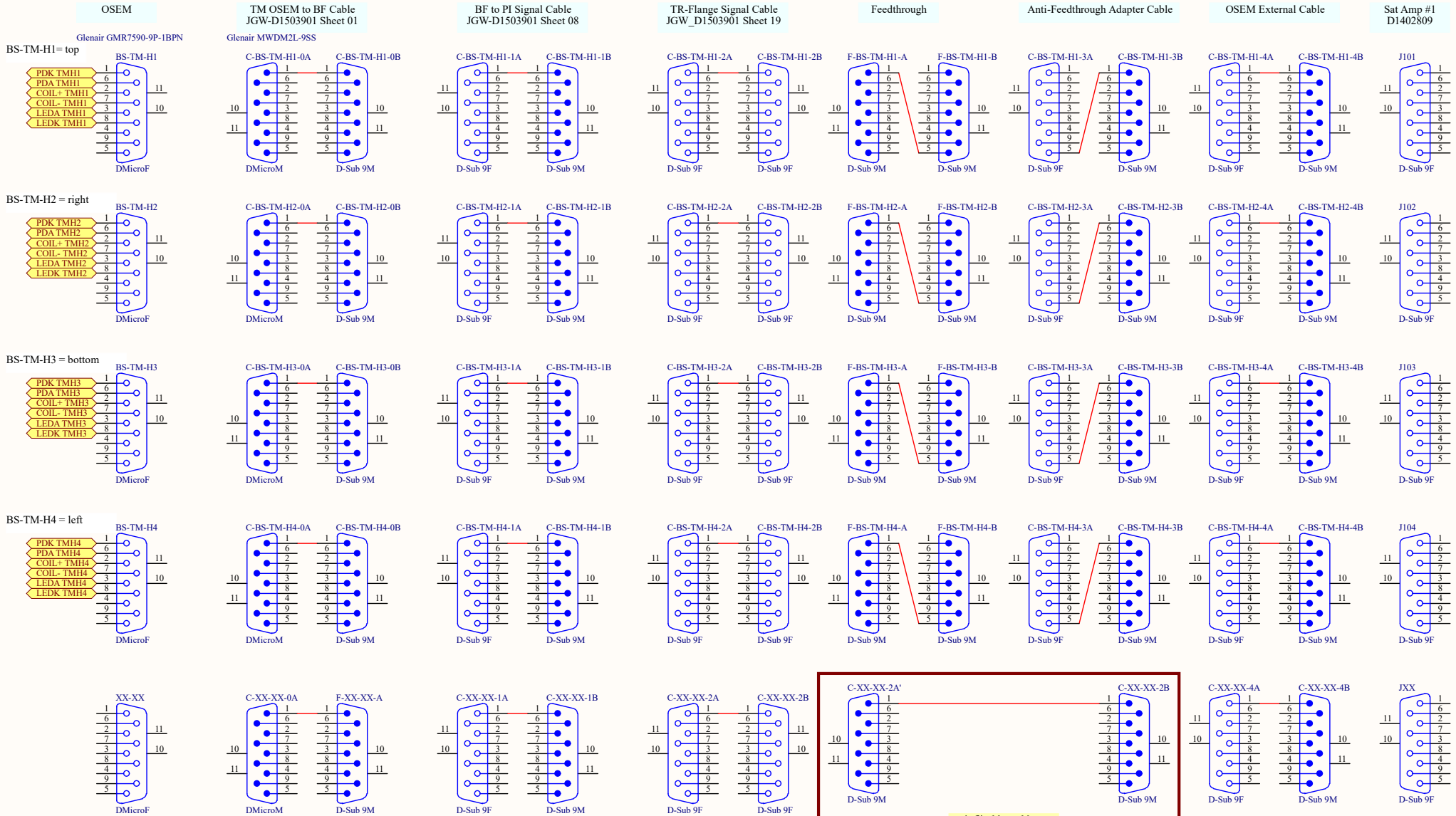

For testing the suspension outside the vacuum tank, there should be a supply of plain M-M gender changers to replace the combination of Feedthrough+Anti-Feedthrough adapter cable.

Title			BS Suspension Cabling - Test Mass OSEMs		
Size	Number			Revision	
A3	JGW-D1503600			-v7	
Date:	2016/04/10	Sheet		of 14	
File:	\\..01 TM OSEMs.SchDoc	Drawn By:			

6 Feedthroughs

IM OSEMs

OSEM

IM OSEM to BF Cable JGW-D1503901 Sheet 02

BF to PI Signal Cable JGW-D1503901 Sheet 08

TR-Flange Signal Cable JGW-D1503901 Sheet 19

Feedthrough

Anti-Feedthrough Adapter Cable

OSEM External Cable

Sat Amp #2 D1402809

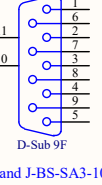
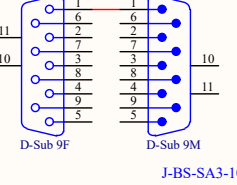
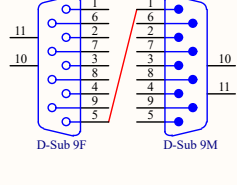
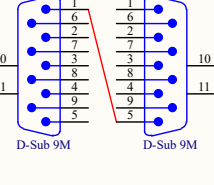
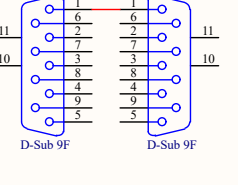
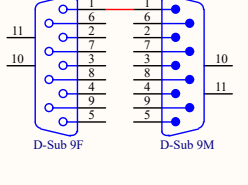
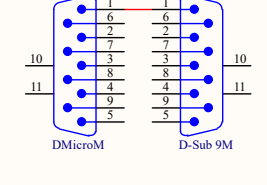
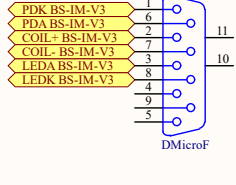
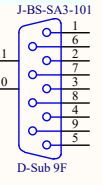
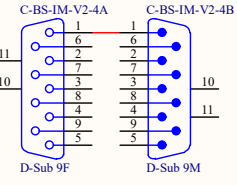
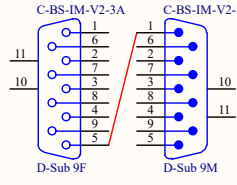
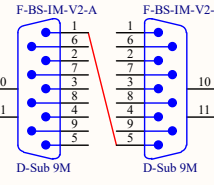
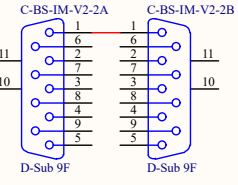
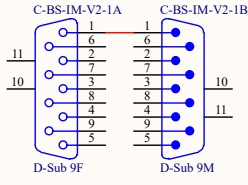
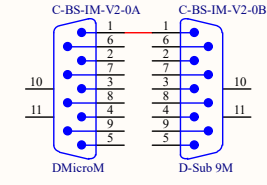
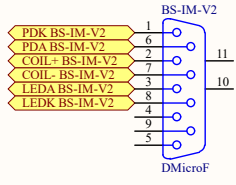
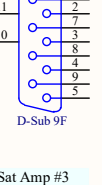
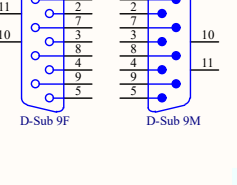
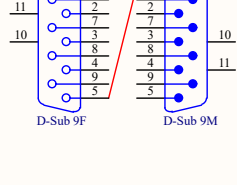
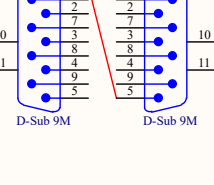
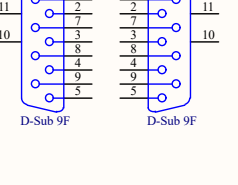
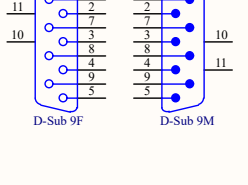
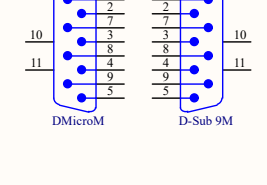
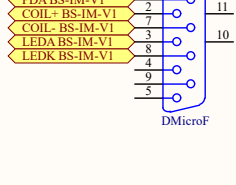
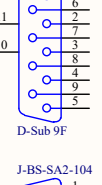
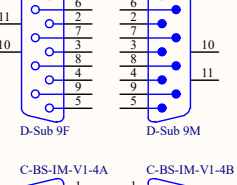
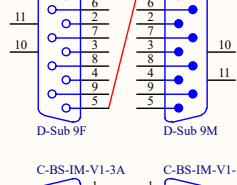
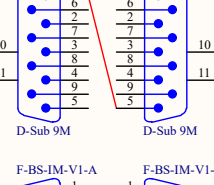
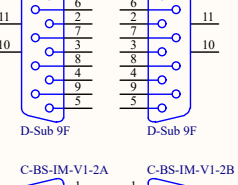
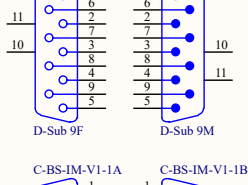
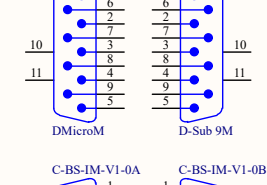
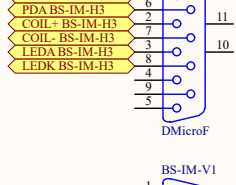
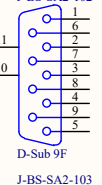
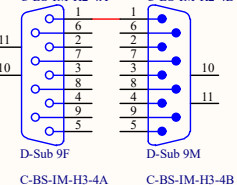
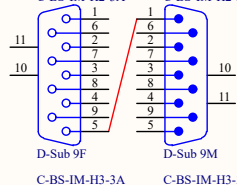
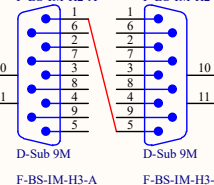
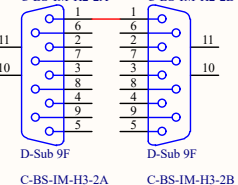
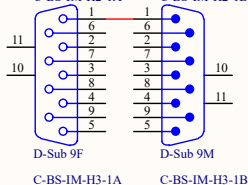
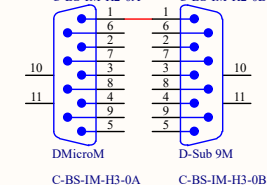
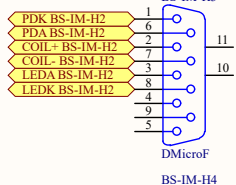
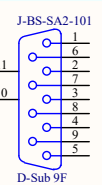
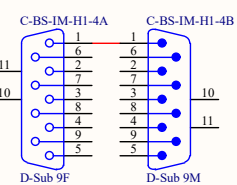
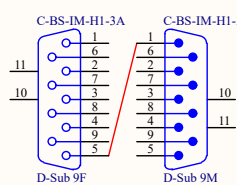
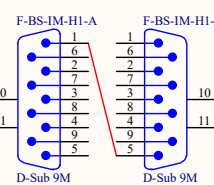
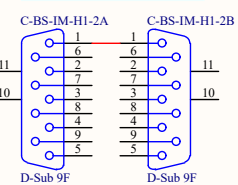
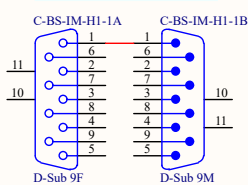
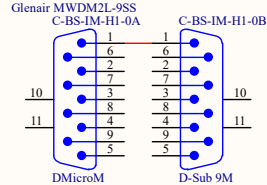
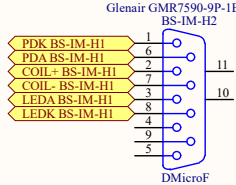

J-BS-SA3-103 and J-BS-SA3-104 not used

Title BS Suspension Cabling - Intermediate Mass OSEMs		
Size A3	Number JGW-D1503600	Revision -v7
Date: 2016/04/10	Sheet 7 of 14	
File: \\..02 IM OSEMs.SchDoc	Drawn By:	

1 Feedthrough

IM Picomotors

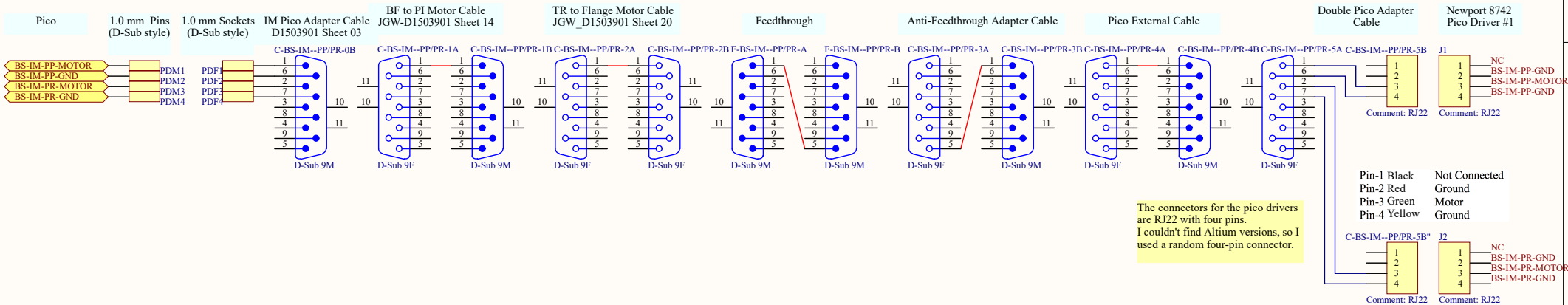

Title BS Suspension Cabling - Intermediate Mass Picos			
Size A3	Number JGW-D1503600	Revision -v7	
Date: 2016/04/10	Sheet 3 of 14	Drawn By:	
File: \\...03 IM Picos.SchDoc			

BF and SF Picomotors and Steppers

3 Feedthroughs

Pin-1 Black Not Connected
 Pin-2 Red Ground
 Pin-3 Green Motor
 Pin-4 Yellow Ground

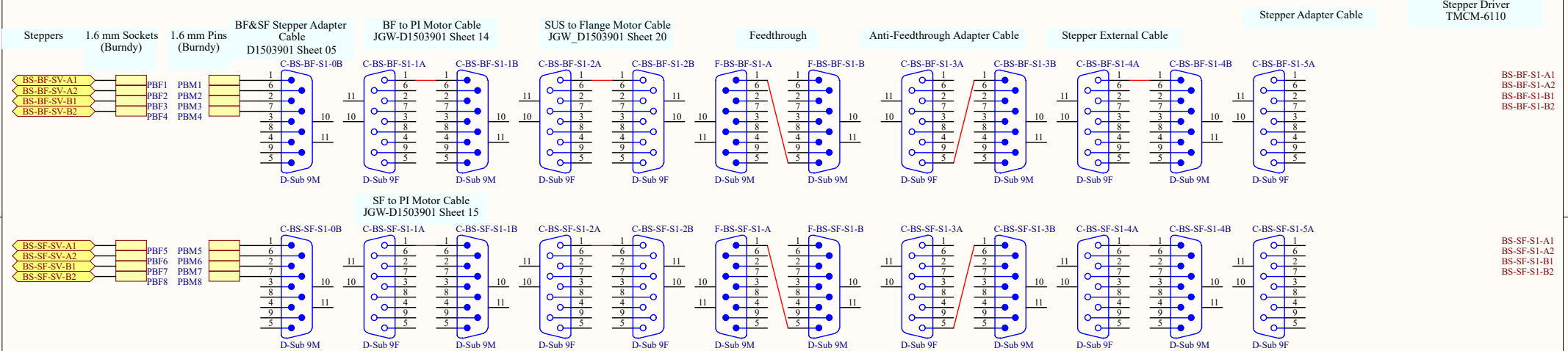
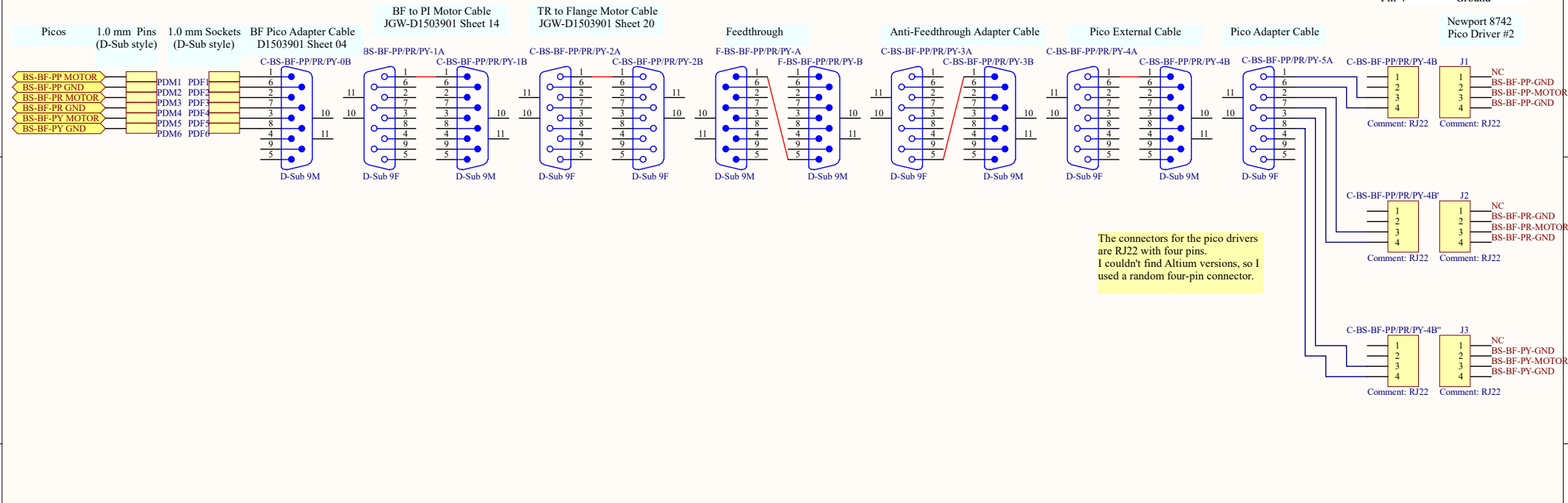

Title			BS Suspension Cabling - Bottom and Standard Filter Picos/Steppers		
Size	Number	JGW-D1503600		Revision	-v7
A3					
Date:	2016/04/10	Sheet 4 of 14			
File:	\\.\04 BF&SF Picos&Steppers.SchDoc	Drawn By:			

BF and SF LVDT/ACTs

2 Feedthroughs

LVDT/ACT Distributor
JGW-D1402124,
Front Panel
JGW-D1402827
Board
JGW-D1402117 #2

LVDT/Act

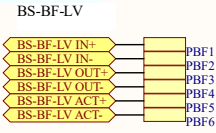

BF&SF LVDT Adapter Cable
JGW-D1503901 Sheet 06

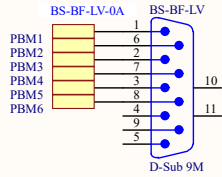

BF-PI Signal Cable
JGW-D1503901 Sheet 08

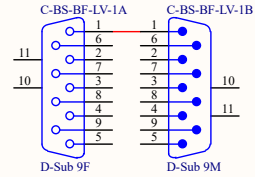

SUS-Flange Signal Cable
JGW_D1503901 Sheet 19

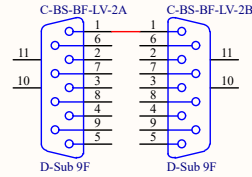

Feedthrough

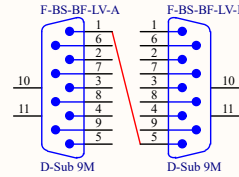

Feedthrough Adapter Cable

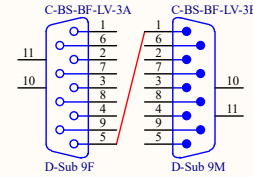

External Cable

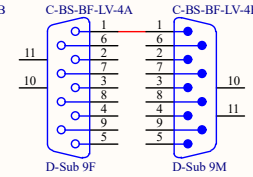

Ch 4

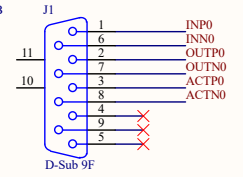

J-BS-LA-6 and J-BS-LA-7 not used

LVDT/Act

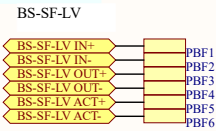

BF&SF LVDT Adapter Cable
JGW-D1503901 Sheet 06

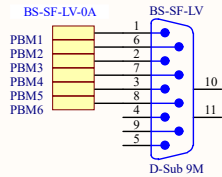

SF-PI Signal Cable
JGW-D1503901 Sheet 09

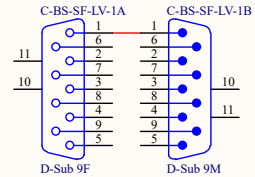

SUS-Flange Signal Cable
JGW_D1503901 Sheet 19

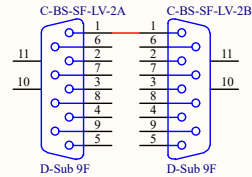

Feedthrough

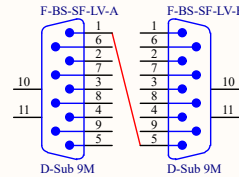

Feedthrough Adapter Cable

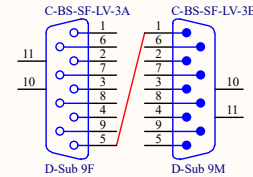

External Cable

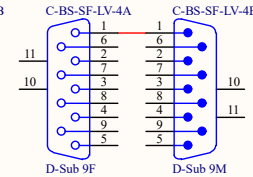

Ch 5

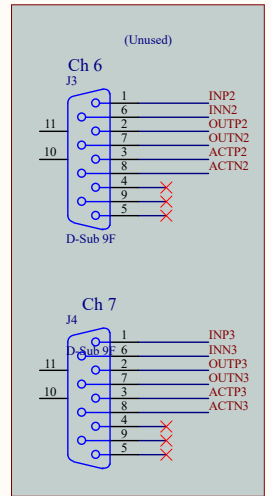
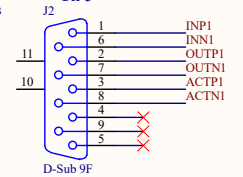

Title			
BS Suspension Cabling - Bottom and Standard Filter LVDTs			
Size	Number	Revision	
A3	JGW-D1503600	-v7	
Date:	2016/04/10	Sheet 5of 14	
File:	\\.\05 BF&SF LVDTs.SchDoc	Drawn By:	

4 Feedthroughs

Preisolator LVDT/ACTs

LVDT/ACT

OPTIONAL
Signal Cable Extension
JGW_D1503901 Sheet 10

TR-Flange Signal Cable
JGW_D1503901 Sheet 19

Feedthrough

Anti-Feedthrough Adapter Cable

LVDT/ACT External Cable

LVDT/ACT Distributor
JGW-D1402124,
Front Panel
JGW-D1402827
Board
JGW-D1402117 #1

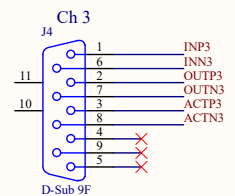
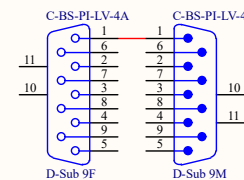
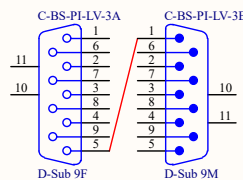
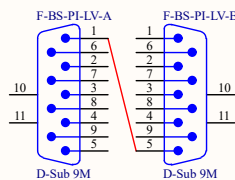
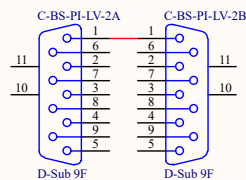
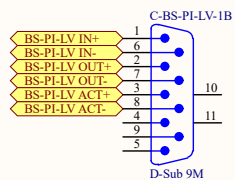
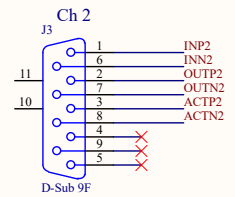
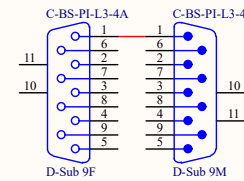
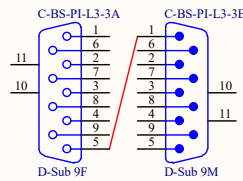
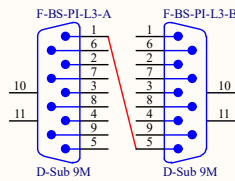
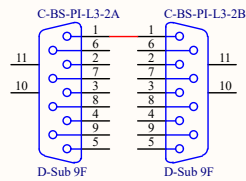
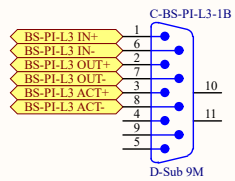
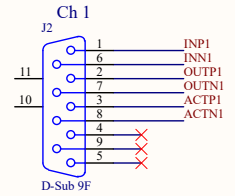
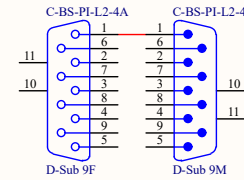
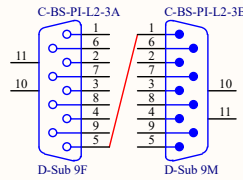
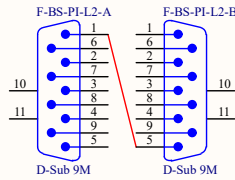
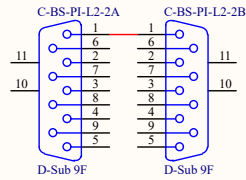
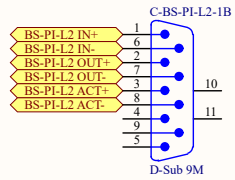
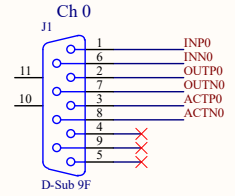
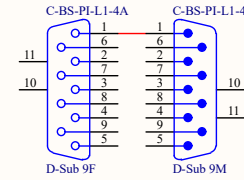
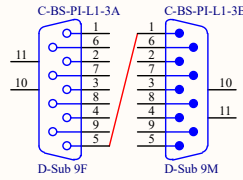
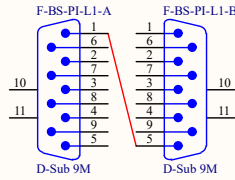
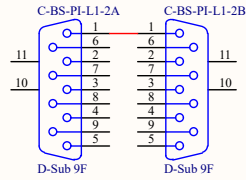
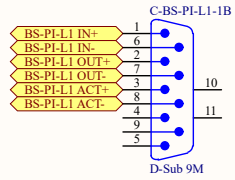

LVDT-COIL

Pin	Function
1	LVDT IN P
2	LVDT OUT P
3	COIL P
4	
5	
6	LVDT IN N
7	LVDT OUT N
8	COIL N
9	

Title		
BS Suspension Cabling - Preisolator LVDT/Actuators		
Size	Number	Revision
A3	JGW-D1503600	-v7
Date:	2016/04/10	Sheet 6of 14
File:	\\.\06 PI LVDTs.SchDoc	Drawn By:

4 Feedthroughs

Preisolator Steppers

Stepper

PI Stepper Adapter
JGW-D1503901 Sheet 24

OPTIONAL

Motor Cable Extension
JGW_D1503901 Sheet 16

TR to Flange Motor Cable
JGW-D1503901 Sheet 20

Feedthrough

Anti-Feedthrough Adapter Cable

Stepper External Cable

Stepper Splitter Cable
Double Motor Version

TMCM-6110
Stepper Driver #2

C10104S0000
CVIlux C101 series,
4 pins, 2mm pitch

C10104PIVK0-LF
CVIlux C101 series,
4 pins, 2mm pitch

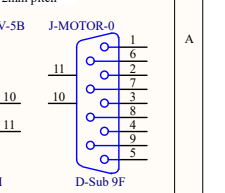
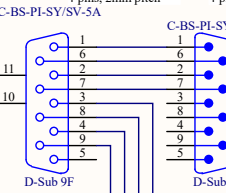
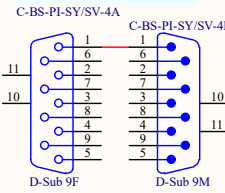
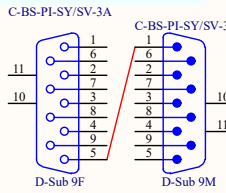
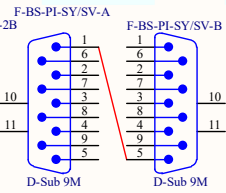
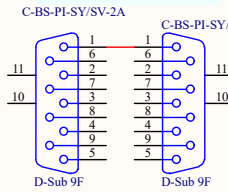
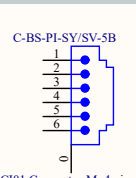
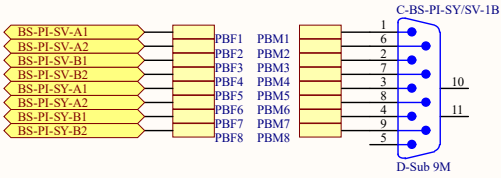

The vertical and yaw steppers have no limit switches and are combined on a single cable that VIS needs to provide.

The horizontal steppers have limit switches and will be wired as indicated by the IP manufacturer.

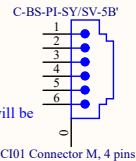

PI to Flange Motor Cable
JGW-D1503901 Sheet 13

Pin	Label	Direction	Description
1	A1	Output	Pin 1 of motor coil A
2	A2	Output	Pin 2 of motor coil A
3	B1	Output	Pin 1 of motor coil B
4	B2	Output	Pin 2 of motor coil B

Controller motor inputs.

Stepper Splitter Cable
Motor+Switch Version

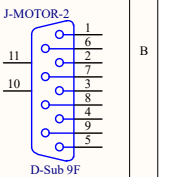
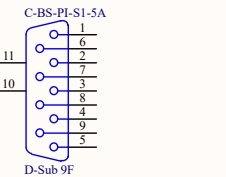
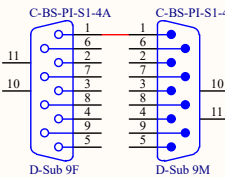
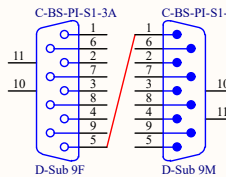
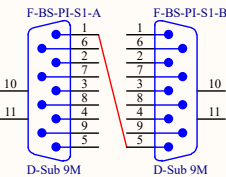
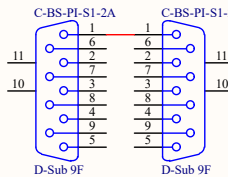
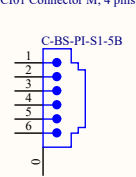
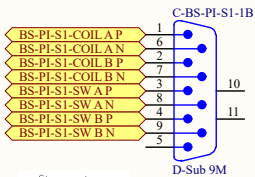

Pin	Function
1	COIL A P
2	COIL B P
3	Switch 1 P
4	Switch 2 P
5	
6	COIL A N
7	COIL B N
8	Switch 1 N
9	Switch 2 N

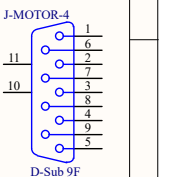
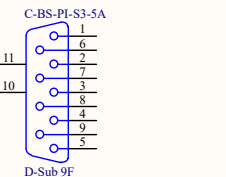
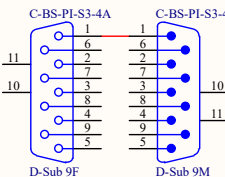
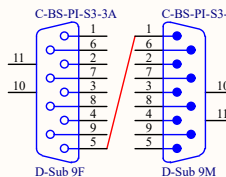
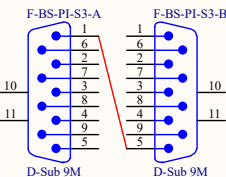
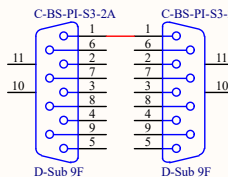
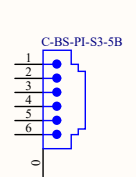
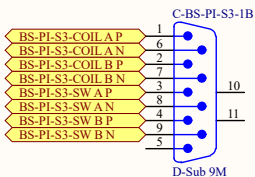
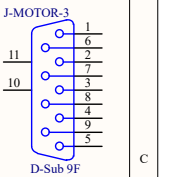
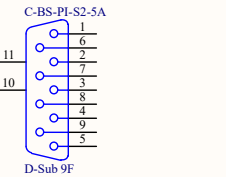
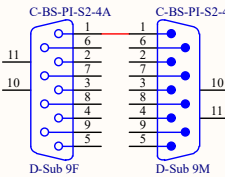
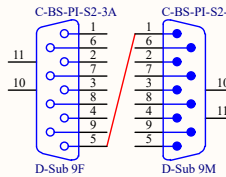
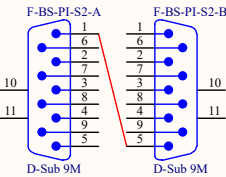
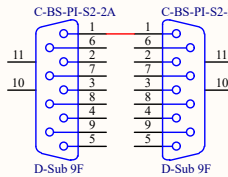
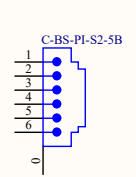
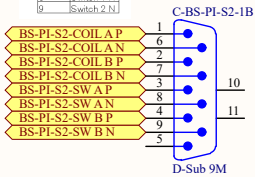

Title		
BS Suspension Cabling - Preisolator Steppers		
Size	Number	Revision
A3	JGW-D1503600	-v7
Date:	2016/04/10	Sheet 7 of 14
File:	\\..07 PI Steppers.SchDoc	Drawn By:

3 Feedthroughs

Preisolator Geophones

Geophone Pod Internal Cabling
(same for all three pods):

Pod #1: geophone L400002322, preamp 15
Pod #2: geophone L400002321, preamp 12
Pod #3: geophone L400002323, preamp 14



Cannot open file
Z:\Work\KA
GRA\Electro
nics\Type B
Prototype

Geophone Pod

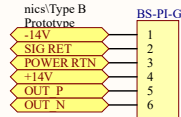

MIL C 26482 10-6 Male

Geophone Adapter Cable JGW-D1503901 Sheet 07

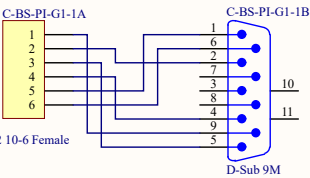

MIL C 26482 10-6 Female

PI to Flange Geophone Cable JGW-E1503901 Sheet 12

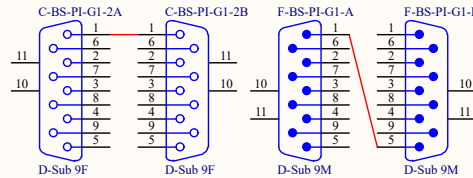

Feedthrough

Anti-Feedthrough Adapter Cable

Geophone External Cable

Geophone Distributor JGW-D1402120

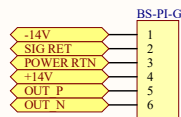
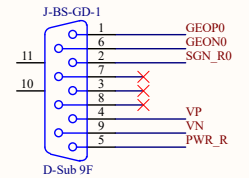

MIL C 26482 10-6 Male

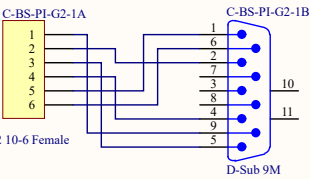

MIL C 26482 10-6 Female

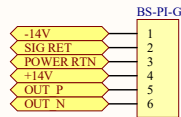
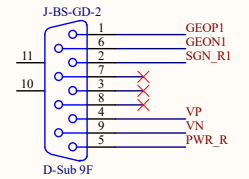
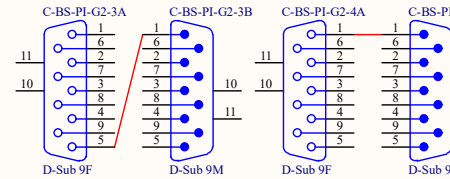
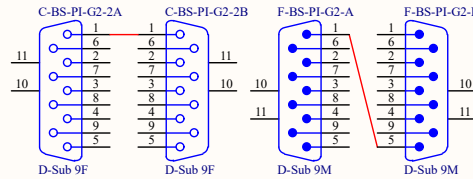

MIL C 26482 10-6 Male

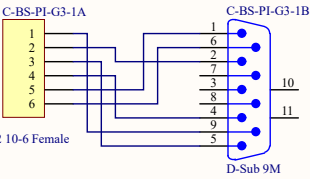

MIL C 26482 10-6 Female

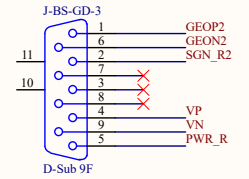
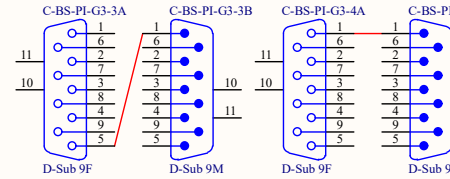
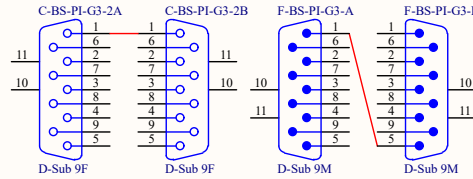

J-BS-GD-4 not used

Title BS Suspension Cabling - Preisolator Geophones		
Size A3	Number JGW-D1503600	Revision -v6
Date: 2016/04/10	Sheet 8 of 14	Drawn By:
File: \\.\08 PI Geophones.SchDoc		

OSEM Sat Amps and Drivers

Sat Amp Inputs from OSEMs (see Sheets 1&2)

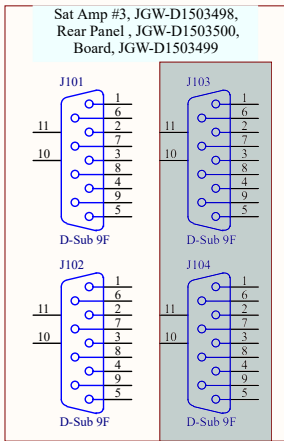
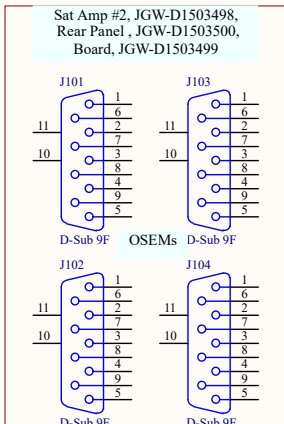
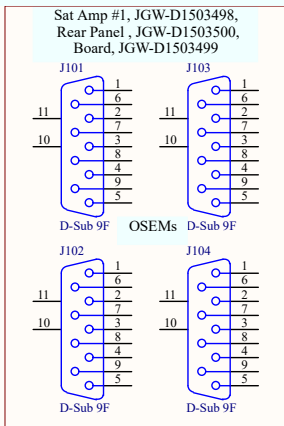

Sat Amp PD Outputs

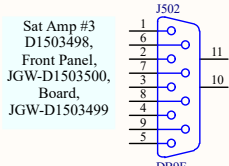
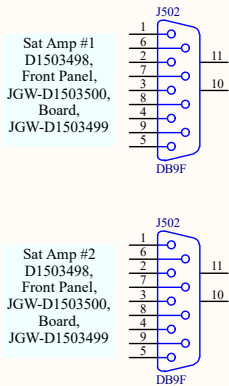

Sat Amp LED Current Monitor Outputs

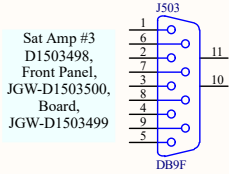
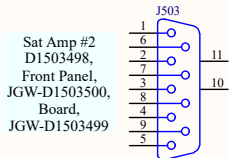
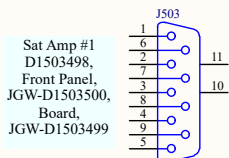

Generic D-Sub 9 Cable M-F

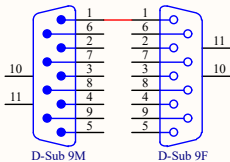
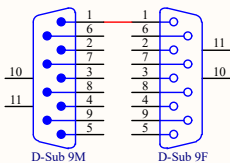
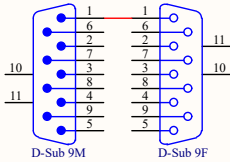

Generic D-Sub 9 Cable M-F

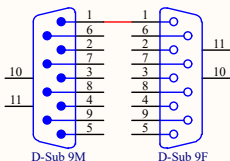
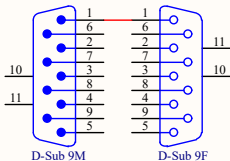
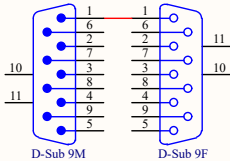

AA Chassis D1100621

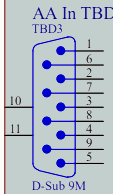
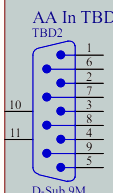
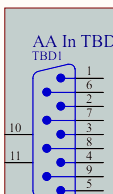
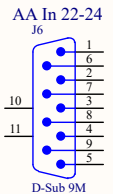
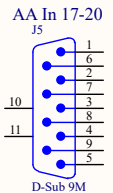
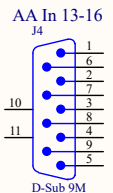

Sat Amp #1
JGW-D1503498,
Front,
JGW-D1503500,
Board,
JGW-D1503499

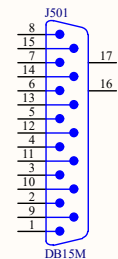

Sat Amp #2
JGW-D1503498,
Front,
JGW-D1503500,
Board,
JGW-D1503499

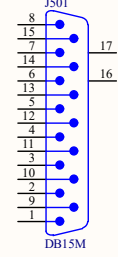

Sat Amp #3
JGW-D1503498,
Front,
JGW-D1503500,
Board,
JGW-D1503499

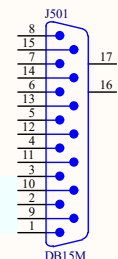

Sat Amp Coil Current Inputs

Low Power Coil Driver #1
JGW-D1503506,
Front Panel,
JGW-D1503508,
Board,
JGW-D1503507

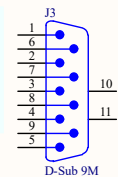

Low Power Coil Driver #2
JGW-D1503506,
Front Panel,
JGW-D1503508,
Board,
JGW-D1503507

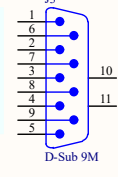

Low Power Coil Driver #3
JGW-D1503506,
Front Panel,
JGW-D1503508,
Board,
JGW-D1503507

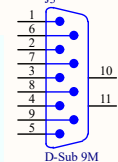

Coil Current Request Inputs

Generic D-Sub 15 Cable M-F

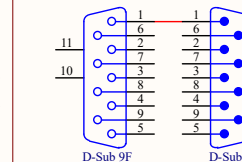
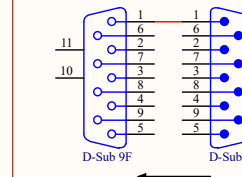
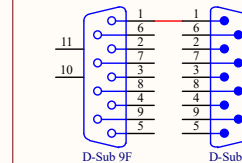
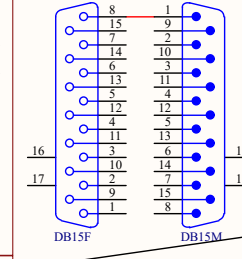
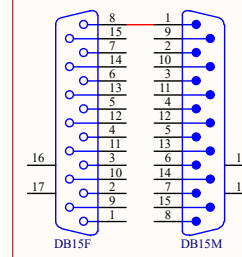
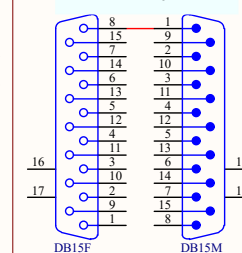

Generic D-Sub 9 Cable M-F

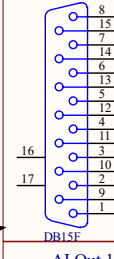
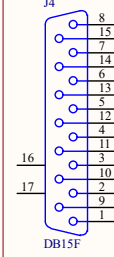
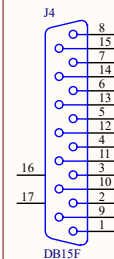

Low Power Coil Driver #1
JGW-D1503506,
Rear Panel,
JGW-D1503509,
Board,
JGW-D1503507

Low Power Coil Driver #2
JGW-D1503506,
Rear Panel,
JGW-D1503509,
Board,
JGW-D1503507

Low Power Coil Driver #3
JGW-D1503506,
Rear Panel,
JGW-D1503509,
Board,
JGW-D1503507

AI Out 1-4

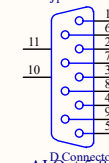

AI Out 5-8

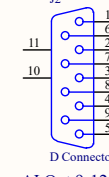

AI Out 9-12

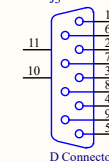

Title			BS Suspension Cabling - OSEM Sat Amps & Drivers		
Size	Number	JGW-D1503600		Revision	-v7
A3					
Date:	2016/04/10	Sheet 9 of 14			
File:	\\..09 Sat Amps & Coil Drivers.SchDoc	Drawn By:			

BS&SF LVDT Drivers

**Inputs from
BS&SF
LVDTs
(see Sheet 5)**

LVDT/ACT Distributor
JGW-D1402124,
Rear Panel
JGW-D1402828,
Board
JGW-D1402117 #2

Ch 4-7 LVDT-IN

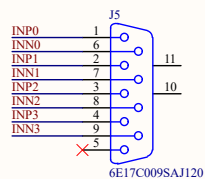

LVDT/ACT Distributor
JGW-D1402124,
Front Panel
JGW-D1402827
Board
JGW-D1402117 #2

Ch 4

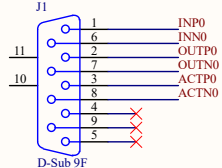

Ch 5

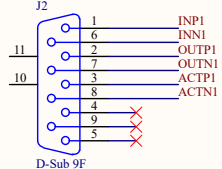

**2 inputs
unused**

Ch 6
Ch 7

Ch 4-7 LVDT-OUT

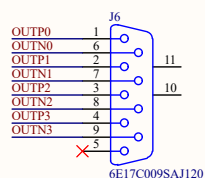

Ch 4-7 ACT

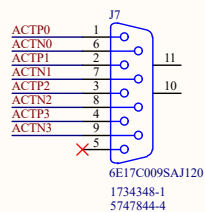

Generic D-Sub 9 Cable M-F

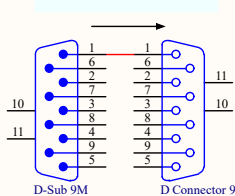

Generic D-Sub 9 Cable M-F

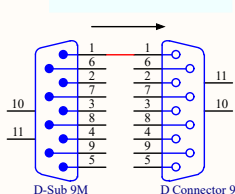

LVDT-Coil Driver Cable

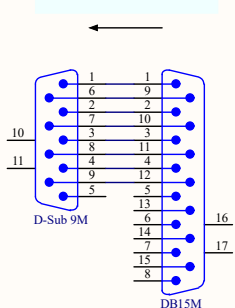

LVDT Driver Chassis
JGW-D1402826,
Front Panel
JGW-D1402827
Input Board #2
JGW-D1301467

LVDT Driver Chassis
JGW-D1402826,
Front Panel
JGW-D1402827
Main Board
JGW-D1301467

LVDT MAIN (Right)

LVDT CARD 2 (Left)

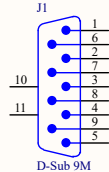
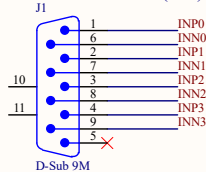

LVDT CARD 2 (Right)

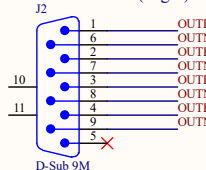

High Power Coil Driver #2
JGW-D1503504,
Rear Panel,
JGW-D1503505,
Monitor Board
JGW-D1503510

High Power Coil Driver #1
JGW-D1503504,
Front Panel,
JGW-D1503502,
Driver Board
JGW-D1503503

Gender Bender F-F

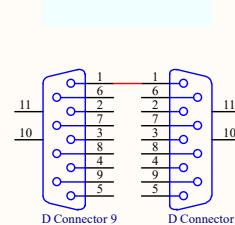

Generic D-Sub 9 Cable M-F

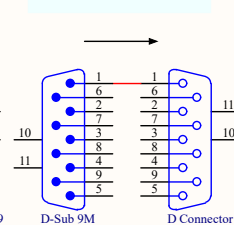

AA Chassis
JGW-D1100621

AA In 9-12

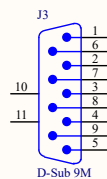

Generic D-Sub 9 Cable M-F

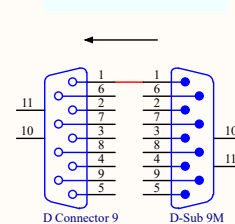

AI Chassis #2
D1101521

AI Out 1-4

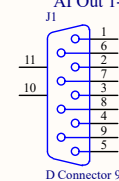

Signal Generator
10 kHz, 5 V

J7

BNC

The LVDT Chassis has provision for an oscillator card, but until such time as the cards are available, an external oscillator will be required

Cable

LVDT Driver Chassis
JGW-D1402826,
Front Panel
JGW-D1402827
Interface Board
JGW-D1402829



DIST-OUT4
LEMO I Pin

Title BS Suspension Cabling - BS&SF LVDT Drivers		
Size A3	Number JGW-D1503600	Revision -v7
Date: 2016/04/10	Sheet of 10	Sheet of 14
File: \\.\10 BS&SF LVDT Drive.SchDoc	Drawn By:	

**Inputs from PI LVDTs
(see Sheet 6)**

LVDT/ACT Distributor
JGW-D1402124,
Rear Panel
JGW-D1402828,
Board
JGW-D1402117 #1

LVDT/ACT Distributor
JGW-D1402124,
Front Panel
JGW-D1402827
Board
JGW-D1402117 #1

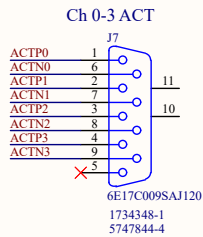
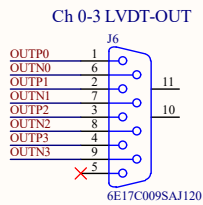
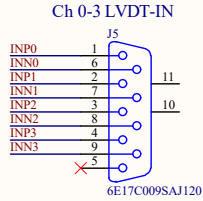
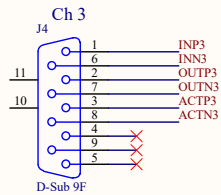
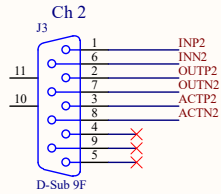
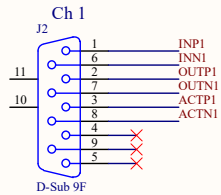
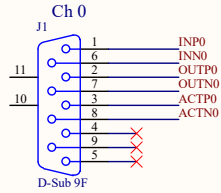

PI LVDT Drivers

LVDT Driver Chassis
JGW-D1402826,
Front Panel
JGW-D1402827
Input Board #1
JGW-D1301467

LVDT Driver Chassis
JGW-D1402826,
Front Panel
JGW-D1402827
Main Board
JGW-D1301467

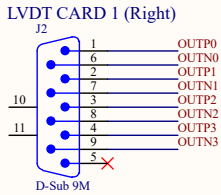
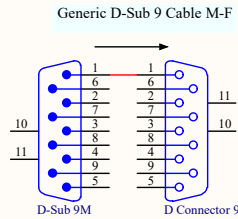
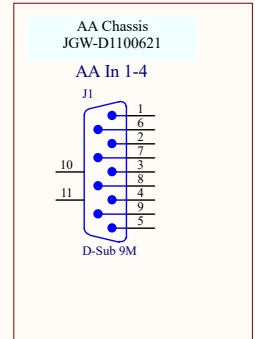
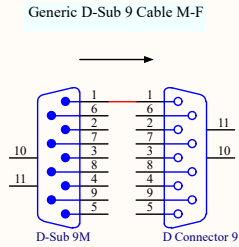
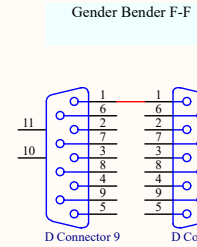
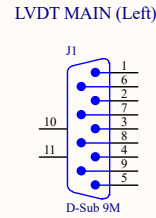
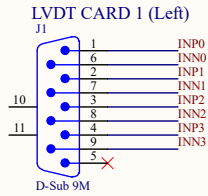
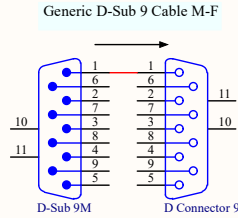

LVDT-Coil Driver Cable

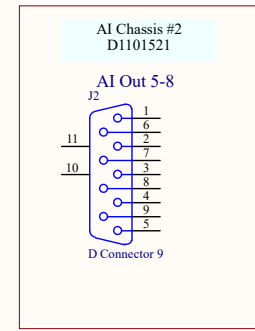
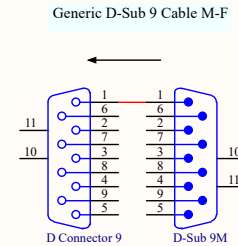
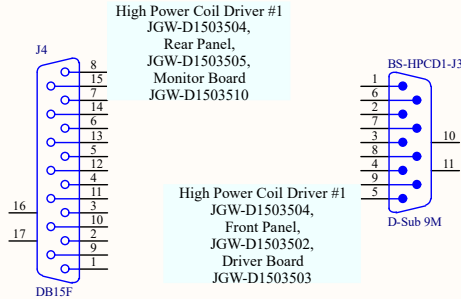
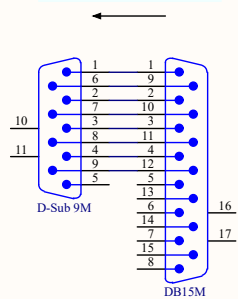

Title		
BS Suspension Cabling - PI LVDT Drivers		
Size	Number	Revision
A3	JGW-D1503600	-v7
Date:	2016/04/10	Sheet of 14
File:	\\M11 PI LVDT Drive.SchDoc	Drawn By:

Pico and Stepper Drivers

Stepper Driver #2
JGW-D1600TBD
Board
TMCM-6110
Serial-Internet Converter
MOXA

**BOX STILL IN DESIGN!!!
GUESS AT FINAL PINOUT!!!**

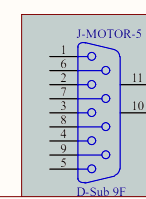
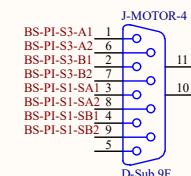
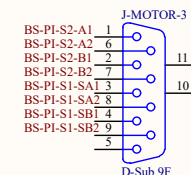
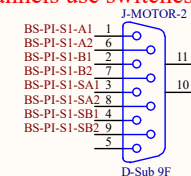
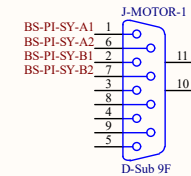
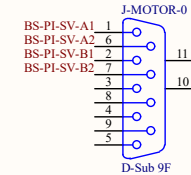

Outputs to PI
Steppers
(see Sheet 7)

NOTE: 3 channels use switches

Outputs to
IM Picos
(see Sheet 3)

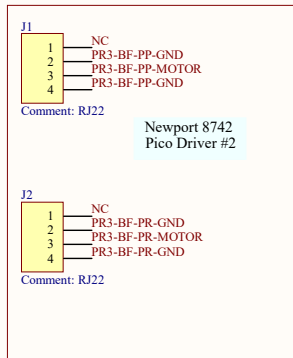
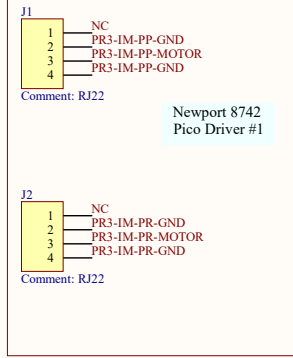

The connectors for the pico drivers are RJ22 with four pins. I couldn't find Altium versions, so I used a random four-pin connector.

Outputs to
BF Picos
(see Sheet 4)

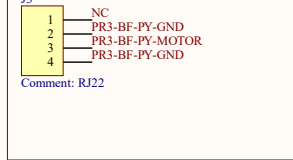

Output to BF
Stepper
(see Sheet 4)

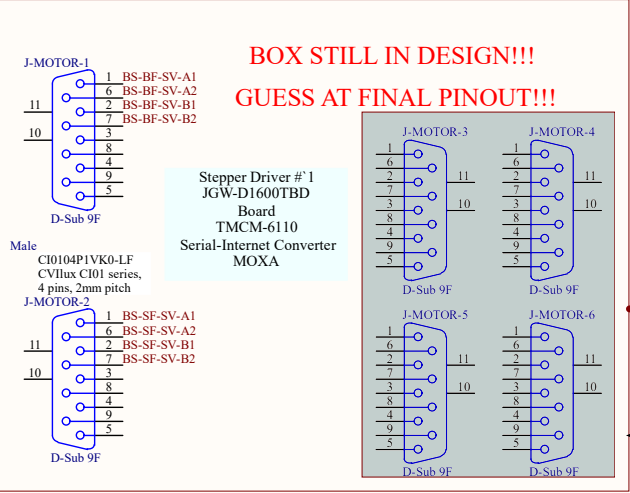

Output to SF
Stepper
(see Sheet 4)

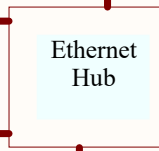

AC

AC

AC

AC

Title			BS Suspension Cabling - Pico and Stepper Drivers		
Size	Number			Revision	
A3	JGW-D1503600	12			-v7
Date:	2016/04/10	Sheet of		14	
File:	\\.\12 Pico&Stepper Drive.SchDoc	Sheet of		14	Drawn By:

3 Feedthroughs

Geophone Readout

Inputs from PI Geophones (see Sheet 8)

Geophone Distributor
D1402120
Front Panel
D1402122
Board
D1402121

Geophone Distributor
D1402120
Rear Panel
D1402123
Board
D1402121

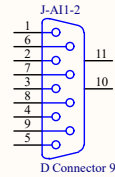
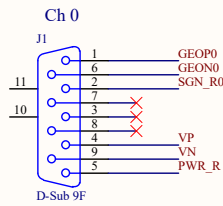

Generic D-Sub 9 Cable M-F

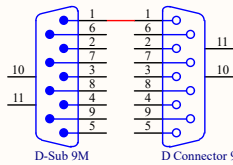

AA Chassis
JGW-D1100621

AA In 5-8

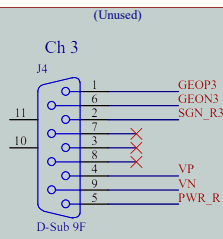
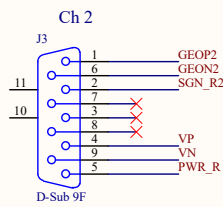
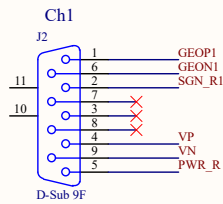
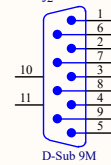

Title			BS Suspension Cabling - Geophone Readout		
Size	Number	Revision			
A3	JGW-D1503600	14	-v6		
Date:	2016/04/10	Sheet	of	14	
File:	\\.\13 Geophone Readout.SchDoc	Drawn By:			

OpLev

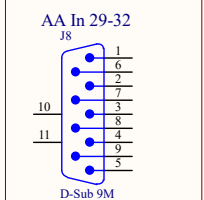
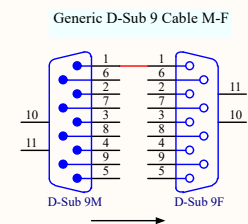
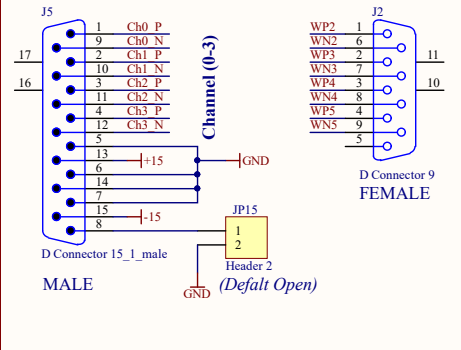
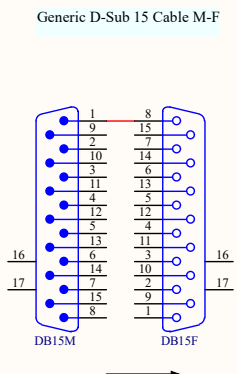
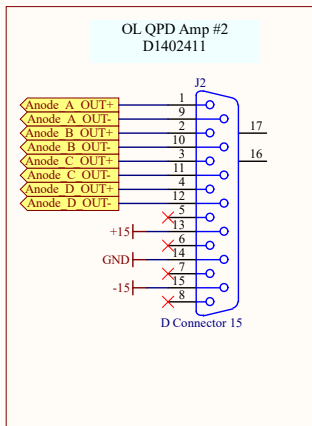
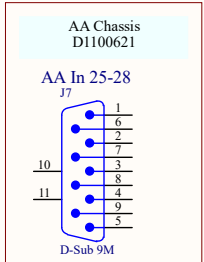
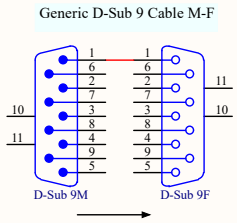
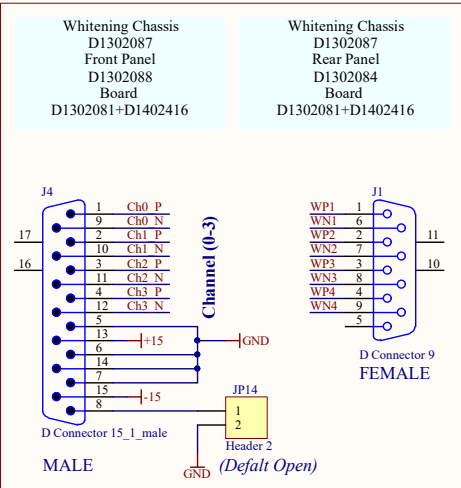
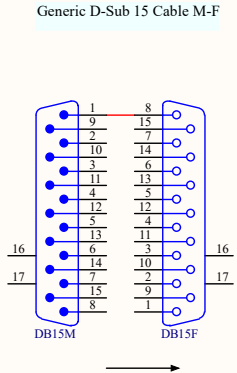
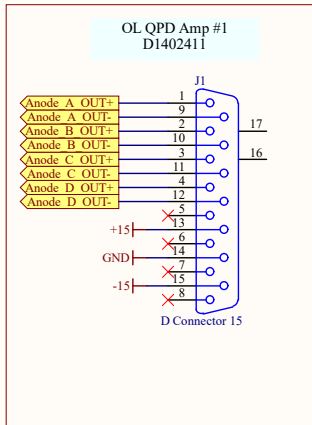

Title			BS Suspension Cabling - OpLev		
Size	Number			Revision	
A3	JGW-D1503600			-v7	
Date:	2016/04/10	Sheet	of	14	
File:	\\.\14 OpLev Readout.SchDoc	Drawn By:			