



# The Input Optics for iKAGRA

---

Masayuki Nakano

# Contents

- Background
- Overview of iKAGRA input optics
- Summary of PSL test in ICRR
- IOO Installation in the KAGRA tunnel
- Future Plan

# Contents

- **Background**
- Overview of iKAGRA input optics
- Summary of PSL test in ICRR
- IOO Installation in the KAGRA tunnel
- Future Plan

# Background

We are developing the input optics for **iKAGRA**. iKAGRA specifications are below.

- **Configuration**
  - ✓ 3 km Fabry Perot Michelson Interferometer
- **Laser Power**
  - ✓ 2W
- **Purpose**
  - ✓ To gain experience in operating a large interferometer

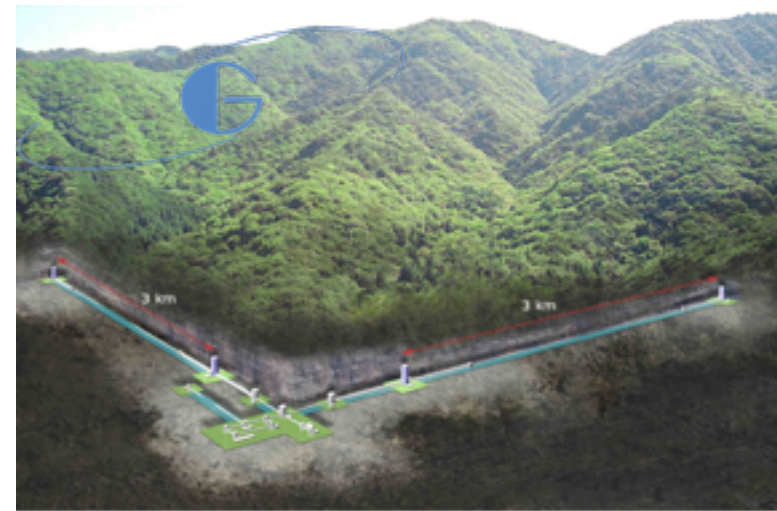

# Objectives of Input Optics

- Provide a laser beam stable enough for locking the Fabry-Perot Michelson Interferometer stably.
  - ✓ **Frequency stability**
  - ✓ **Reduction of the beam jitter**
  - ✓ **Mode matching**

# Contents

- Background
- **Overview of iKAGRA input optics**
- Summary of PSL test in ICRR
- IOO Installation in the KAGRA tunnel
- Future Plan

# Overview of iKAGRA input optics

- **In-air optics**

- ✓ A Laser Source
- ✓ EOMs for IMC and MIF control
- ✓ Steering mirrors (SMs) for align the beam
- ✓ The frequency stabilization system with FRC
- ✓ IMC mode matching lenses

- **In-vacuum optics**

- ✓ 53 m long Input Mode Cleaner (IMC)
- ✓ A vacuum compatible high power faraday isolator
- ✓ An Input Mode Matching Telescope

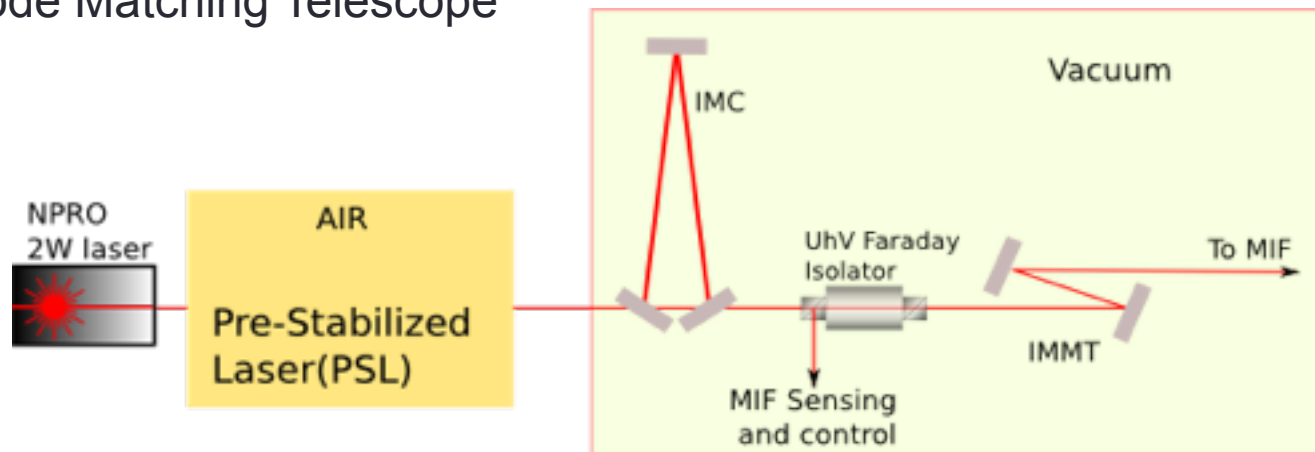

# Pre-Stabilized Laser (PSL)

- Laser Source
  - ✓ A monolithic Nd:YAG crystal NPRO (Non-Planar Ring Oscillator) laser.
  - ✓ The power is 2 W
- Pre-mode cleaner (PMC)
  - ✓ The cavity length will be controlled with a PZT on the end mirror by Pound-Driver Hall signal.
  - ✓ 40 cm long triangular cavity.

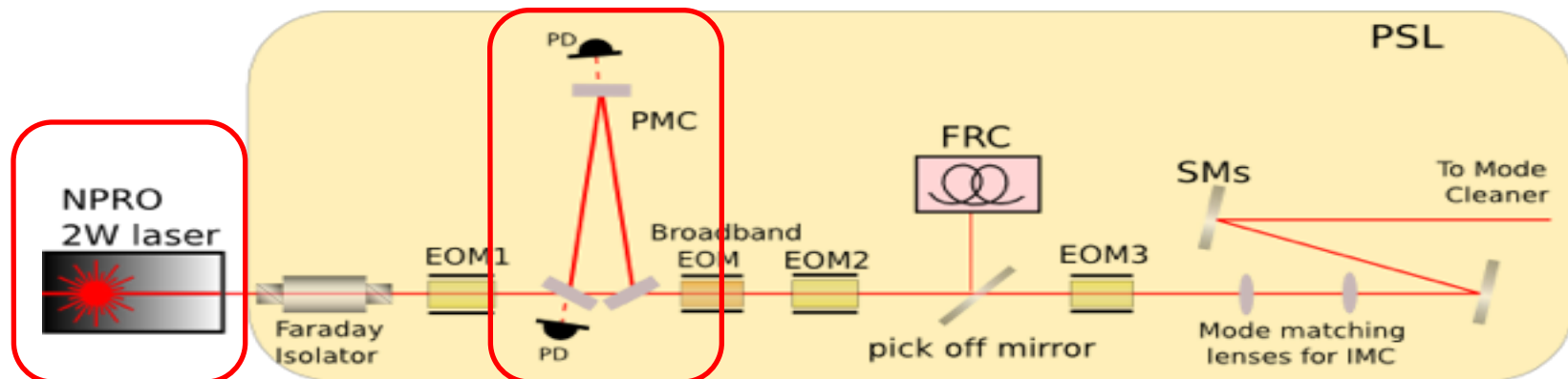

Fig.2 Pre-Stabilized Laser

# Pre-Stabilized Laser (PSL)

- Electro-optic Modulators (EOMs)
  - ✓ Providing the phase modulations for each cavity length control
    - EOM1 : For PMC
    - EOM2 : For FRC and IMC
    - EOM3 : For main interferometer
    - Broadband EOM : For frequency stabilization
- Fiber Ring Cavity (FRC)
  - ✓ Used for frequency stabilization as a reference cavity.

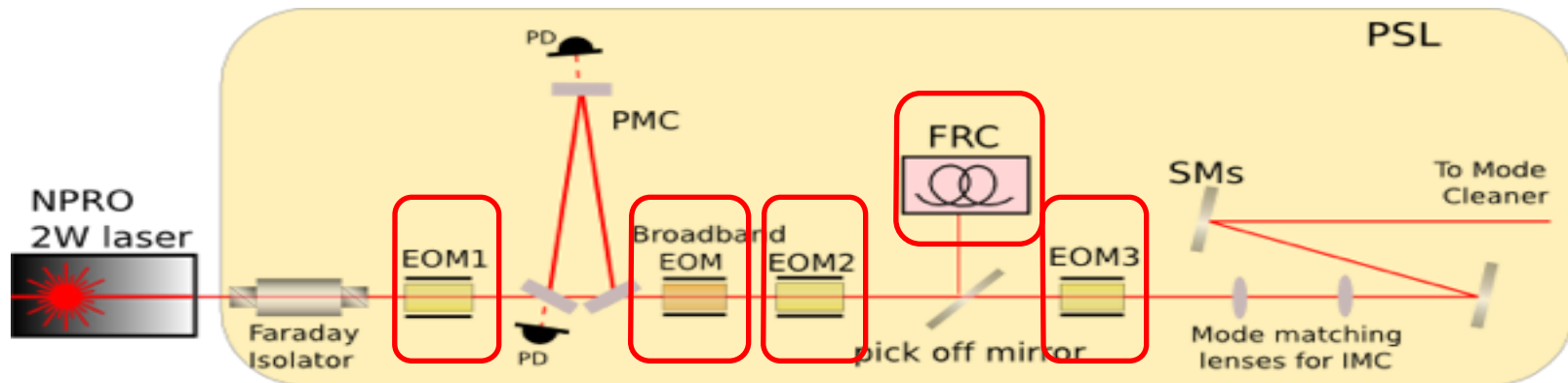
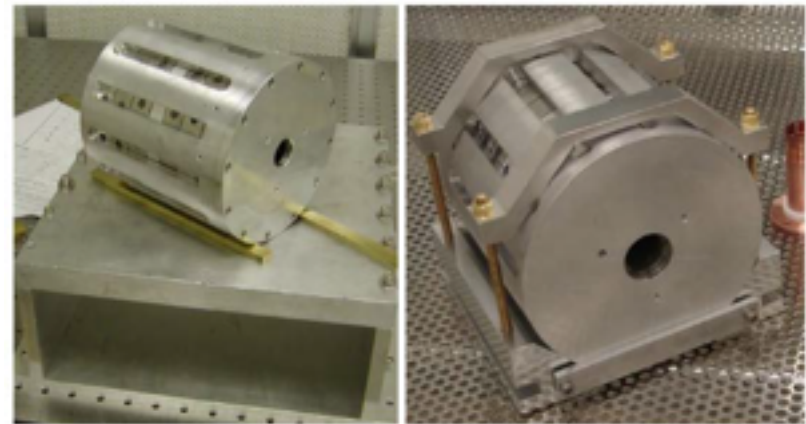

Fig.2 Pre-Stabilized Laser



# IMC, IFI, IMMT

- Input Mode Cleaner (IMC)
  - A triangular cavity with suspended mirrors.
  - Round trip length is 53 m, Finesse is 500, FSR is 5.625 MHz
  - Use the Wave Front Sensing technique for alignment control
- Input Faraday Isolator (IFI)
  - ✓ Vacuum compatible high isolation ratio.
  - ✓ We don't have to suspend it in the sense of phase noise caused by back scattered light
  - ✓ We ordered to Florida University.
- Mode Matching Telescope
  - ✓ We don't need any curved mirrors or lenses for mode matching for the FPMT.
  - ✓ We just use flat mirrors for the mode matching telescope.



# Contents

- Background
- Overview of iKAGRA input optics
- **Summary of PSL test in ICRR**
- IOO Installation in the KAGRA tunnel
- Future Plan

# Pre-Mode Cleaner

- ✓ cavity length : 40 cm
- ✓ The cavity frequency following to the laser frequency by the PDH control. An actuator is a PZT attached on the end mirror.

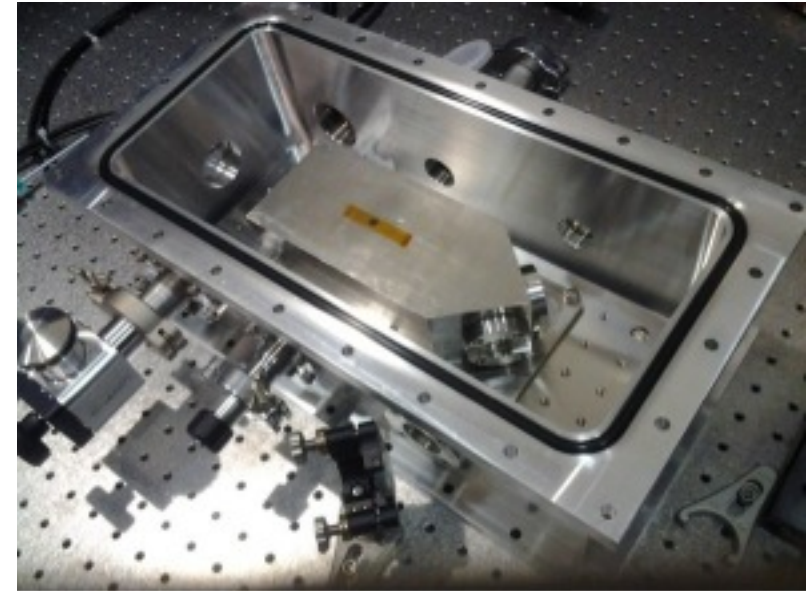
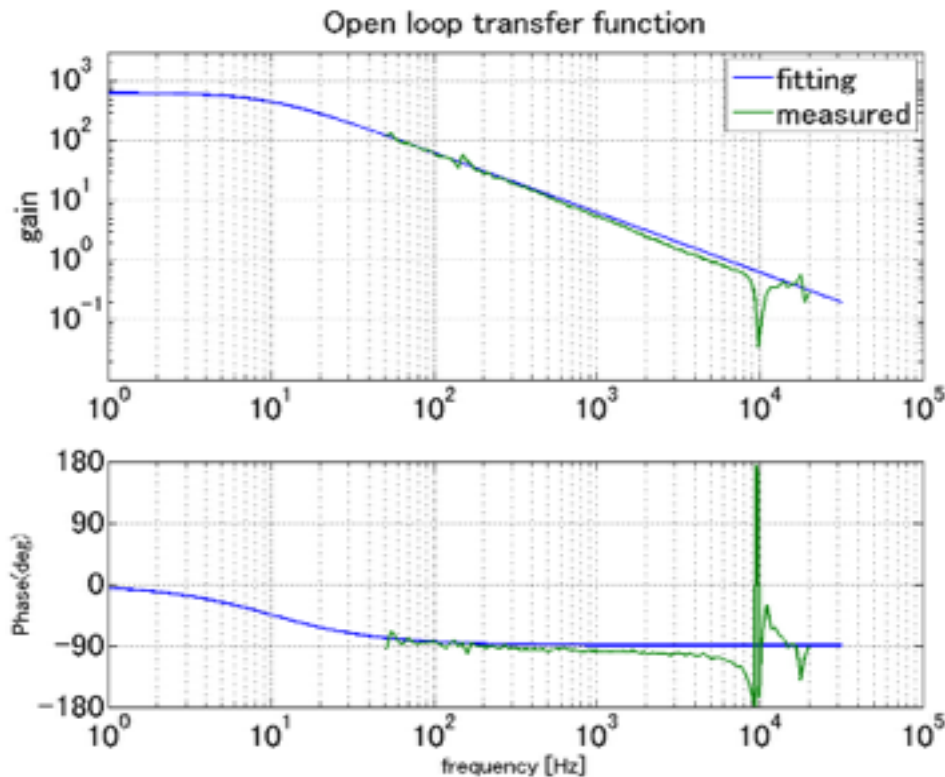

- ✓ UGF:4.2kHz
- ✓ The lock itself is stable, but the dynamic range of the PZT is not large enough.
- ✓ We have to make it larger somehow (change PZT, temperature control, etc.)

# Fiber Ring Cavity (FRC)

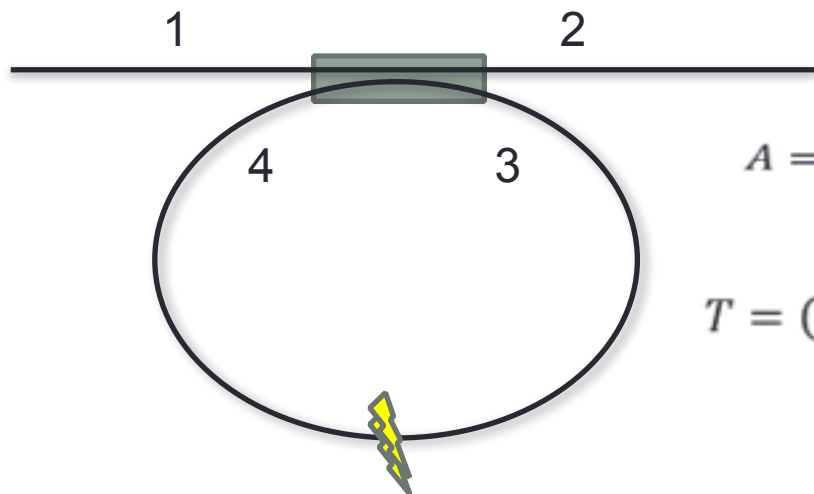

$$A = (1 - \kappa)(1 - r)(1 - a) e^{-2\alpha L}; \text{ loss factor}$$

$$T = (1 - r) \left( 1 - \frac{\kappa (1 - \kappa - A)}{(1 - \kappa) (1 + A - 2A^{1/2} \cos[\beta L])} \right)$$

$$f_{\text{FSR}} = \frac{c}{nL}$$

$$\Delta\nu = \frac{c \sqrt{\frac{(1 - \sqrt{A})^2}{\sqrt{A}}}}{L n \pi}$$

$$\mathcal{F} = \frac{\pi}{\sqrt{\frac{(1 - \sqrt{A})^2}{\sqrt{A}}}}$$

$\kappa$  : Coupling Ratio  
 $r$  : Insertion Loss  
 $a$  : Splicing Loss  
 $\alpha$  : Fiber Loss  
 $L$  : Cavity Length  
 $\beta$  : Wave number

Ref. "All-single-mode fiber resonator", L.F. Stokes, et al., Opt. Lett. 7, 288 (1982).

# FRC Control

- ✓ cavity length : 5.3m
- ✓ The laser frequency follows the cavity frequency of FRC with the PDH control. The actuators are laser temperature, laser PZT, broadband EOM.

Open loop transfer function

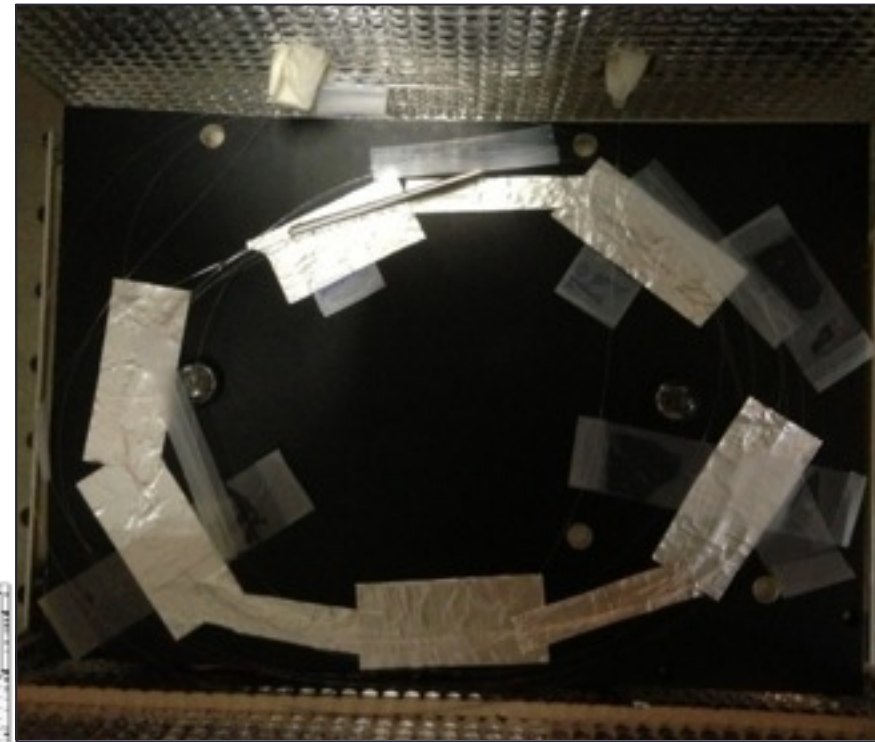
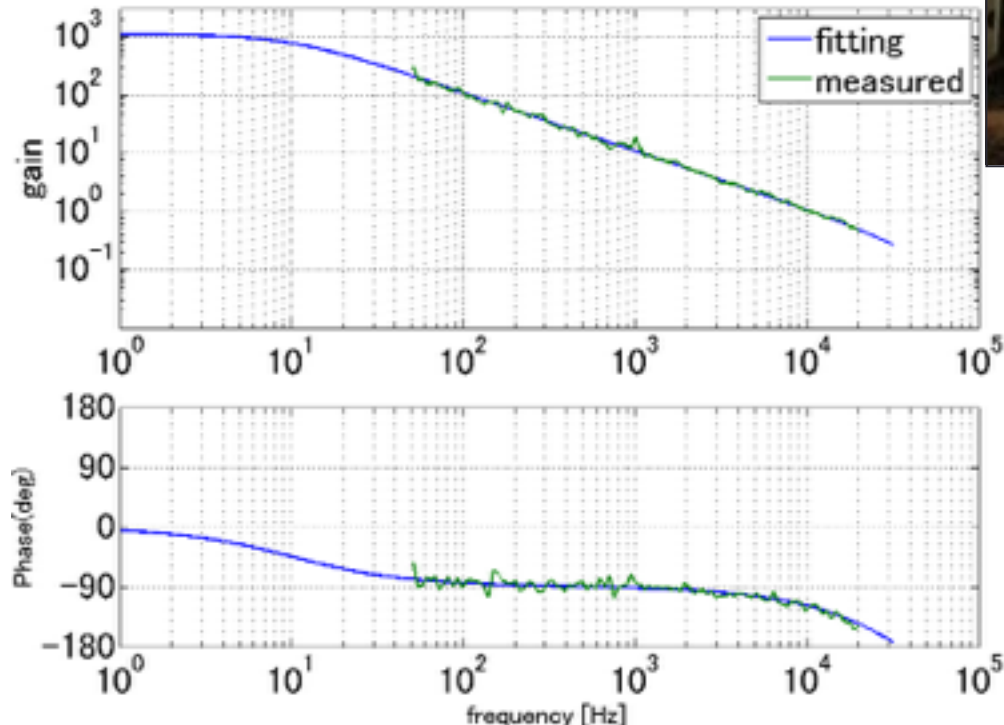

- ✓ UGF:10kHz
- ✓ Up to now, the broadband EOM haven't been installed yet. UGF might become faster after installing
- ✓ **The lock is not stable enough. (At most 2 hours).**

# Frequency Stabilization System(FSS) by FRC

- We tested the frequency stabilization system with FRC
- We used the PMC feedback signal as the frequency sensor.

- ✓ With FFS, laser frequency become more stable by factor of 2
- ✓ You can see the large noise around 1 kHz and 50 Hz HAM noise. The frequency stability would improve by hunting these noises.

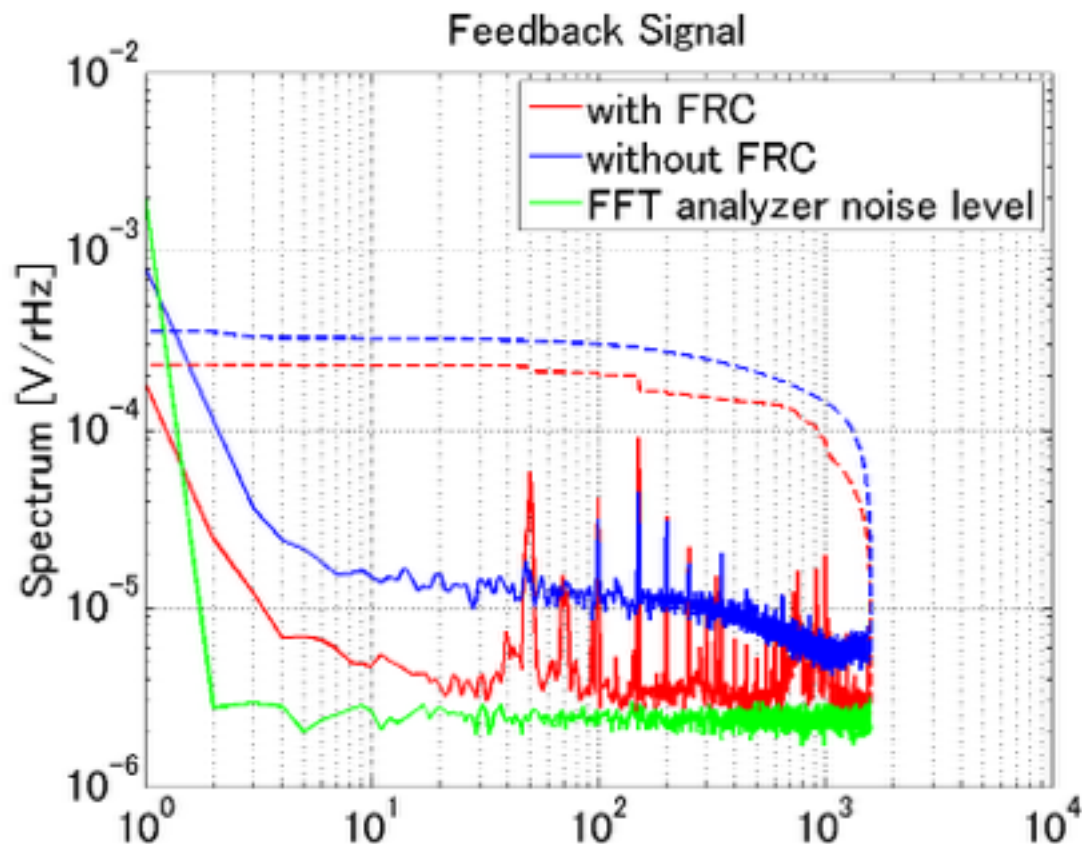

# Contents

- Background
- Overview of iKAGRA input optics
- Summary of PSL test in ICRR
- **IOO Installation in the KAGRA tunnel**
- Future Plan

# Laser room

- The Laser room is cleaned up so closely.
- We wear a clean suit in the laser room

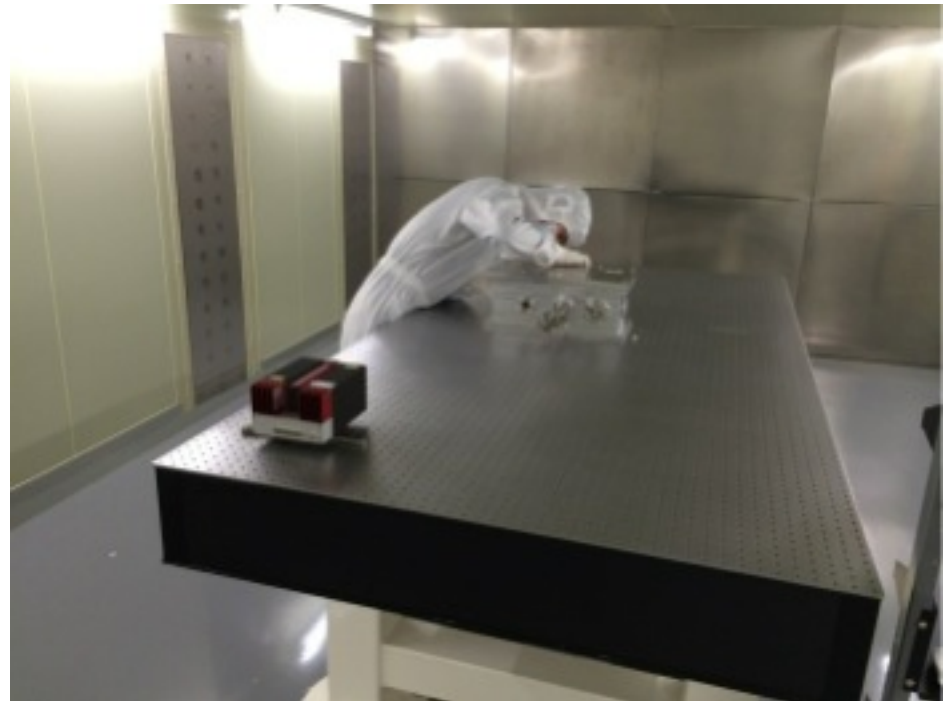



# PSL table

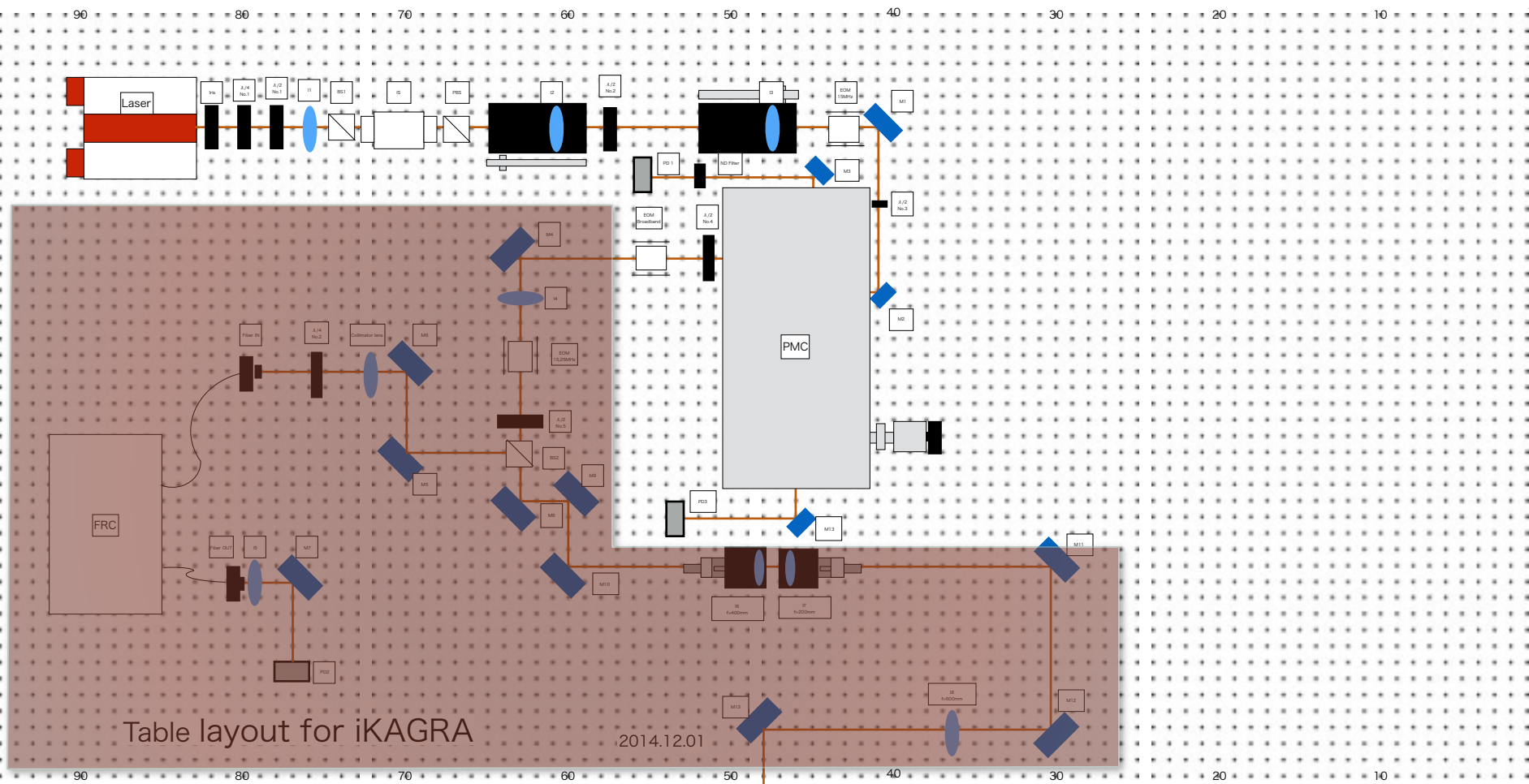

Table layout for iKAGRA

2014.12.01

Written by Kataoka (Tokyo Tech)

# PSL table

- The PMC is locked for **27 hours**.
- Unfortunately, the temperature stability in the room is not so good as our expectation. **That means we have to increase the dynamic range of the control.**

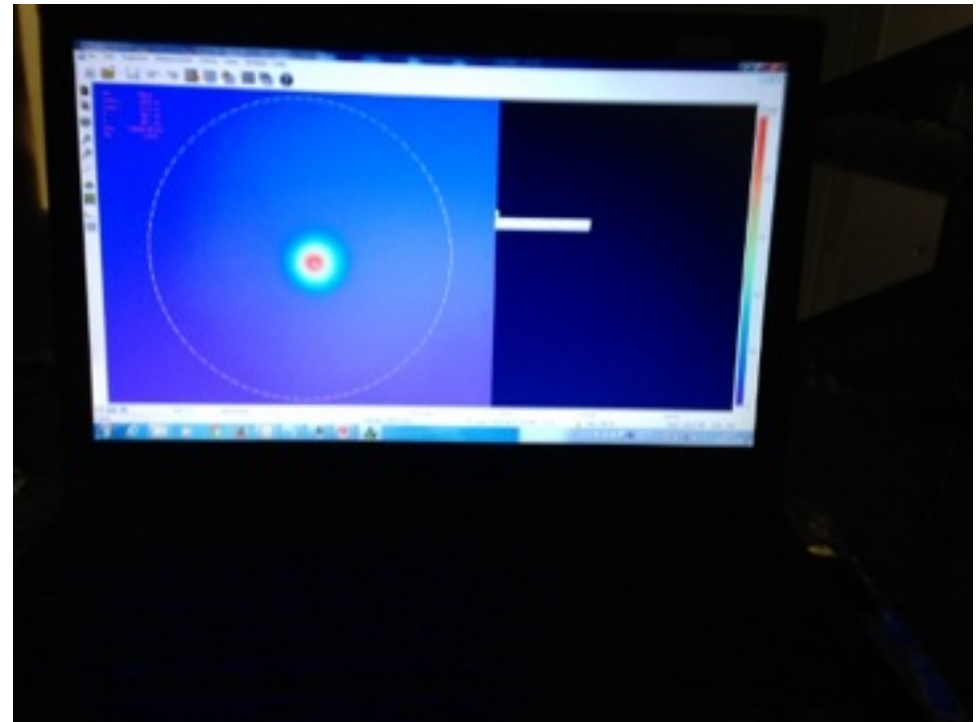
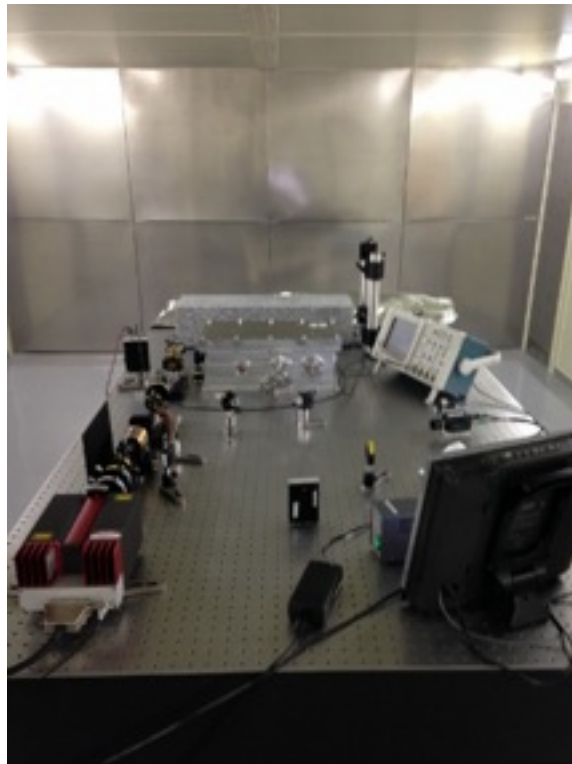

# Faraday Isolator

- The Faraday isolator is under assembling on the PSL table.

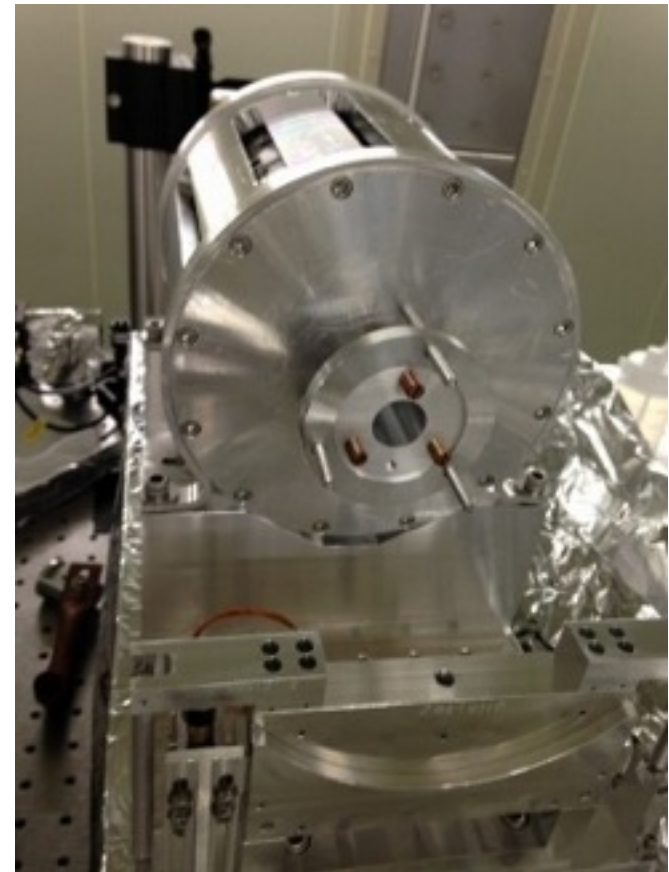

# Input Mode Cleaner

- The suspensions are assembled in NAOJ.
- We start the installing the suspensions into vacuum chambers.



# Contents

- Background
- Overview of iKAGRA input optics
- Summary of PSL test in ICRR
- IOO Installation in the KAGRA tunnel
- **Future Plan**

# Plans

- Finish the construction of the PSL table
  - Installations of EOMs, FRC, mode matching lenses and so on.
  - Initial alignment of the beam to the IMC.
  - Improvement of the PMC dynamic range
- Finish the assembling of IFI
- Finish the installation of IMC suspensions
- IMC locking.

End

# FRC In-loop noise

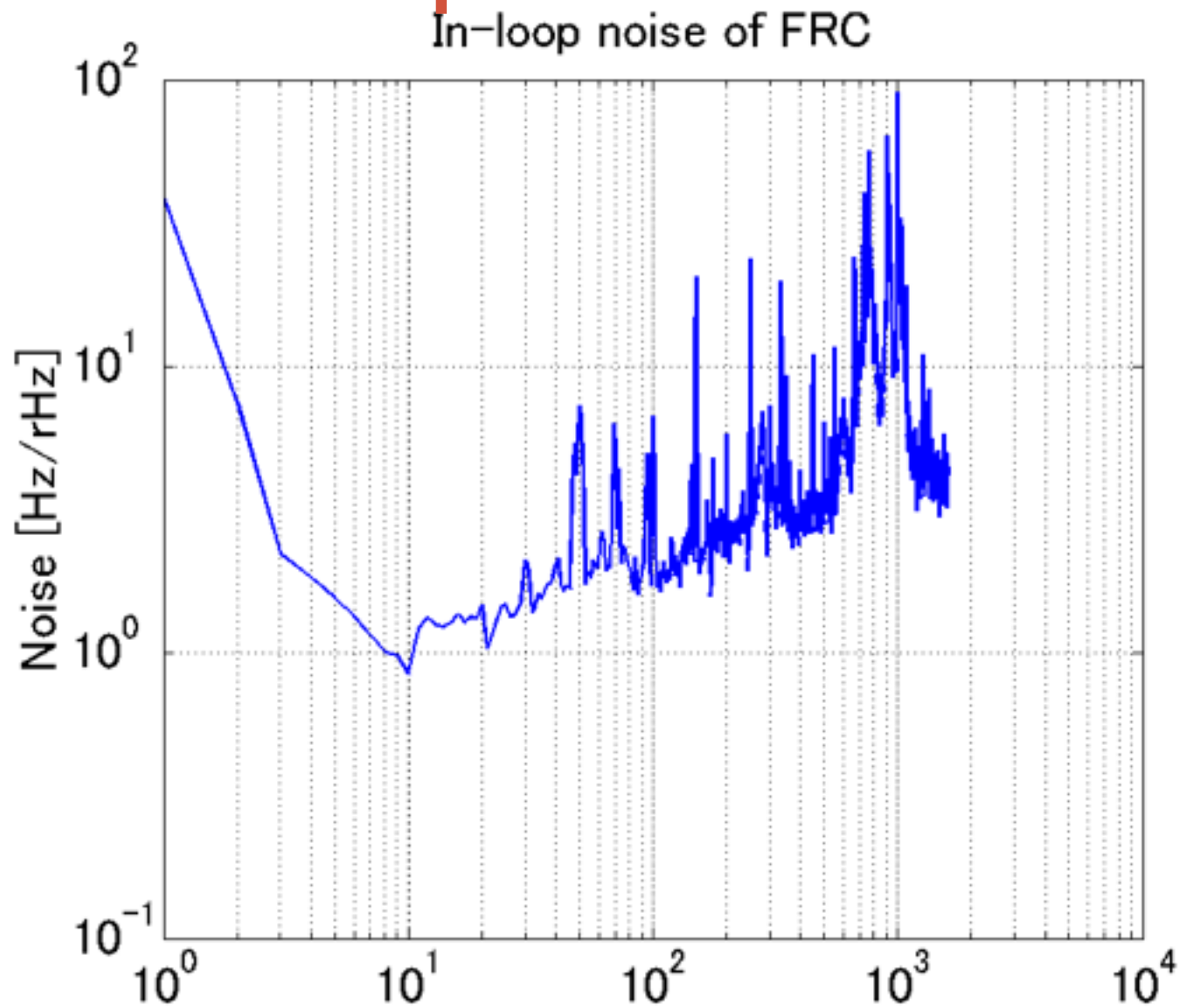



# PMC parameters

<i>Shape</i>	<i>triangular</i>
<i>Spacer</i>	<i>Invar</i>
<i>Mirror Curvature</i>	<i>300 mm</i>
<i>Round-trip length</i>	<i>40 cm</i>
<i>FSR</i>	<i>768.75 MHz</i>
<i>Finesse</i>	<i>230(p)</i>
<i>Transmissivity</i>	<i>43%(p)</i>
<i>UGF</i>	<i>~4 kHz</i>
<i>PZT resonant frequency</i>	<i>9.3 kHz</i>

# FRC fabrication: Final design for iKAGRA

## 3<sup>rd</sup> Fiber Ring Cavity



Splicing Loss : 0.01 dB,  $\alpha \cong 0.0023$

Gooch & Housego SM Coupler (99.9 % : 0.1 %)

Reducing line-width 3times

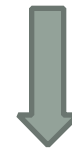

Length: 5.8 m

$f_{\text{FSR}} = 35 \text{ MHz}$

$\Delta\nu = 80 \text{ kHz}$

Finesse = 540

Contrast: 27 %

# PDH signal

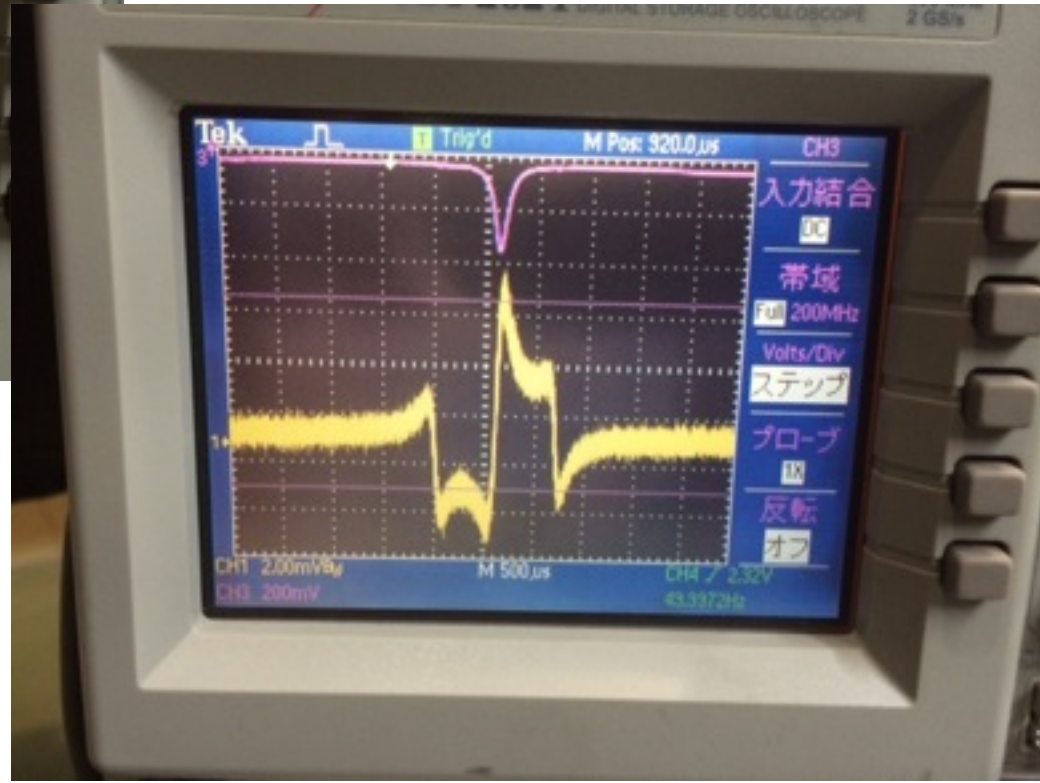
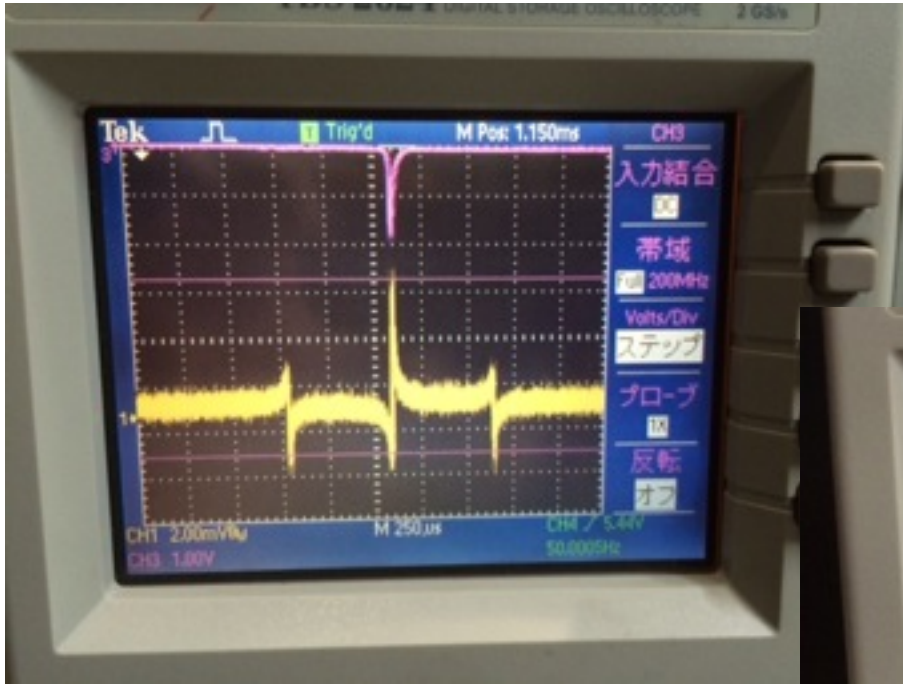

# The Particle Number

Inside

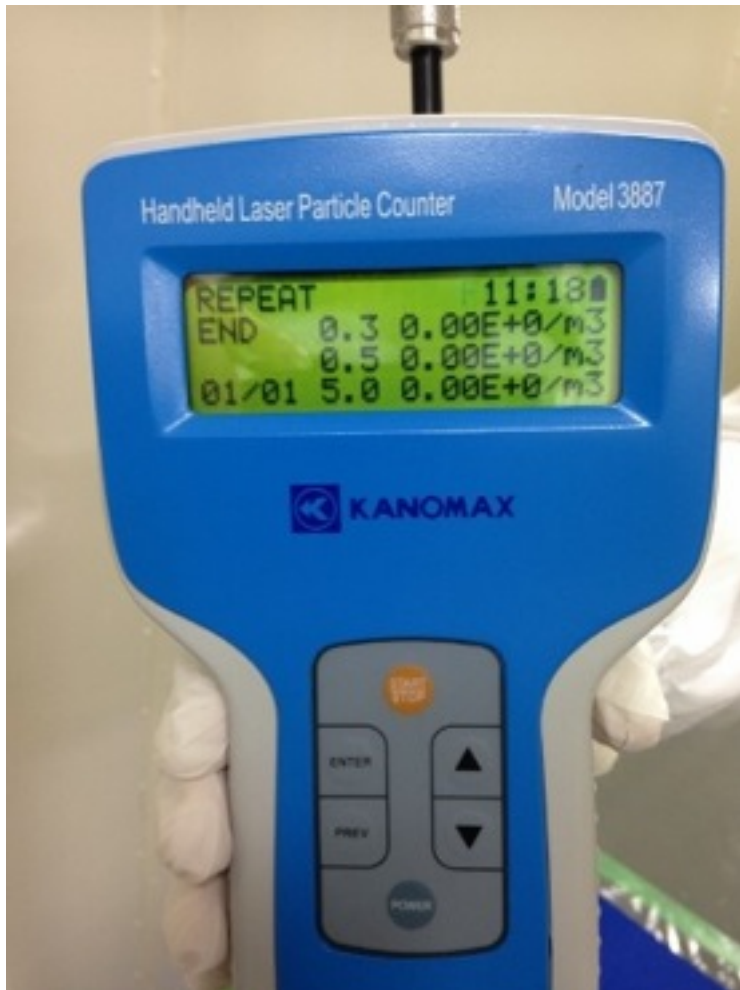

Outside

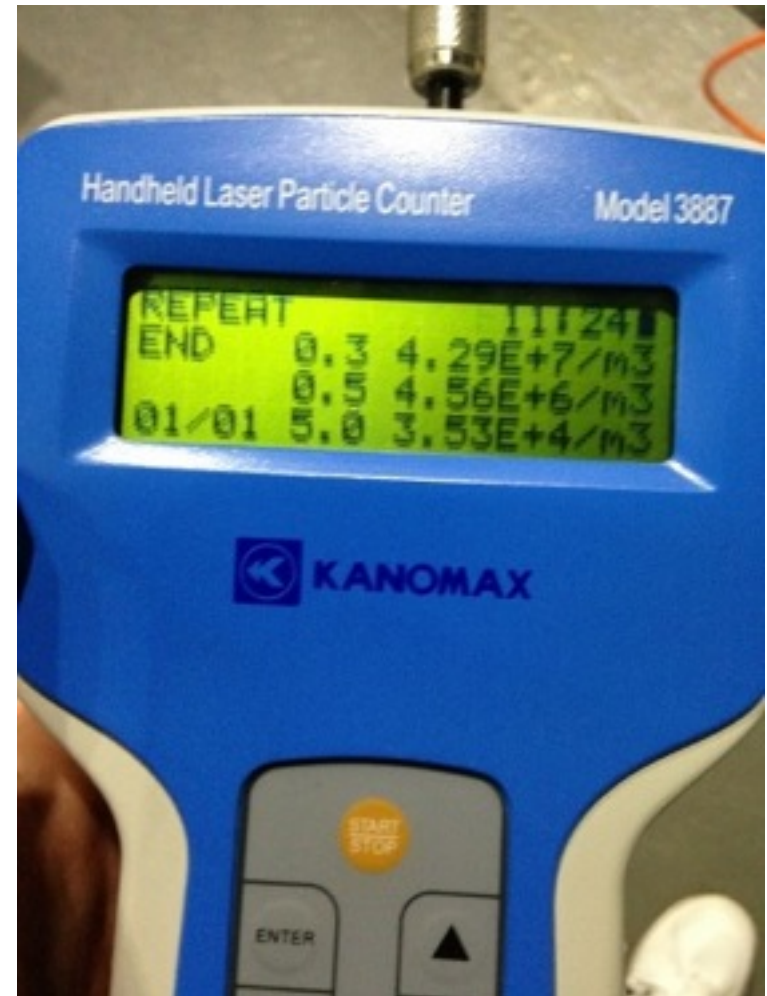

# Frequency Stabilization

- The frequency noise stabilization servo will be a multiple loop system.
- Using the Fiber Ring Cavity as a reference cavity
  - ✓ FRC is easy to use and the alignment is stable.
- This system will be tested at ICRR.

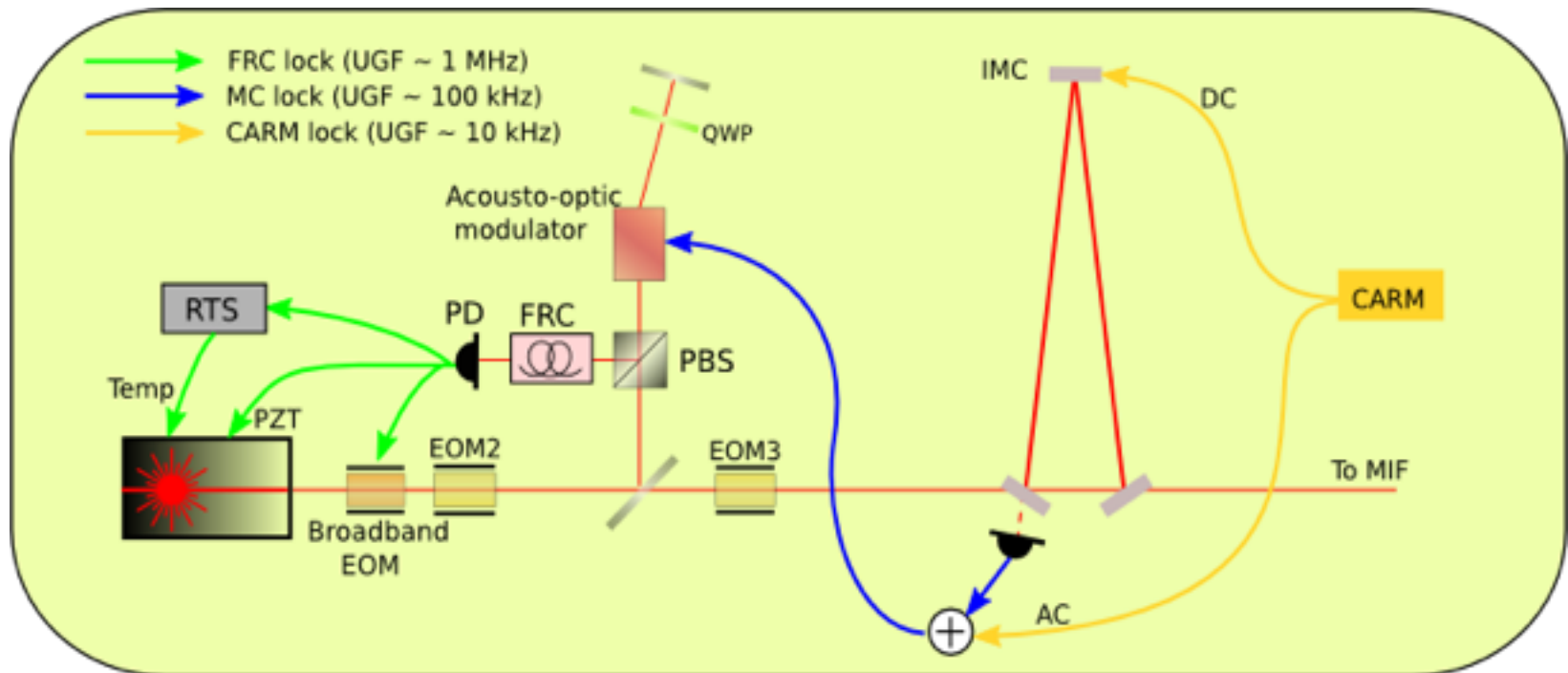

Frequency Stabilization Servo Topology