

# Control

Stepping motor

and

Displacement sensor

and

Actuators

Dan Chen

2013/12/17 Cryo-payload meeting

# Test of actuator for initial alignment in cryogenic temperature

82	1.5.1	Stepping motor (ICRR)	134日	13/11/18 (月) 14/03/31 (月)	8%	8%	Chen Dan
83	1.5.1.1	Candidate list	27日	13/12/05 (木) 13/12/31 (火)	50%	50%	Sekiguchi Takanori, Takahashi R., Chen Dan
84	1.5.1.2	Procurement of candidates	78日	13/11/29 (金) 14/02/14 (金)	0%	0%	Takahashi R., Yamamoto Kazuhiro
85	1.5.1.3	Preparation for candidates test	26日	13/11/18 (月) 13/12/13 (金)	0%	0%	Chen Dan, Student from AEI Hannover
86	1.5.1.4	Test at cryo temp	1.43月	14/02/17 (月) 14/03/31 (月)	84,85	0%	To be determined (ICRR), Small cryostat

## Candidate and Status

Name	Number we have in ICRR	comment
Stepping motor	0	The delivery time is 2.5 month. The company said this works at 4K. <b>We have ordered.</b>
Pico motor	1	We had a cooling test using a PT cooler. <b>But it did not work below 200K.</b>
Autex	0	Salesmen from Autex show us a motor (PZT). But they said they don't have experience at 10K. They will give us a sample for cooling test. And they will search a stage for cryo.

# Calculation of the requirement for the mass shifter

Dynamic range we need:

**1mrad** ← Beginning adjustment limit by hand

Accuracy we need:

**3urad** ← 1 step of the mass shifter = 1 cm shift of main beam on the other TM

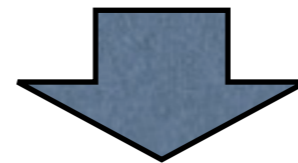
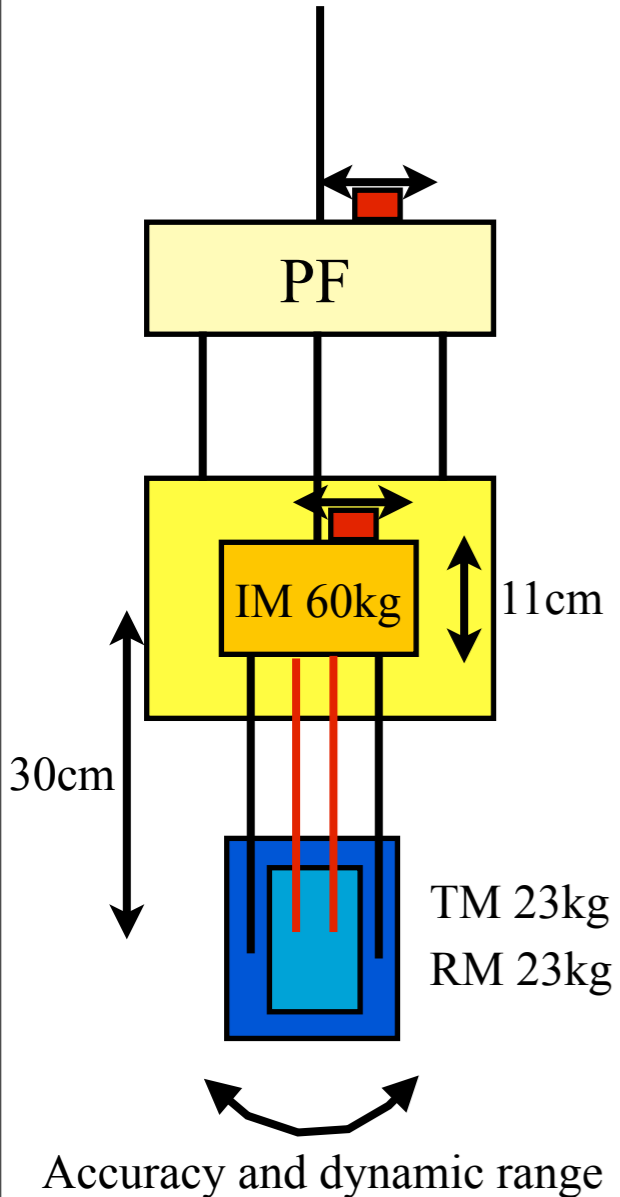

For IM calculation by Dan and Ono

Mass: 0.5kg

Drive range:  $\pm 4\text{cm}$  →  **$\pm 1\text{mrad}$**       Drive accuracy:  $120\mu\text{m}$  →  **$3\text{urad}$**

Mass: 1.0kg

Drive range:  $\pm 2\text{cm}$  →  **$\pm 1\text{mrad}$**       Drive accuracy:  $60\mu\text{m}$  →  **$3\text{urad}$**

Mass: 2.0kg

Drive range:  $\pm 1\text{cm}$  →  **$\pm 1\text{mrad}$**       Drive accuracy:  $30\mu\text{m}$  →  **$3\text{urad}$**

Virgo: start=1-1.5mrad, step=3urad, range=10mrad= $\pm 1.5\text{cm}$ , mass=0.27kg

→ 1 step <  $120\mu\text{m}$ ,  $60\mu\text{m}$ ,  $30\mu\text{m}$

**M=0.5kg, 1kg, 2kg**

←—————→  
8cm, 4cm, 2cm

- \*We assumed the cryo-payload is rigid. So the real dynamic range should be smaller.
- \*The drive accuracy of the mass shifter we will make can be smaller. So the accuracy angle can be finer.
- \*Do we need more dynamic range? We can not use water level?

# Test of actuator for initial alignment in cryogenic temperature A/I

- We will make a test stage for Stepping motor.
  - ▶ We have to consider the connection point between the motor we ordered and this stage.
- We have to consider the rotate component.
  - ▶ We have to calculate the requirement.

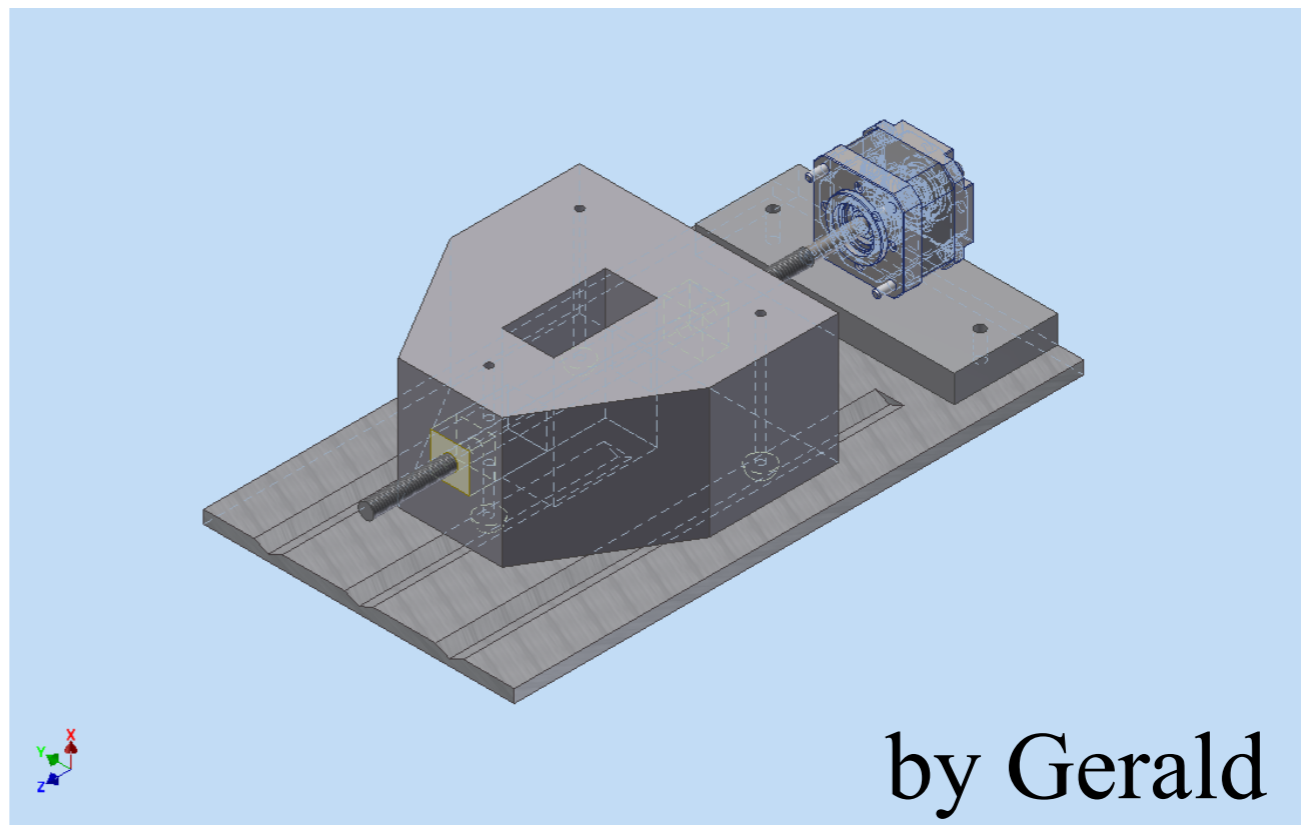
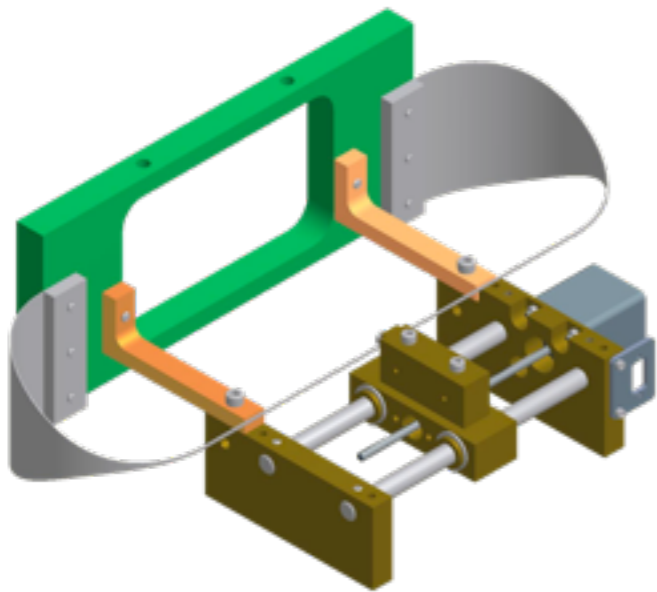

by Gerald

We drew a roughish figure.

# Test of Displacement sensor and actuators (OSEM) in cryogenic temperature

87	1.5.2	Displacement sensor and actuators (between Intermediate Mass and Intermediate Recoil Mass) (ICRR)	117日	13/11/04 (月) 14/02/28 (金)		0%	0%	Chen Dan
88	1.5.2.1	Candidate list of light sources and photo diodes	12日	13/11/04 (月) 13/11/15 (金)		0%	0%	Suzuki T, Takahashi R, Yamamoto Kazuhiro, Chen Dan
89	1.5.2.2	Procurement of candidates of light sources and photo diode	26日	13/11/16 (土) 13/12/11 (水)	88	0%	0%	Chen Dan
90	1.5.2.3	Preparation of test for the candidates of light sources and photo diode	12日	13/11/29 (金) 13/12/10 (火)		0%	0%	Chen Dan, Student from AEI Hannover
91	1.5.2.4	Test for the candidates of light sources and photo diode	20日	13/12/12 (木) 13/12/31 (火)	90,89	0%	0%	Chen Dan, Small cryostat
92	1.5.2.5	Preparation for test of sensor	27日	13/11/17 (日) 13/12/13 (金)		0%	0%	Student from AEI Hannover
93	1.5.2.6	Test of sensor at cryogenic temperature	54日	14/01/06 (月) 14/02/28 (金)	92	0%	0%	To be determined (ICRR), Small cryostat

## Status

PD: We tested 2 PDs at low temperature.

LED: One of LD works at 77K.

# PD

Name	Type	Peak	Number we have in ICRR	comment
S1223-01	Si PIN PD	960 nm	5	We had a cooling test. Efficiency decreases at low T (37%)
G8370-01	InGaAs PIN PD	1550 nm	0	Tomaru-san said this works at low T. I asked a quotation but it was out of stock.
FGA21	InGaAs Pin PD	1600 nm	2	The quantum efficiency decreases at low T(15%).
FDG03	Ge PD	1550nm	0	We ordered. ThourLab said it works at low T.
S3590	Si PIN PD	980nm	0	We can order. But LED doesn't work. So we don't need?

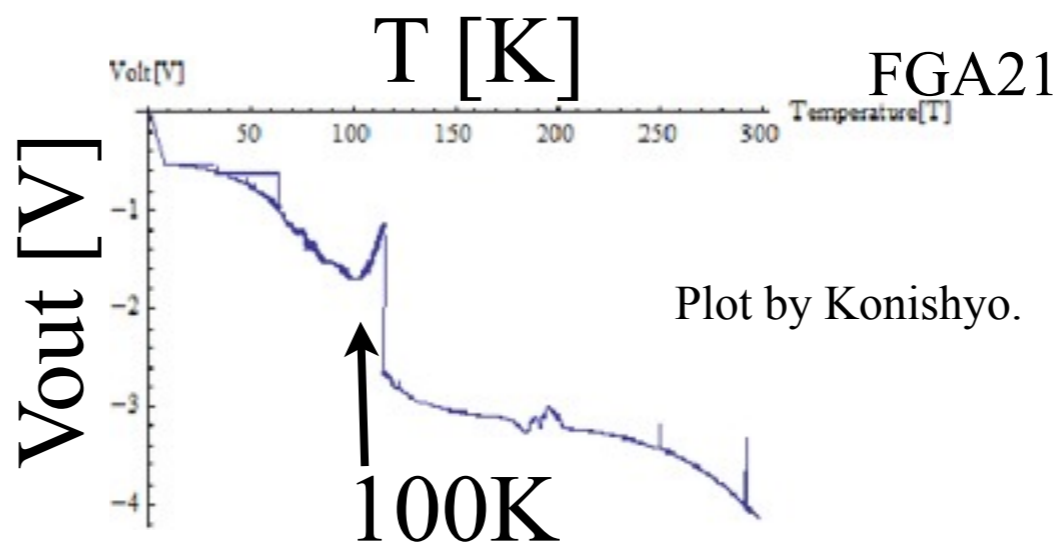
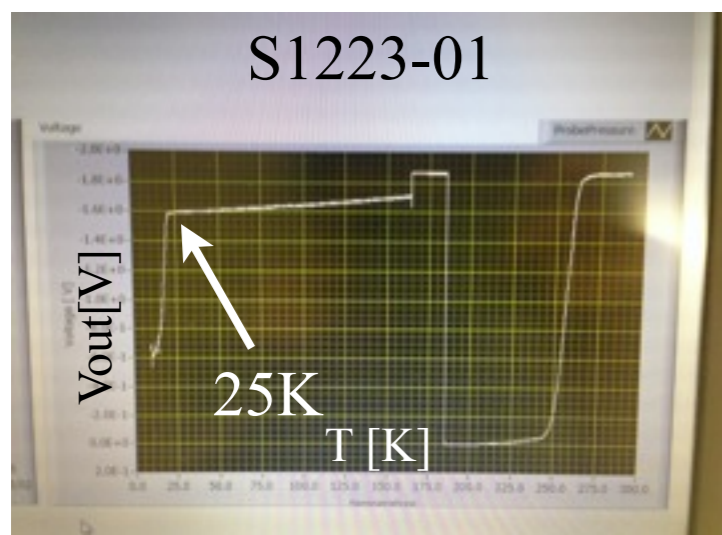

# LED

Name	Type	Peak	Number we have in ICRR	comment
OP232	GaAlAs	890 nm	5	This is used in OSEM at room temperature.
L2656-03	GaAlAs	890 nm	20	Tomaru-san said this works at low T. I received.
ML925B45F	InGaAsP	1550 nm	2	

Liquid nitrogen test: 77K

OP232	Does not work
ML925B45F	Works!

Detect by sensor card

# Test of Displacement sensor and actuators (OSEM) in cryogenic temperature A/I

- Search other PD and LED. (Manu is in process.)
- Test LEDs we have in 77K and cryostat.
- Calculate the noise from the data we have now.
- Actuator?

必要な周波数帯は0.5-100Hz?

Dark noise of FGA21

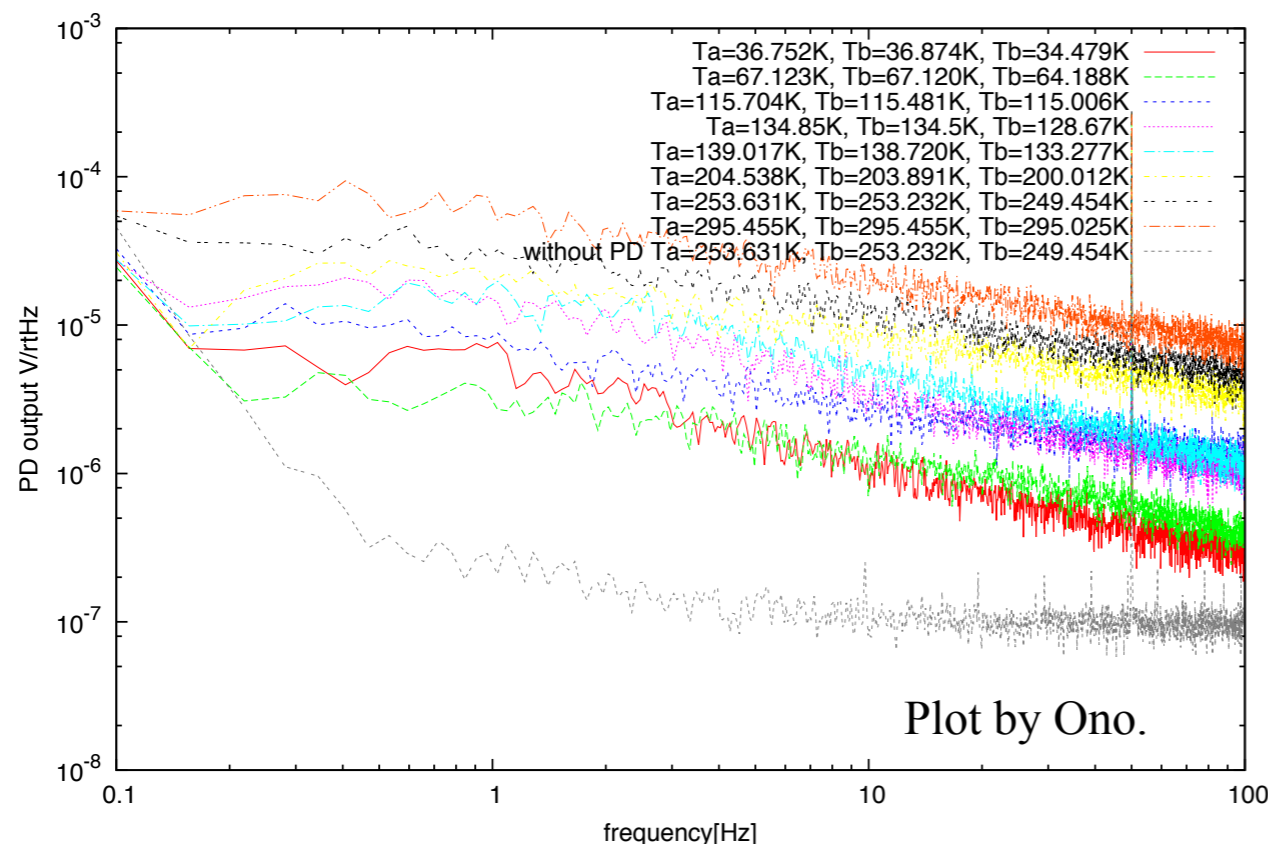

Dark noise of S1223

