

Report on detector characterization

Kazuhiro Hayama
detector characterization team

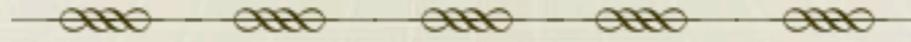

- **Commissioning stage**

With each subsystem,

- **Tools for subsystem diagnostics**

- **Support to kill noise sources**

- **Calibration (with MIF, DGS, DMG etc)**

- **Observation stage**

- **Veto analysis (rejection of glitches)**

- **Noise modeling to improve false alarm rate**

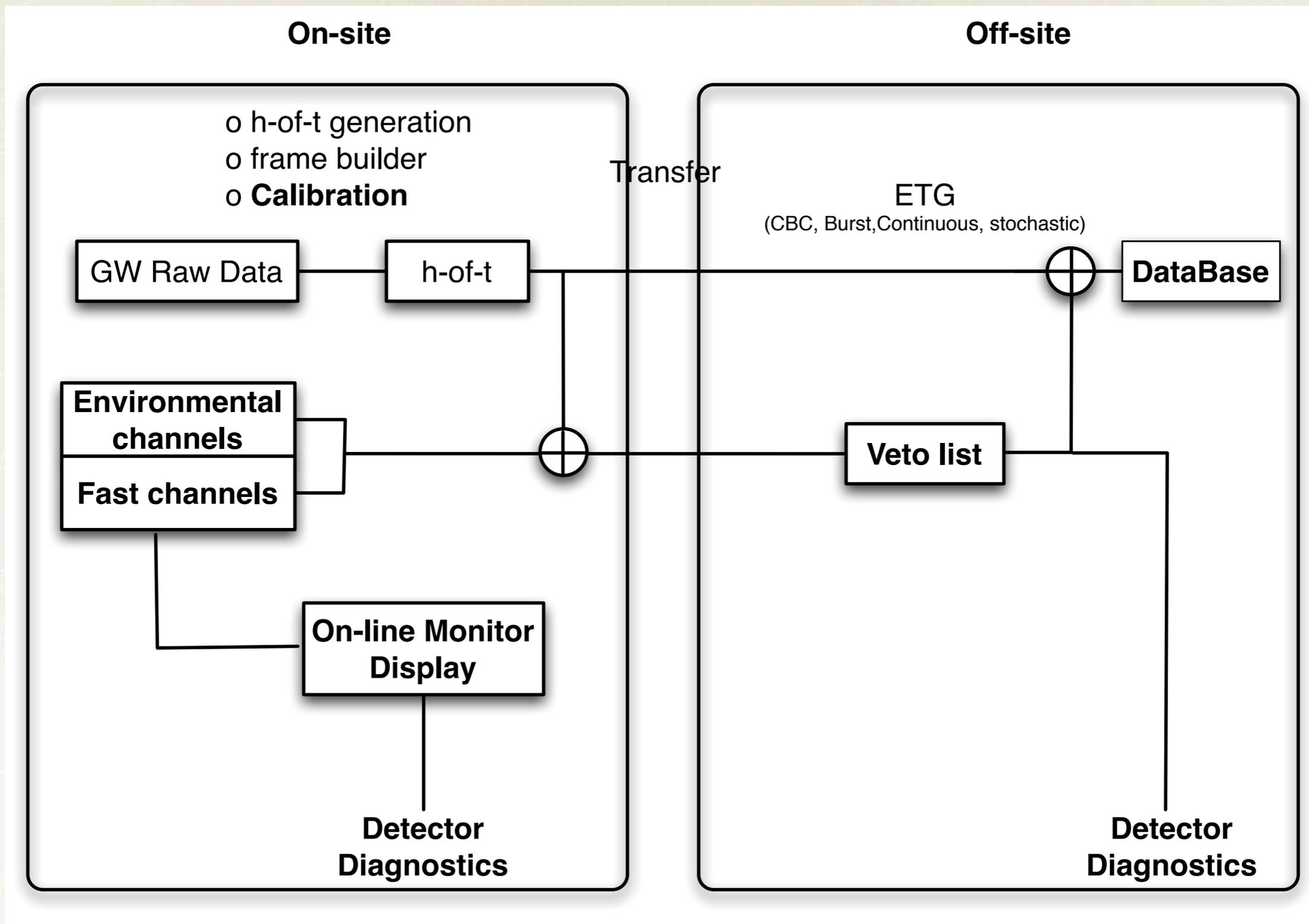
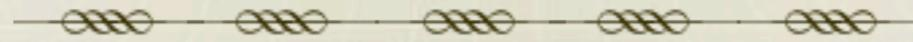

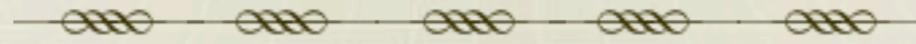

On-site

Off-site

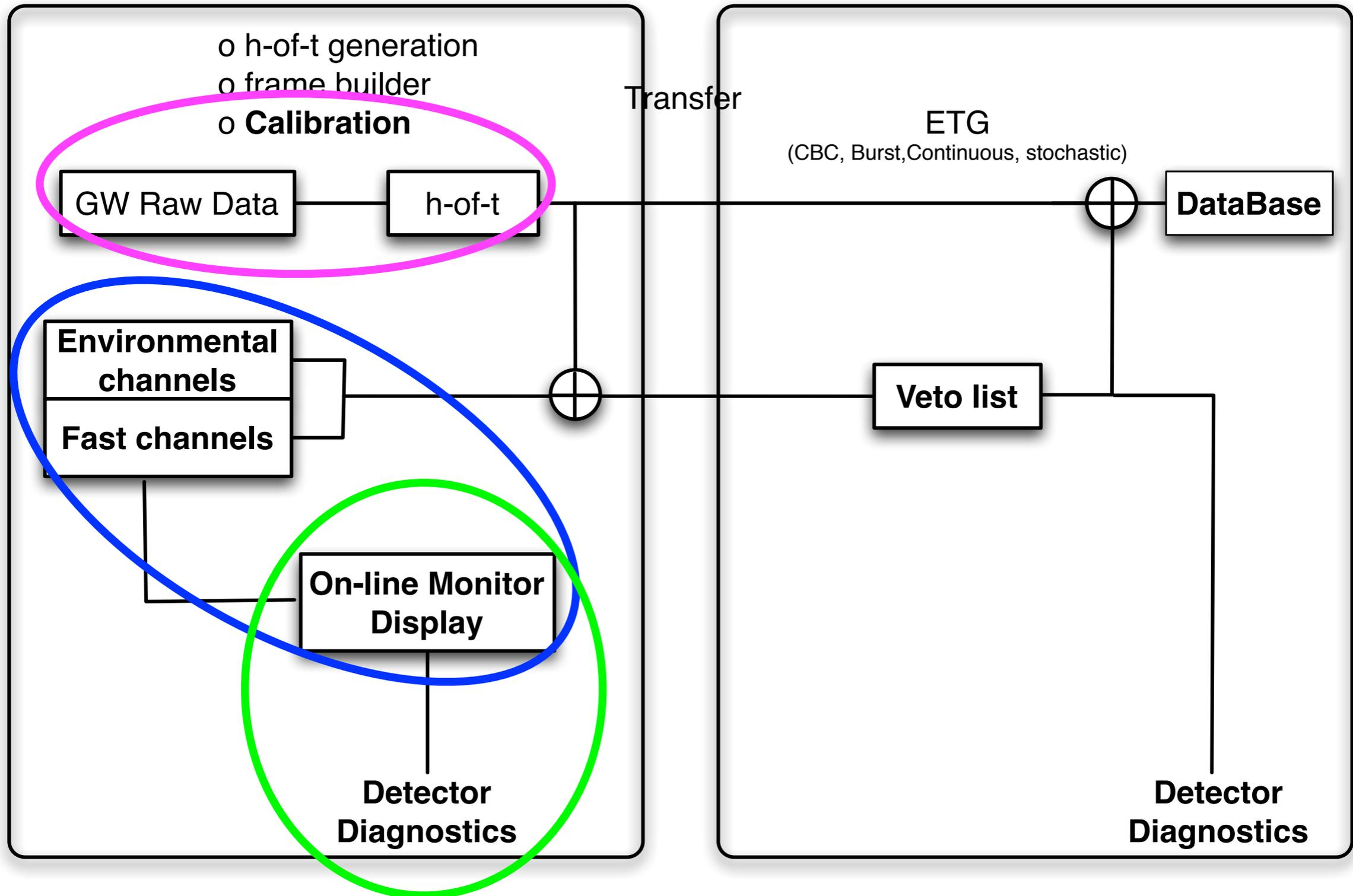

Detector Characterization

Inst. Mon



Laser Intensity

16s

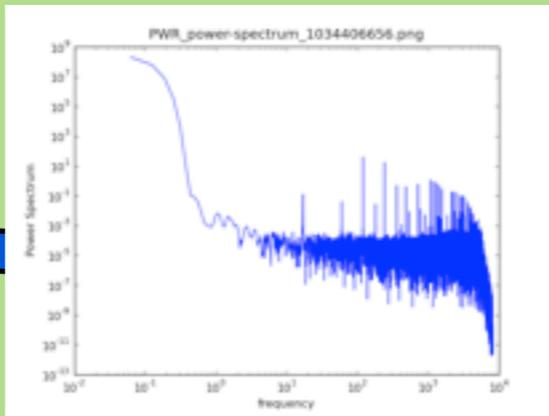
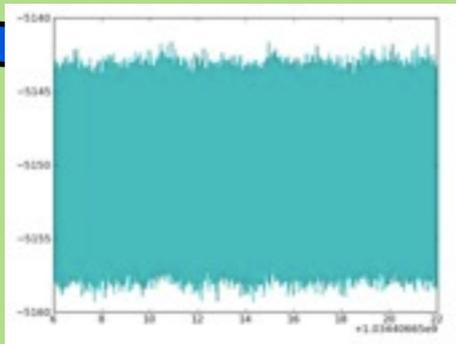

RT WS



RealTime update @16s

Env. Mon



acce.

100file

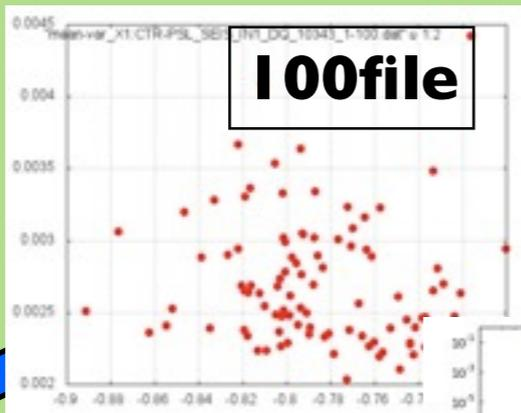

16s

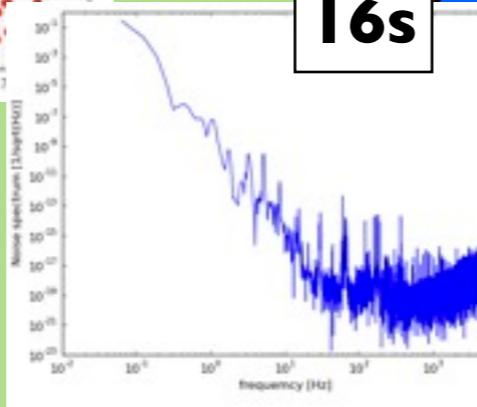

Sens. Mon



CLIO

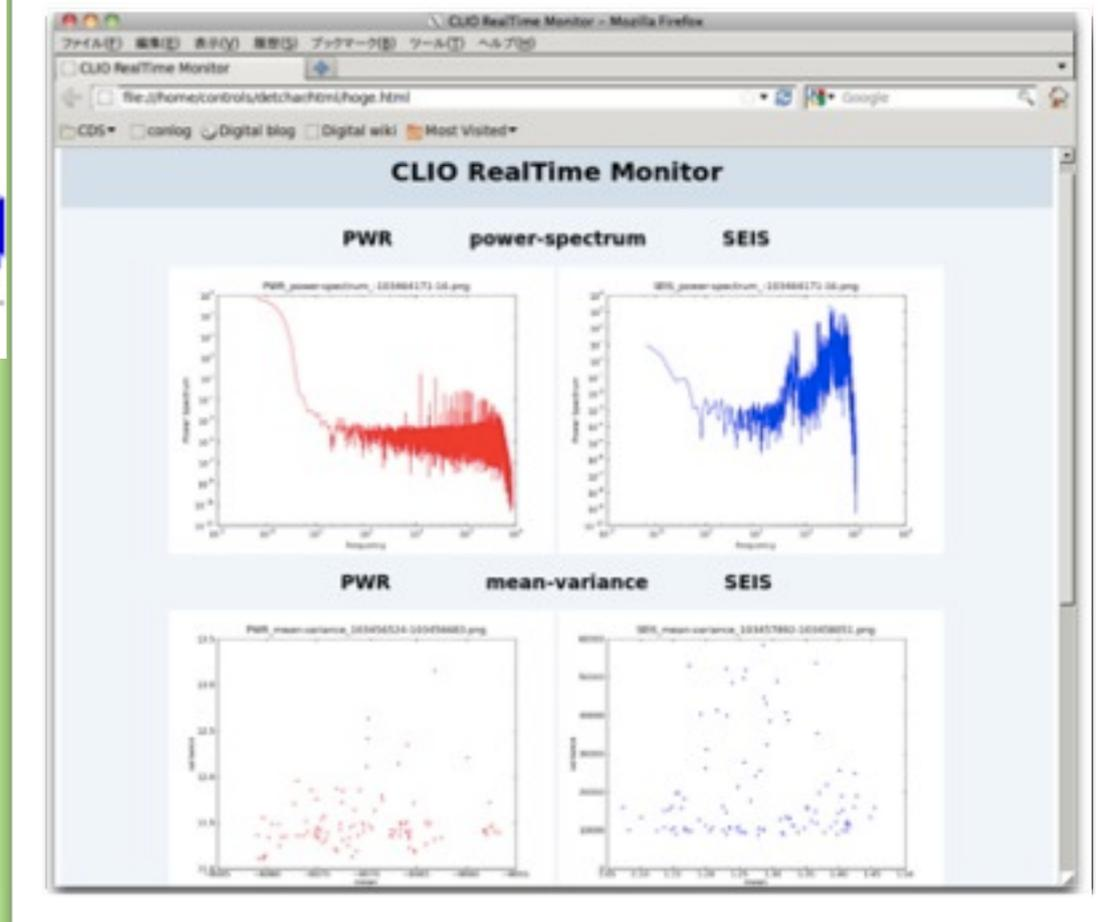

K.Tanaka

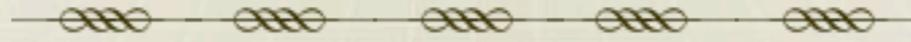

Calibration

Convert to physical unit

Processing on time-series data

Generation of filters of TF

→ various kinds of analysis

Inspirational Range

Test Operation
~10 kpc

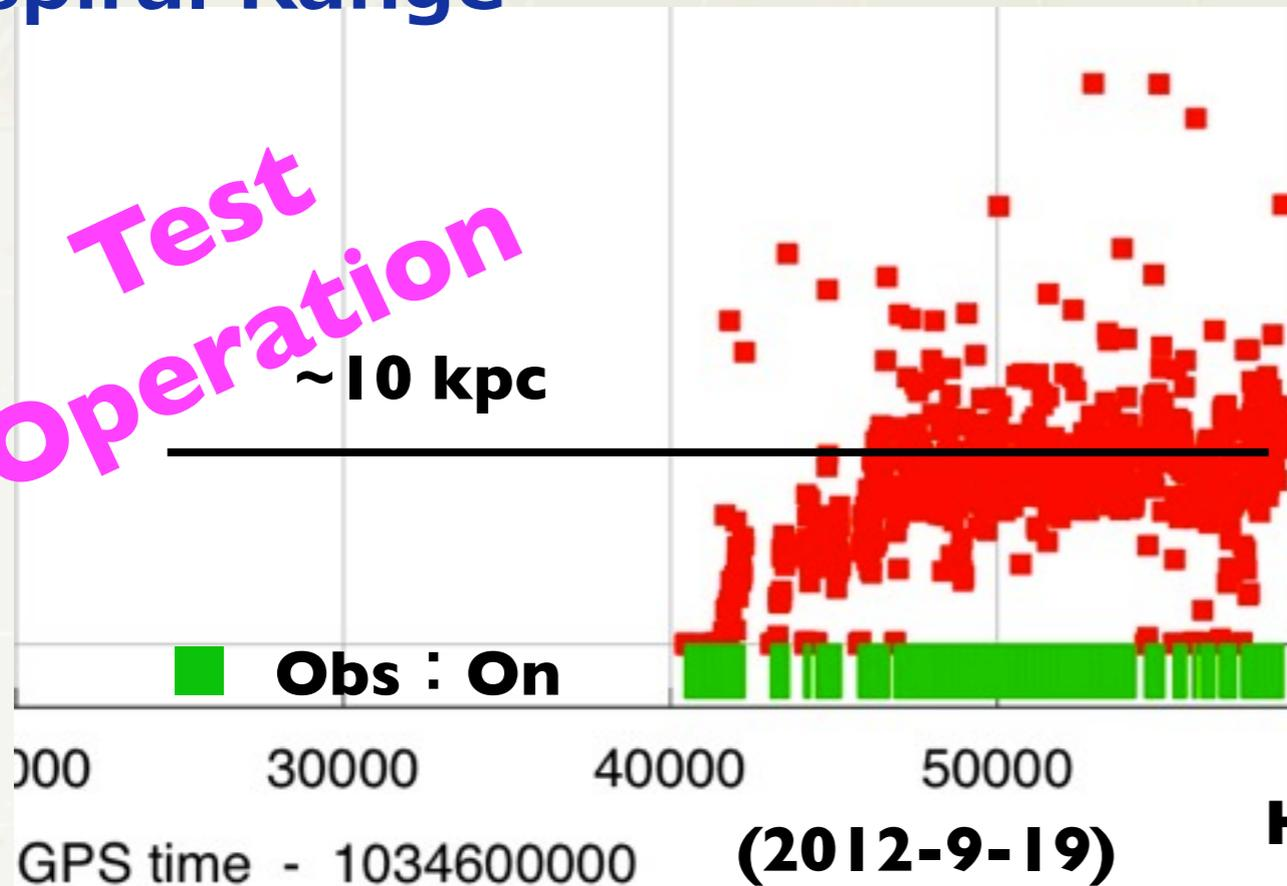

- Real time display of the inspiral range
- Total locked time ~13hrs

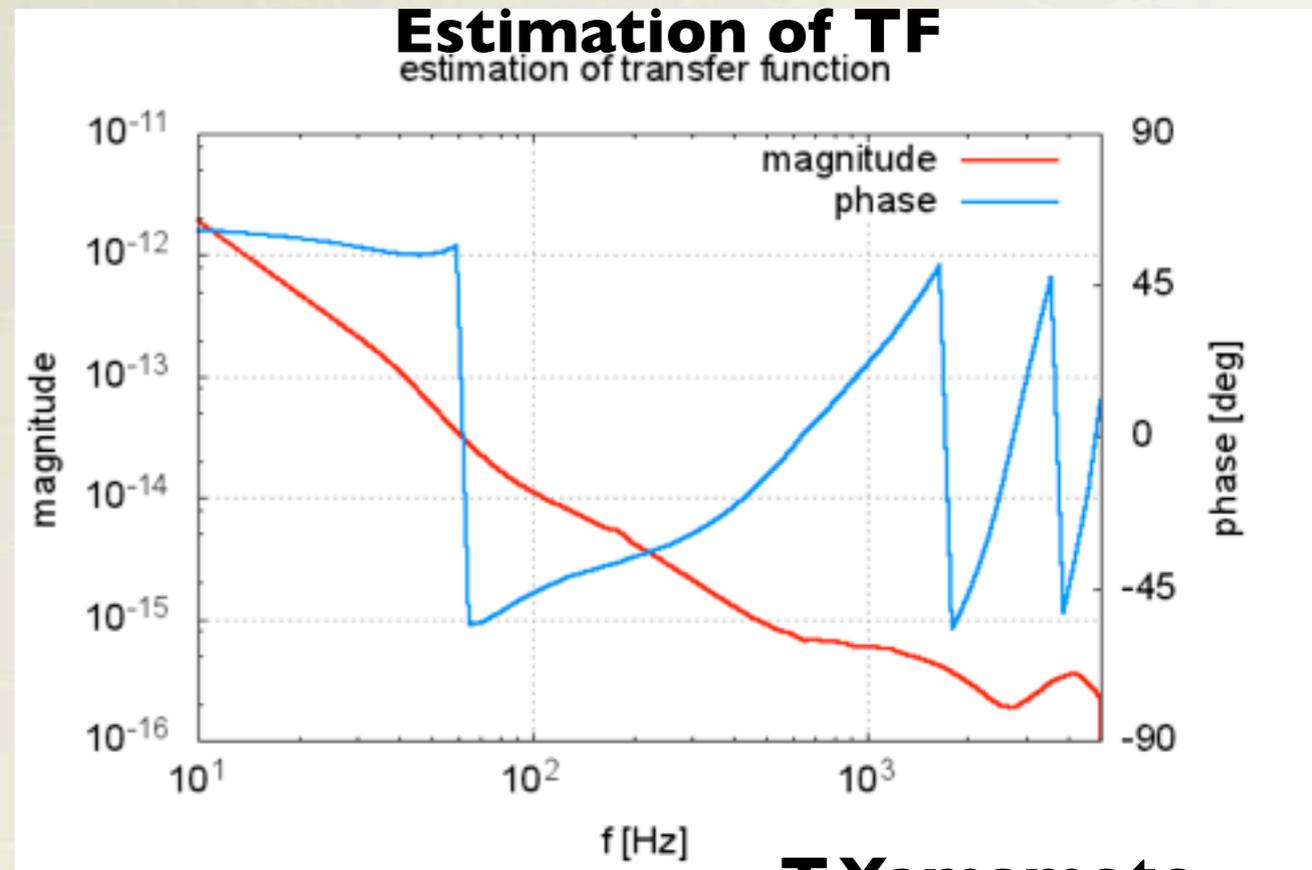

T.Yamamoto

H.Yuzurihara

- System installed in NAOJ
- System installed in CLIO
- Test running during CLIO test operation.

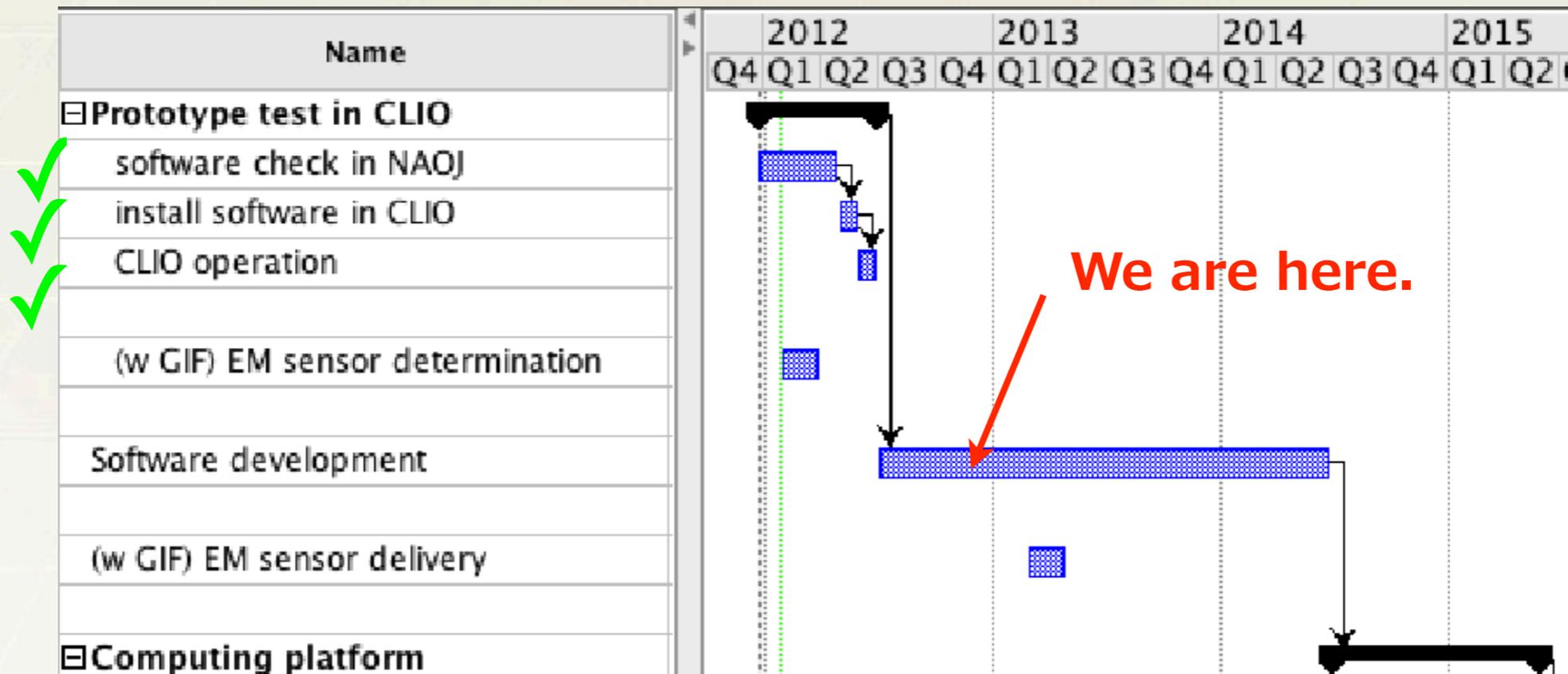

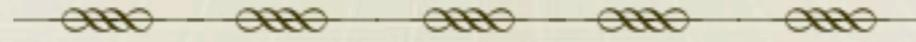

For commissioning

- **subsystem diagnostics**
 - **Method for localization of noise sources**
 - **Evaluation of data quality**
 - **Sophistication of on-line monitor display**
 - **Calibration**

For Observation

- **Veto analysis**
 - **Method for distinguish triggered events are GW or not**
- **Data quality flag**
- **Distribution of data quality information to both internal and external collaborators**

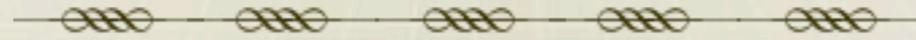

We discussed with K-detchar on our collab. projects and set our goal in last Dec. and this Feb.

Goal:

Development of a method for

localizing noise sources using auxiliary channels and PEMs.

Support to kill noise sources

- So far several groups in LSC(including KGWG) have made their efforts on a **post-processing analysis (mainly Veto)** to distinguish whether triggered events are glitches or not.
- Our project focuses on **a tool useful for commissioning.**

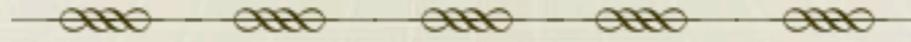

- **Event detection pipelines (K)**
- **Future selection statistics (t- or z- statistics) (K)**
- **To measure channels' responsibility for noise events**
- **Classification of noise events (J)**
- **Integrating these information, localize the noise sources.**

Develop the pipeline using CLIO data, and LIGO, Virgo data.

o First Exam is to localize hardware injection we generated last CLIO operation.

o

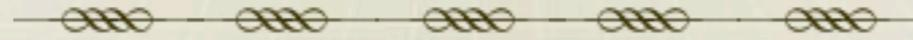

- There are several discussions
 - The Shadow monitor to reduce effects of violin modes.
→ Particularly, burst searches should be improved.
Evaluate what impact the monitor gives on data analysis?
 - Correlated environmental noise in global detector network.
→ Stochastic GWB search should be affected.
 - Calibration accuracy