

# **Report on detector characterization**

**Kazuhiro Hayama**  
**detector characterization team**

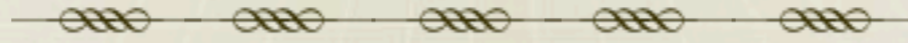

- **Commissioning stage**

**With each subsystem,**

- **Tools for subsystem diagnostics**

- **Support to kill noise sources**

- **Calibration (with MIF, DGS, DMG etc)**

- **Observation stage**

- **Veto analysis (rejection of glitches)**

- **Noise modeling to improve false alarm rate**

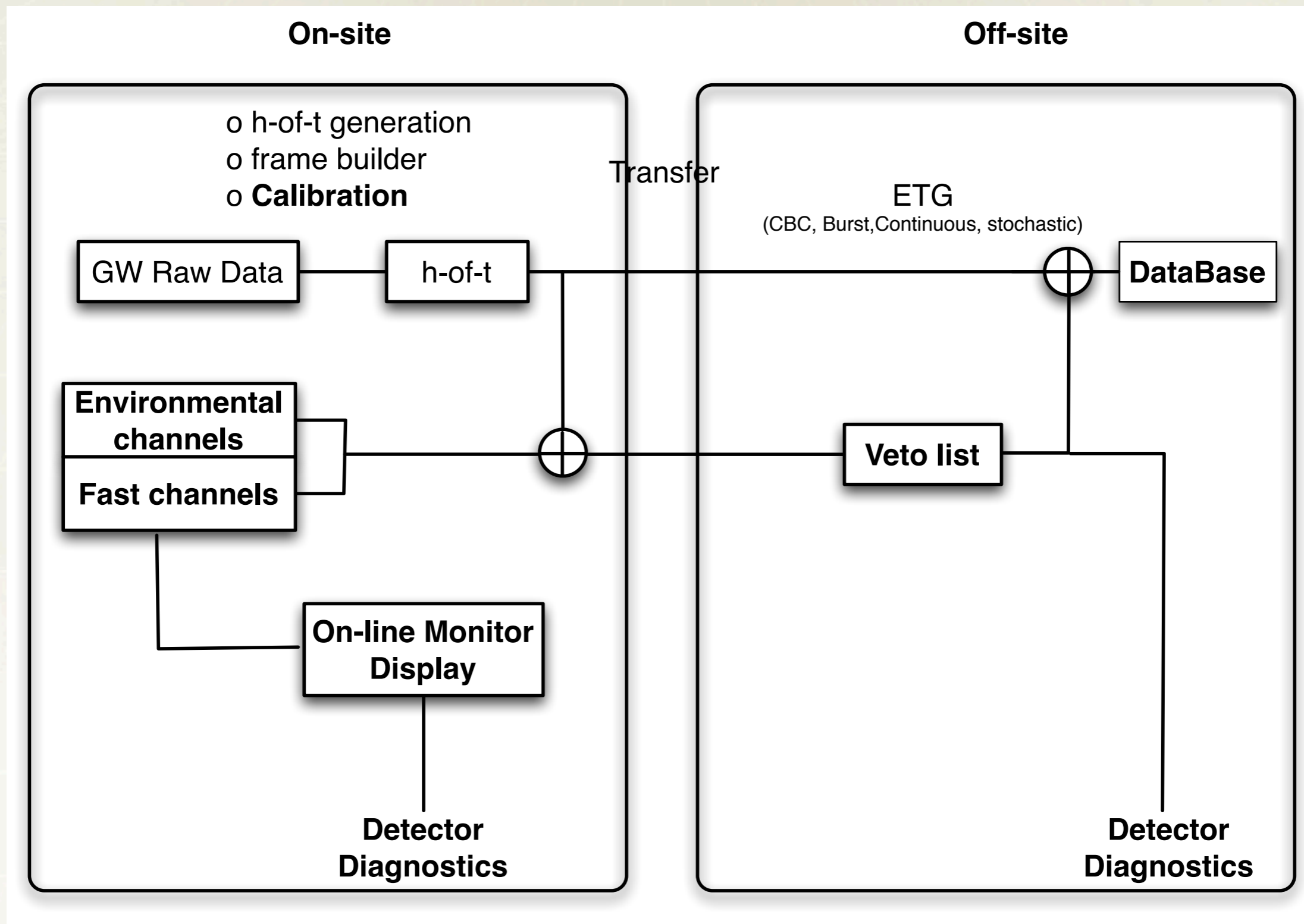
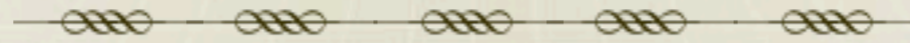

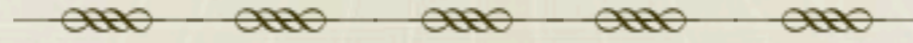

## On-site

## Off-site

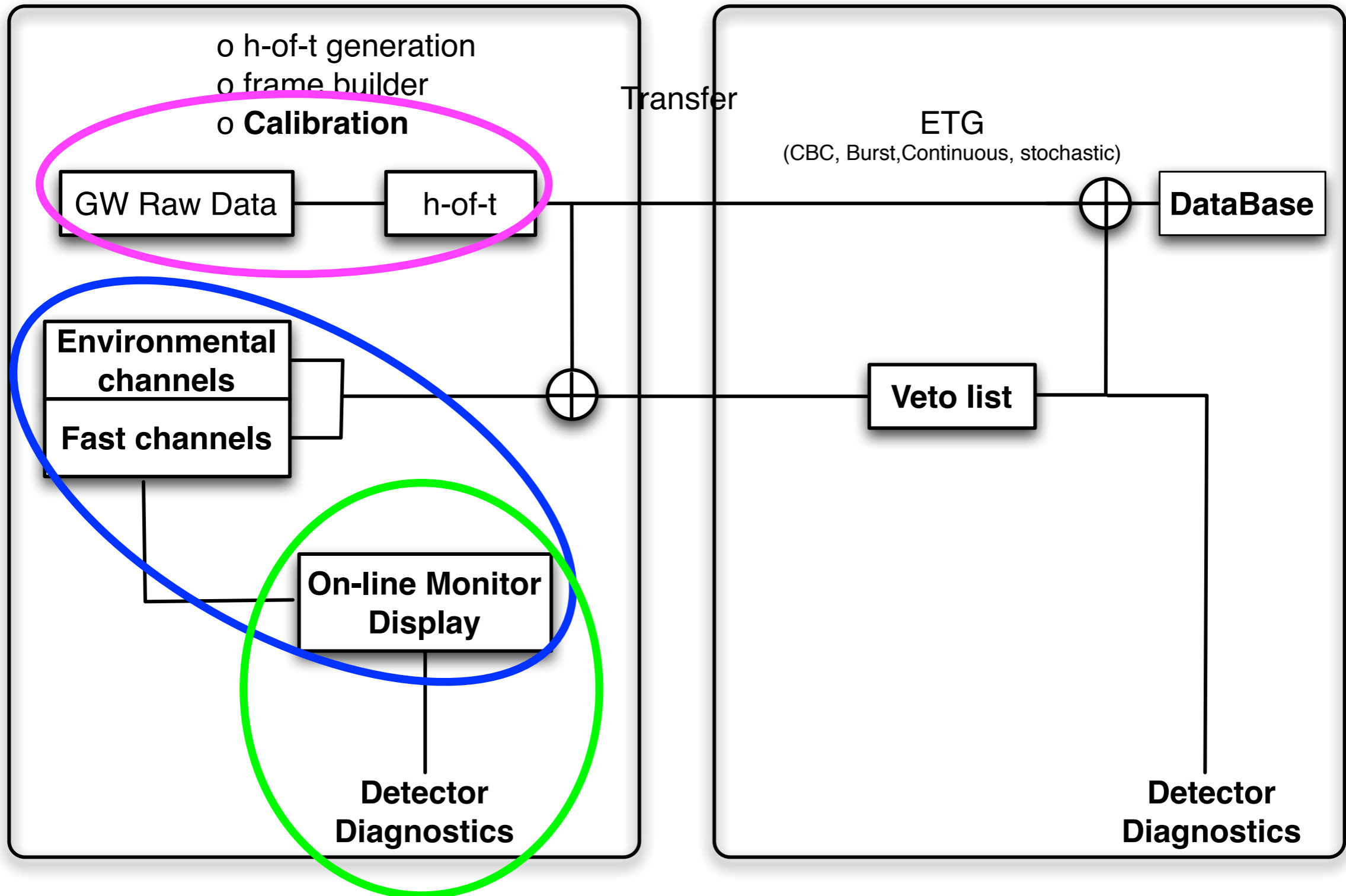

# Detector Characterization

**Inst. Mon**



Laser Intensity

16s

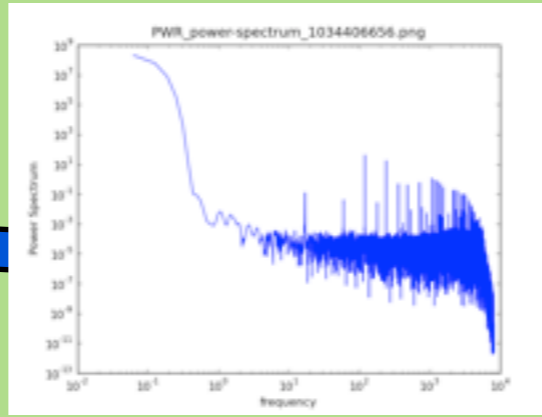
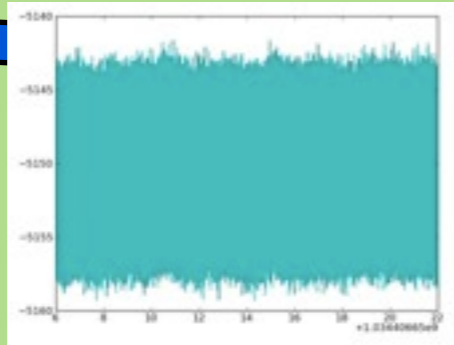

RT WS



RealTime update @16s

**Env. Mon**



acce.

100file

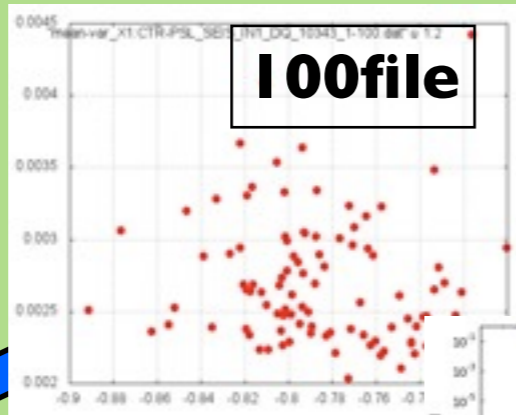

16s

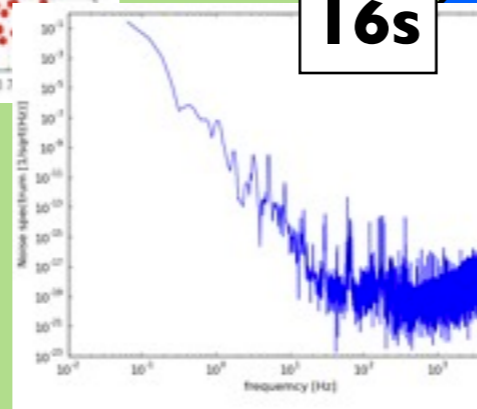

**Sens. Mon**



CLIO

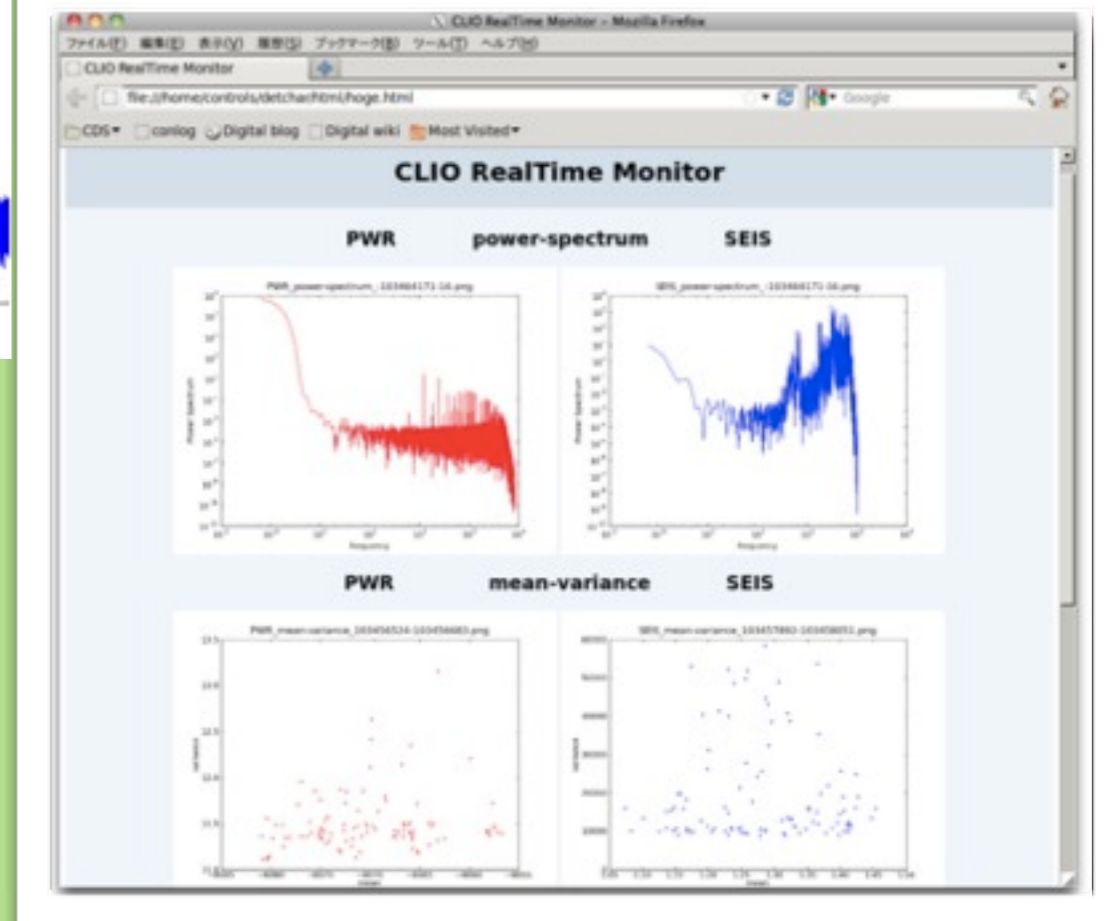

K.Tanaka

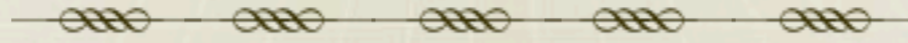

# Calibration

Convert to physical unit

Processing on time-series data

Generation of filters of TF

→ various kinds of analysis

# Inspirational Range

**Test Operation**  
~10 kpc

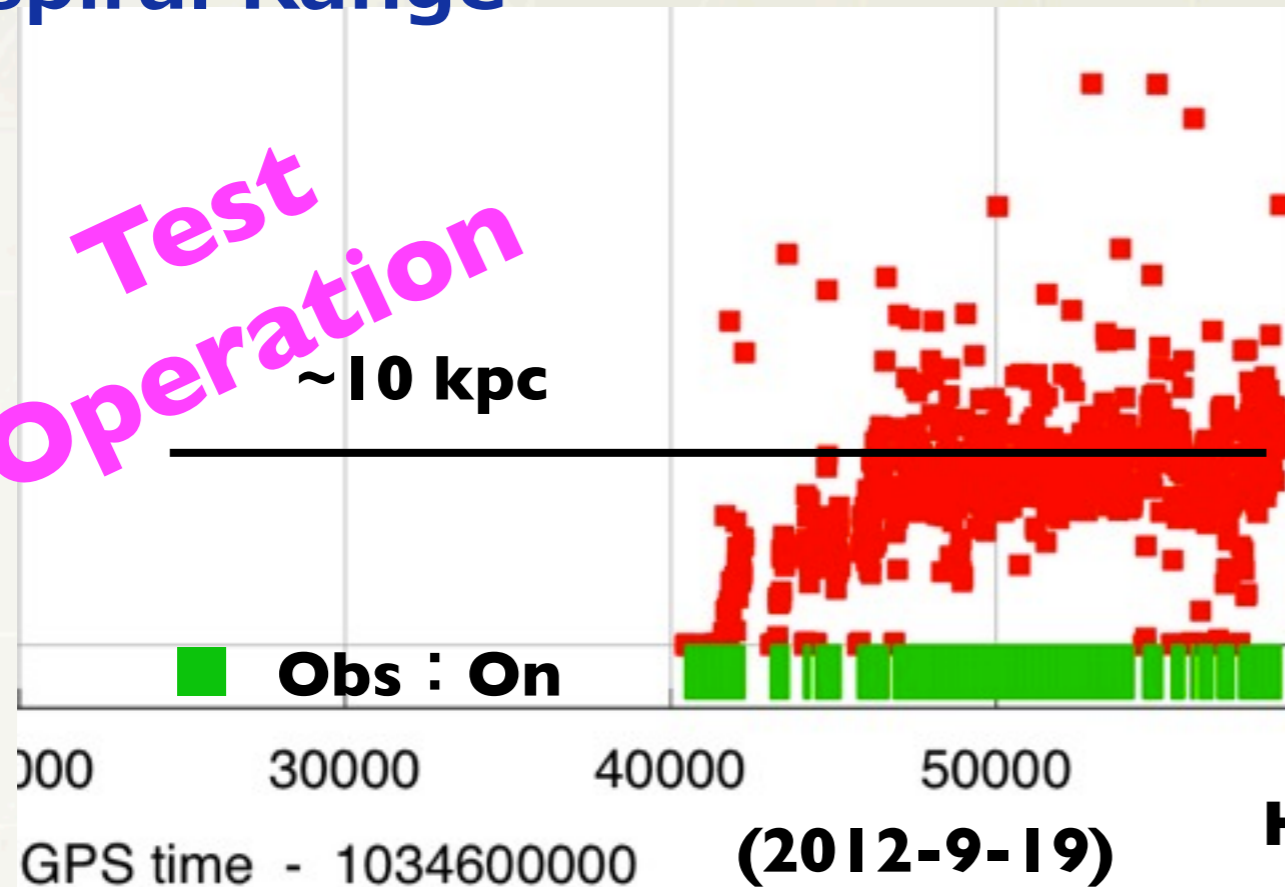

- Real time display of the inspiral range
- Total locked time ~13hrs

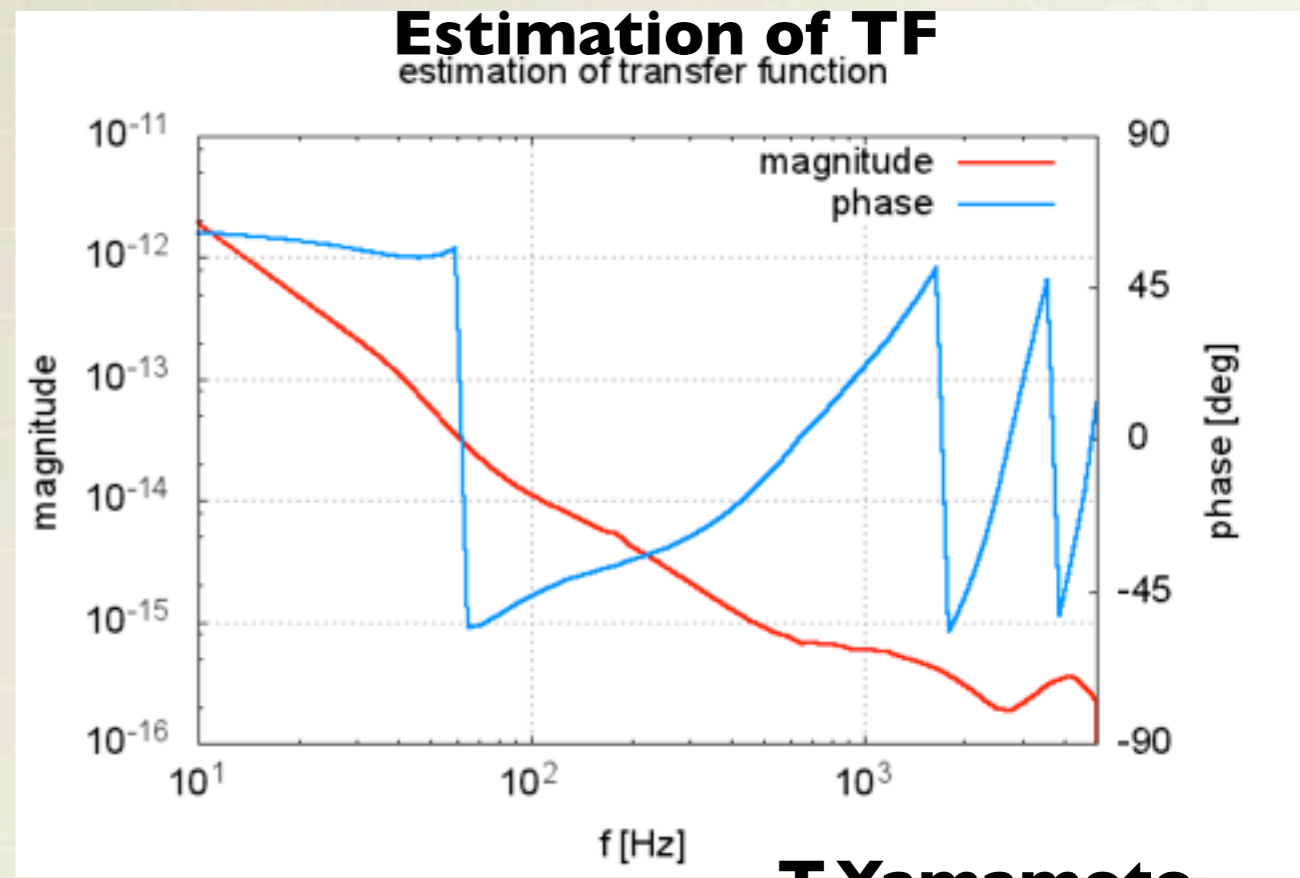

**T.Yamamoto**

**H.Yuzurihara**

- System installed in NAOJ
- System installed in CLIO
- Test running during CLIO test operation.

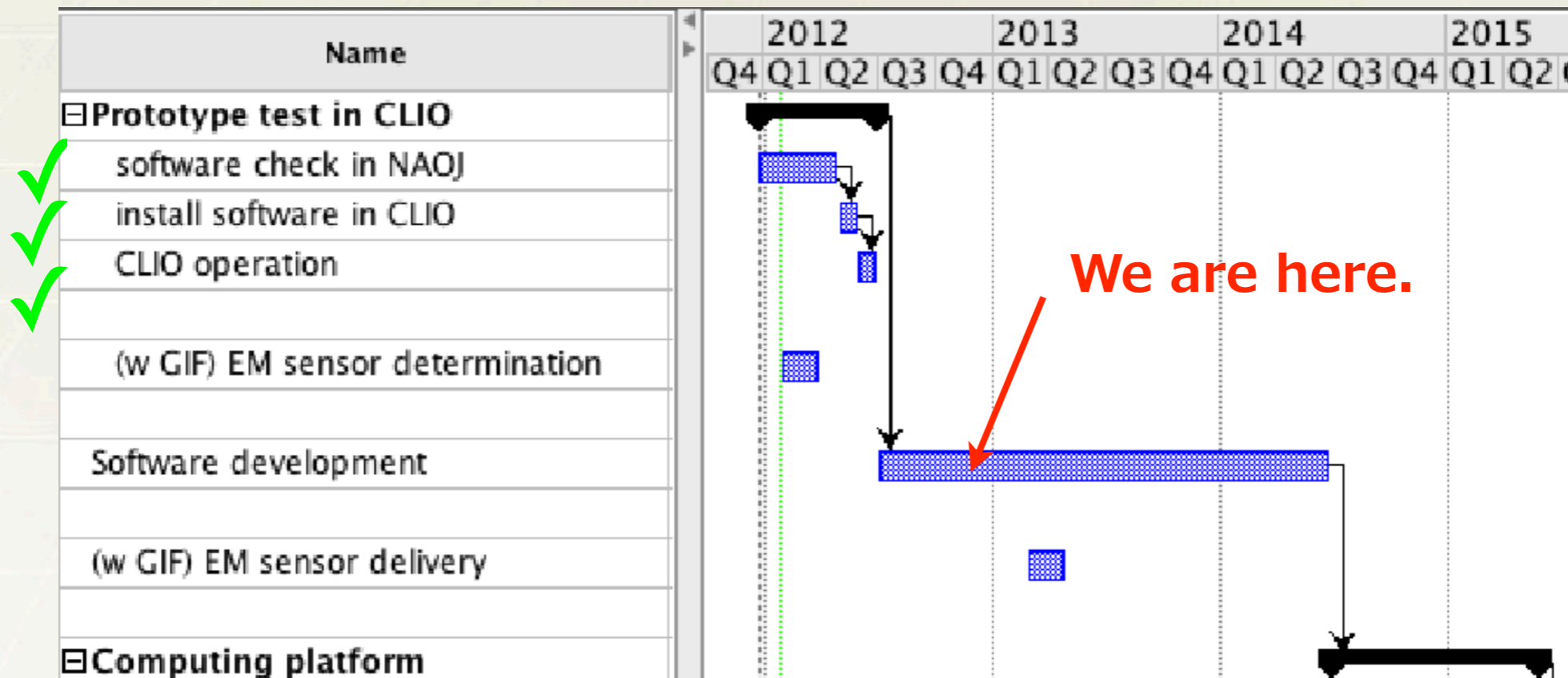

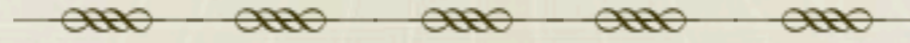

## For commissioning

- **subsystem diagnostics**
  - **Method for localization of noise sources**
  - **Evaluation of data quality**
  - **Sophistication of on-line monitor display**
  - **Calibration**

## For Observation

- **Veto analysis**
  - **Method for distinguish triggered events are GW or not**
- **Data quality flag**
- **Distribution of data quality information to both internal and external collaborators**



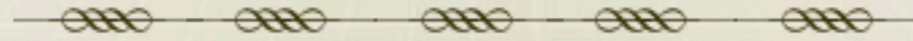

We discussed with K-detchar on our collab. projects and set our goal in last Dec. and this Feb.

## Goal:

Development of a method for

**localizing noise sources** using auxiliary channels and PEMs.

Support to kill noise sources

- So far several groups in LSC(including KGWG) have made their efforts on a **post-processing analysis (mainly Veto)** to distinguish whether triggered events are glitches or not.
- Our project focuses on **a tool useful for commissioning.**

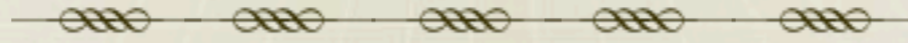

- **Event detection pipelines (K)**
- **Future selection statistics (t- or z- statistics) (K)**
- **To measure channels' responsibility for noise events**
- **Classification of noise events (J)**
- **Integrating these information, localize the noise sources.**

**Develop the pipeline using CLIO data, and LIGO, Virgo data.**

**o First Exam is to localize hardware injection we generated last CLIO operation.**

**o**

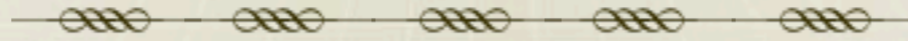

- There are several discussions
  - The Shadow monitor to reduce effects of violin modes.  
Evaluate what impact the monitor gives on data analysis?
  - Correlated environmental noise in global detector network.
  - Calibration accuracy