

Report on KAGRA detector characterization

Detector characterization group

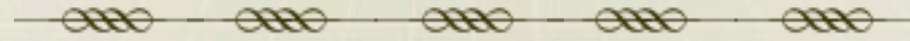

- **Evaluation of data quality**
- **Determine which data segment is available for science.**
- **Support diagnostics: --> help to shorten the commissioning period finding non-stationary components, artificial lines in channels. It will help to kill noise sources before KAGRA observing.**
- **Distribution of Veto information**
- **Detchar system in a pre-process server.**
- **Evaluation/setting of PEMs with GIF**
- **System to distribute veto info to other collaborations.**
- **The unique information of KAGRA should be taken care within detchar so that other collaborators are not concerned about it to some extent.**

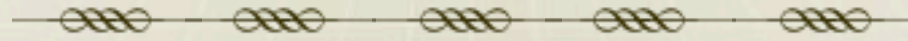

KAGRA GW telescope

PEM, Aux. channels, Online-monitors, diagnostics

Detector Characterization

Veto info, target veto, Data quality, calibration accuracy

Data Analysis

- **Channels: Interfaced with many subsystems**

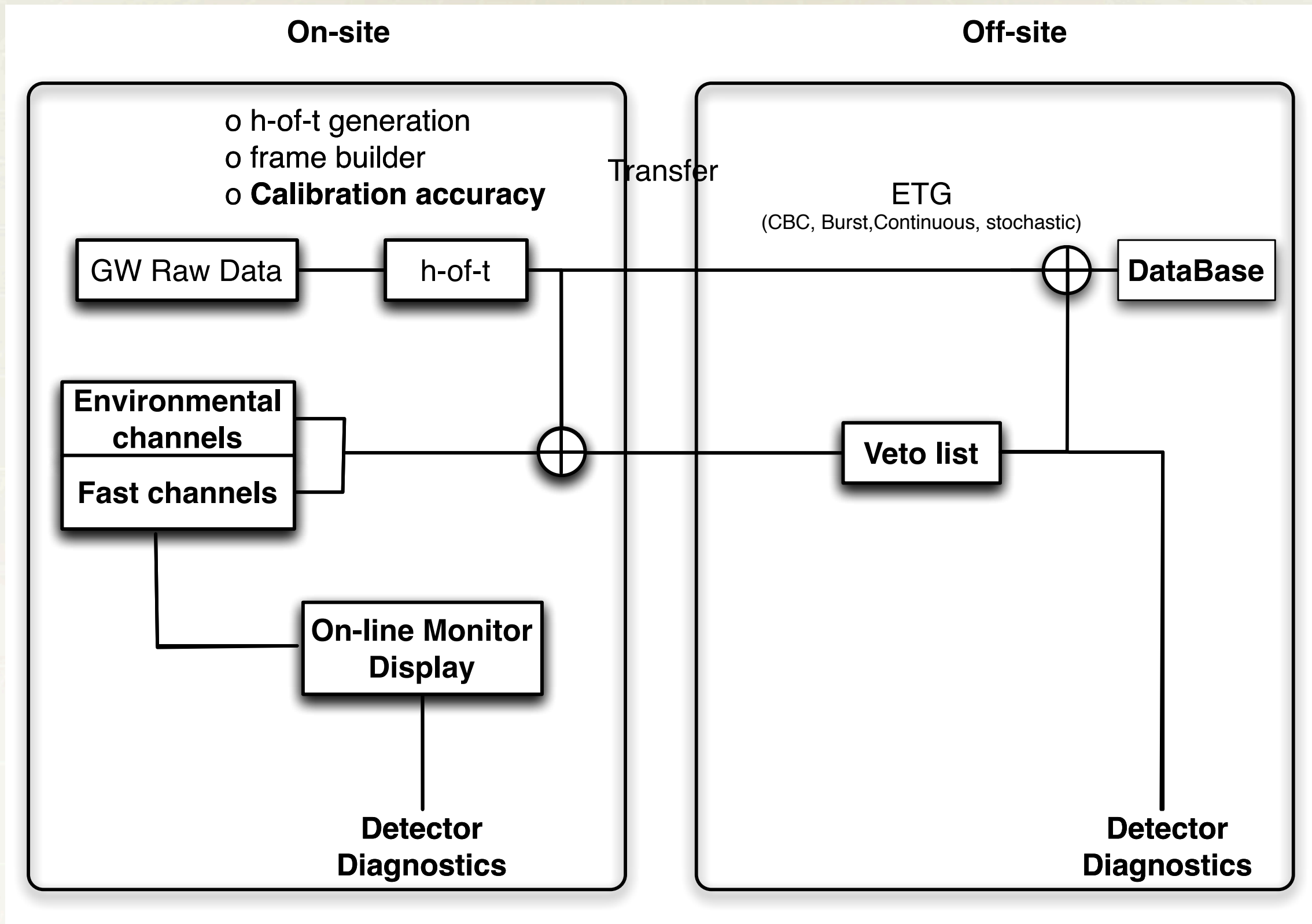
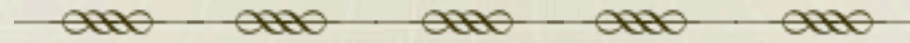

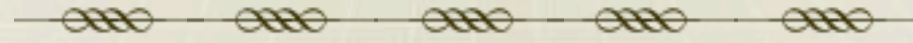

Selecting Physics and Environmental Monitor (PEM) (GIF)

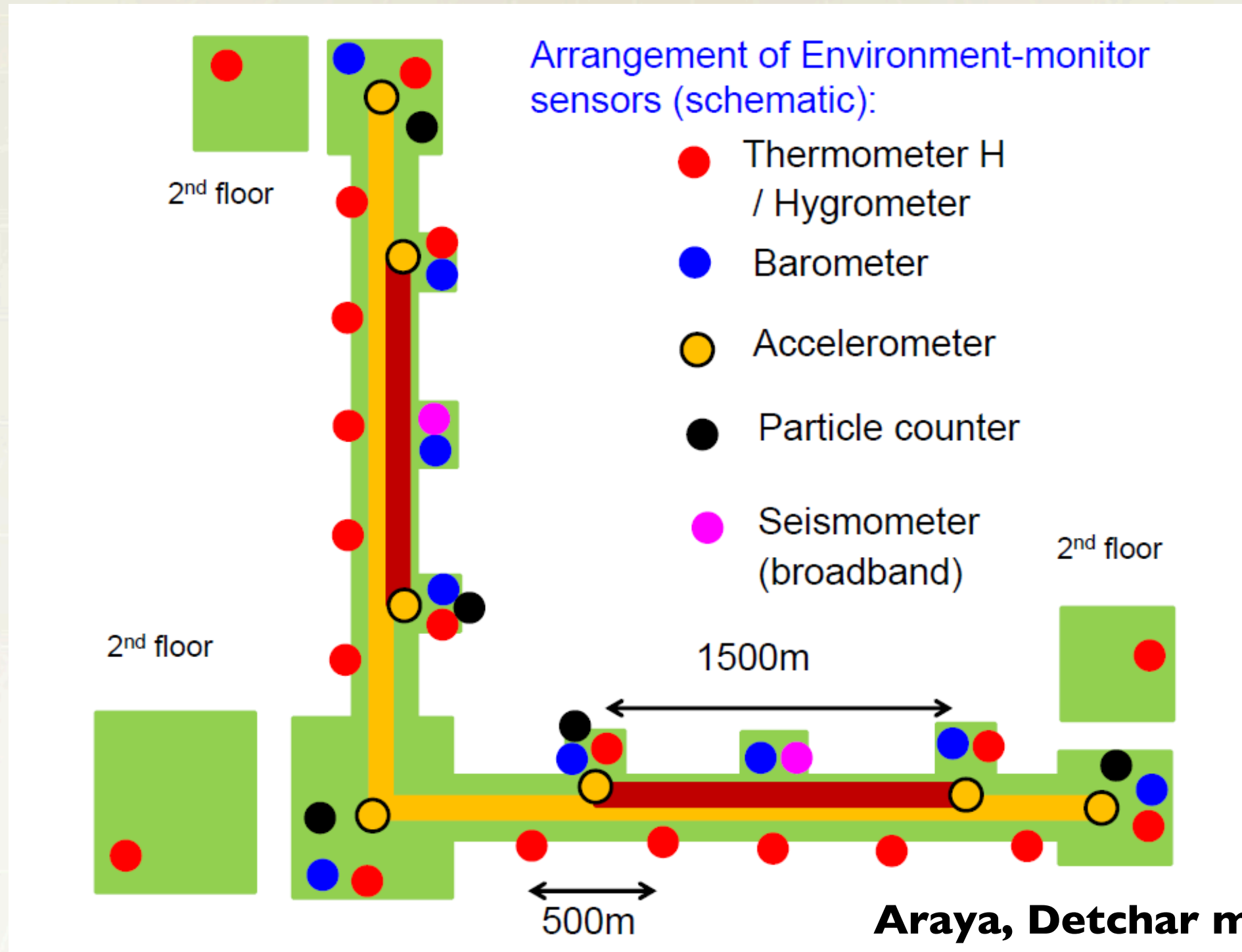

**Araya, Detchar meeting
in May 2012**

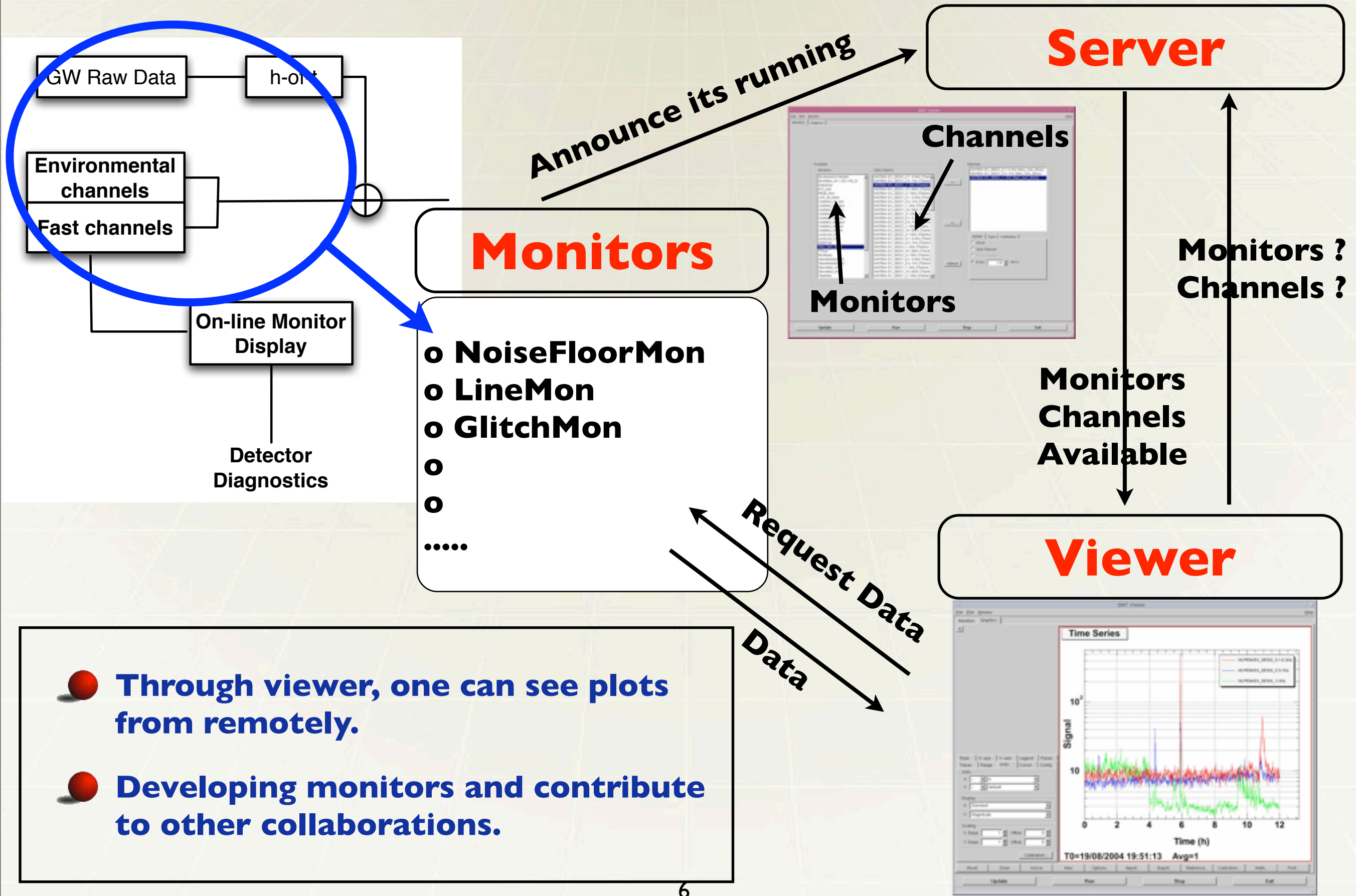

- Through viewer, one can see plots from remotely.
- Developing monitors and contribute to other collaborations.

NAOJ Developing the system on digital at NAOJ

Hayama(NAOJ), Miyakawa(ICRR), Yamamoto, Yuzurihara(OCU), Susa(Titech), Dan (UT)

- **Simple standalone system** (RT PC + ADC, Client WS, router) has been **delivered to NAOJ** on 12/6/2011.
- 3days work for installation, lecture and training
- **Online analysis software** will be developed by DAS group.



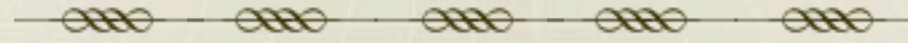

- **Data quality information**
- **Real-time segment-database generation**
Data quality information of science mode, lock, calibration, ...
- **Categorization**
- **Triggered event database**
- **Real-time veto analysis**
- **Daily Report tool**

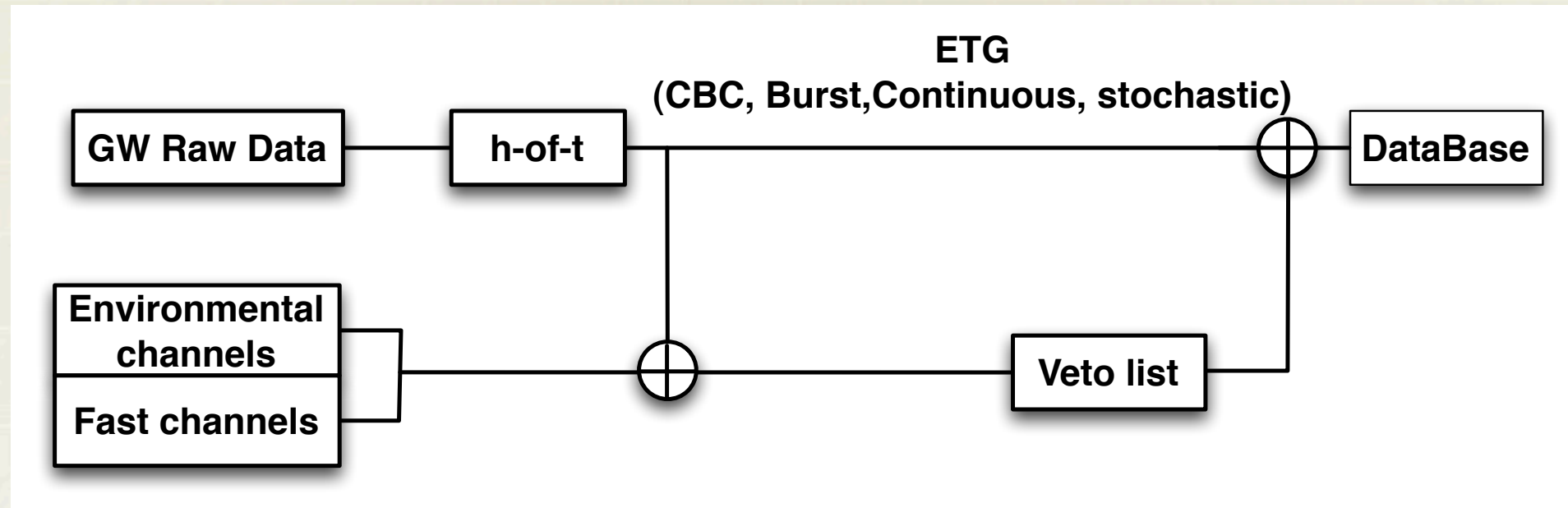

Veto list generation

Transient GW (CBC, Burst)

- Real-time glitch detection
- Glitch classification
- Coincidence analysis between the GW channel and auxiliary sensor channels.
- ...

Continuous GW (pulsar, LMXB, ...)

- Line tracking
- Line detection
- Removal of high frequency spikes
- ...

Stochastic GW (Early Univ, ...)

- Noise floor monitor
- Non-stationary
- ...

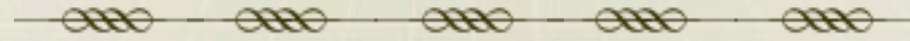

- **Import of LVC software**

- **Data quality monitor (Not all, but some)**

- **Glitch detection pipeline (Several pipelines, need sophistication in progress.)**

- **Coincidence analysis pipeline <- collaboration with UTB**

- **New software requirement / sophistication**

- **Noise modeling (power spectrum and, probably, glitch) (New method developed. Next slide)**

- **Multivariate analysis <- collaboration with Korea GW.**

- **Glitch classification (One paper accepted.)**

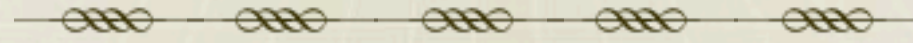

0.6

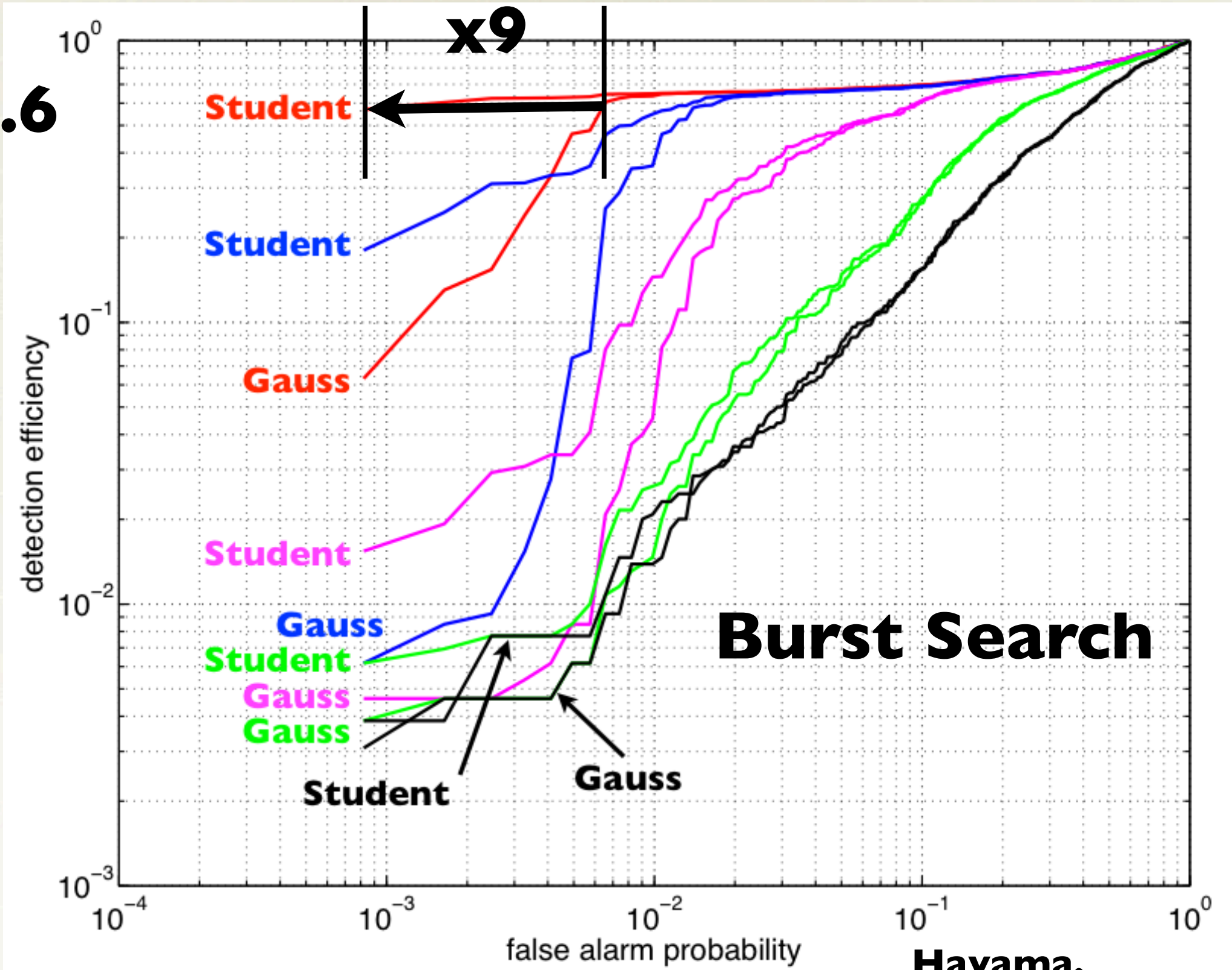

**Hayama,
paper submission ready**

Application of ANNs to Glitch Identification

Study using Auxiliary Channels

John J. Oh¹, Sang Hoon Oh¹, Young-Min Kim^{1,2}, Chang-Hwan Lee²,
Edwin J. Son³, Ruslan Vaulin⁴, Lindy Blackburn⁵

¹ National Institute for Mathematical Sciences ² Pusan National University
³ Sogang University ³ MIT ⁴ Goddard Space Flight Center, NASA

Goals: Applying artificial neural networks (ANNs) to auxiliary channel information,

- ◆ Provide a highly efficient and reliable noise transient (glitch) identification tool
- ◆ Develop a method to trace down the culprit channel(s) causing noise transient in strain data
- ◆ Potentially establish a new ranking statistic useful for CBC search

Trying improvement

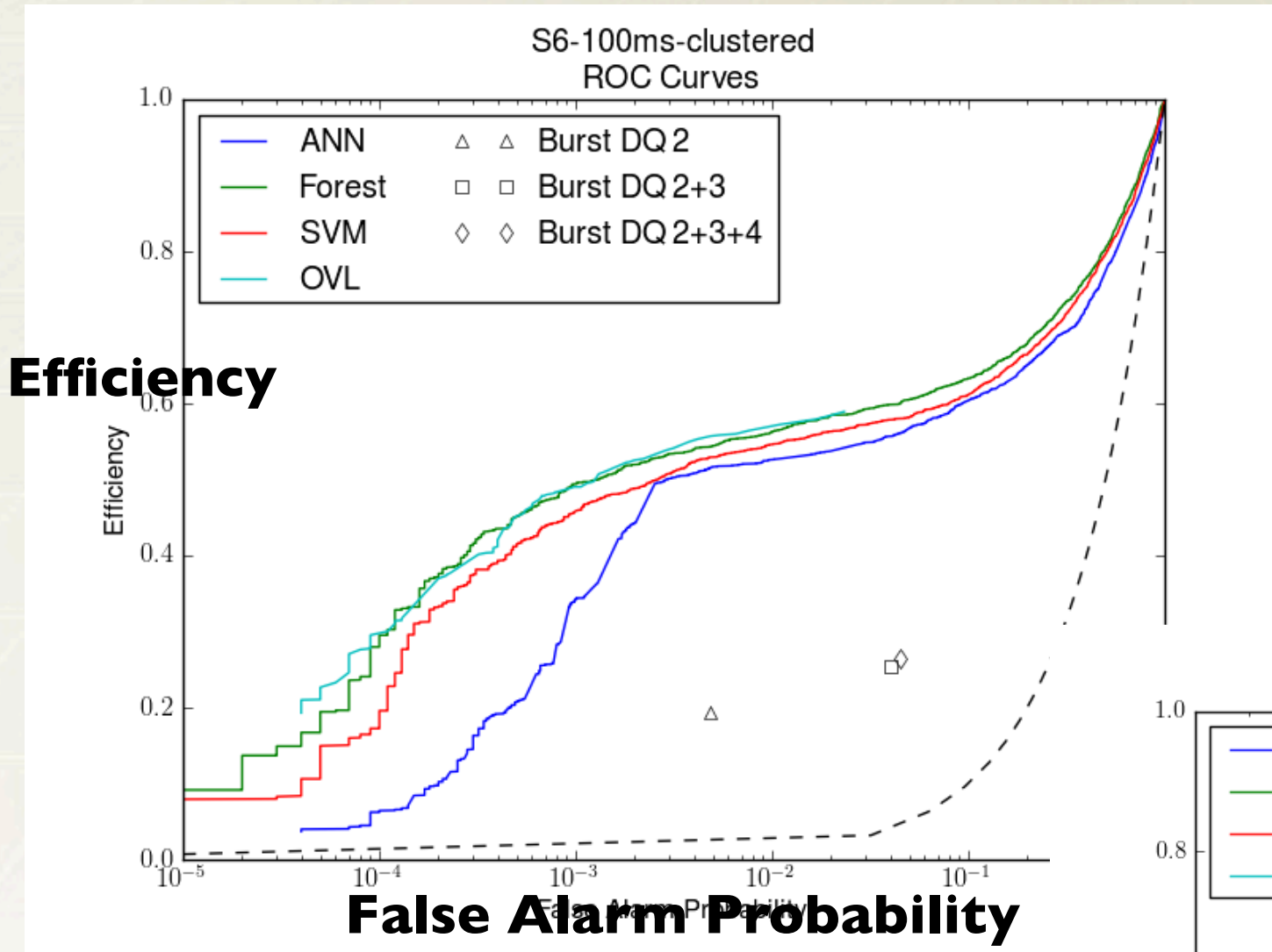
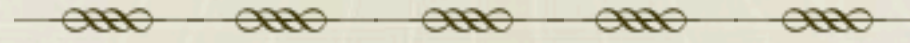

Hodge, K. in GWPAW2012

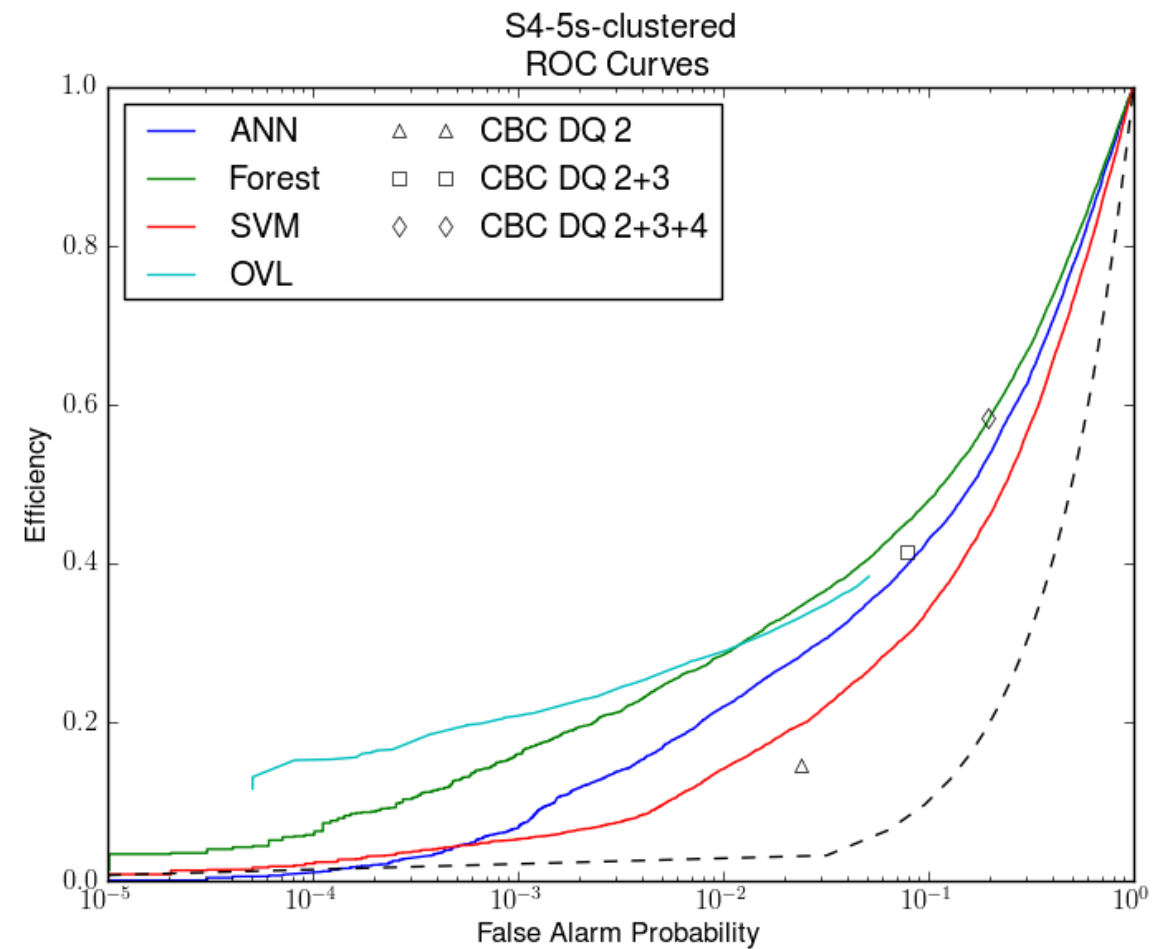

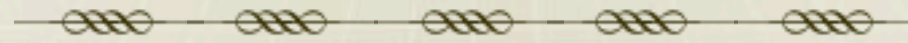

I. **Prototype test in CLIO**

- o Installation test of detchar basic system at NAOJ.
- o Test operation of detchar basic system during CLIO operation.
- o Software development.

Will do ~this fall.

II. **Computation platform**

- o 2Q-4Q2014: Implementation of detchar system in a pre-process server.
- o 1Q-3Q2015: Installation of the pre-process server to a building.

III. **Test operation**

- o Operation of the detchar system during GIF operation from ~ June, 2015.
- o Operation during iKAGRA in ~ Nov. 2015.
- o Software development

IV. **Operation**

- o Operation during bKAGRA from ~ Aug. 2018.