

# **Report on KAGRA detector characterization**

**Detector characterization group**

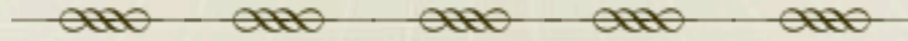

- **Evaluation of data quality**
- **Determine which data segment is available for science.**
- **Support diagnostics: --> help to shorten the commissioning period finding non-stationary components, artificial lines in channels. It will help to kill noise sources before KAGRA observing.**
- **Distribution of Veto information**
- **Detchar system in a pre-process server.**
- **Evaluation/setting of PEMs with GIF**
- **System to distribute of veto info to other collaborations.**
- **The unique information of KAGRA should be taken care within detchar so that other collaborators are not concerned about it to some extent.**

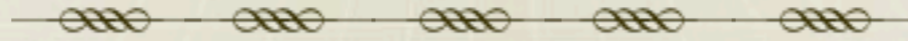

## KAGRA GW telescope

PEM, Aux. channels, Online-monitors, diagnostics

## Detector Characterization

Veto info, target veto, Data quality, calibration accuracy

## Data Analysis

- **Channels: Interfaced with many subsystems**

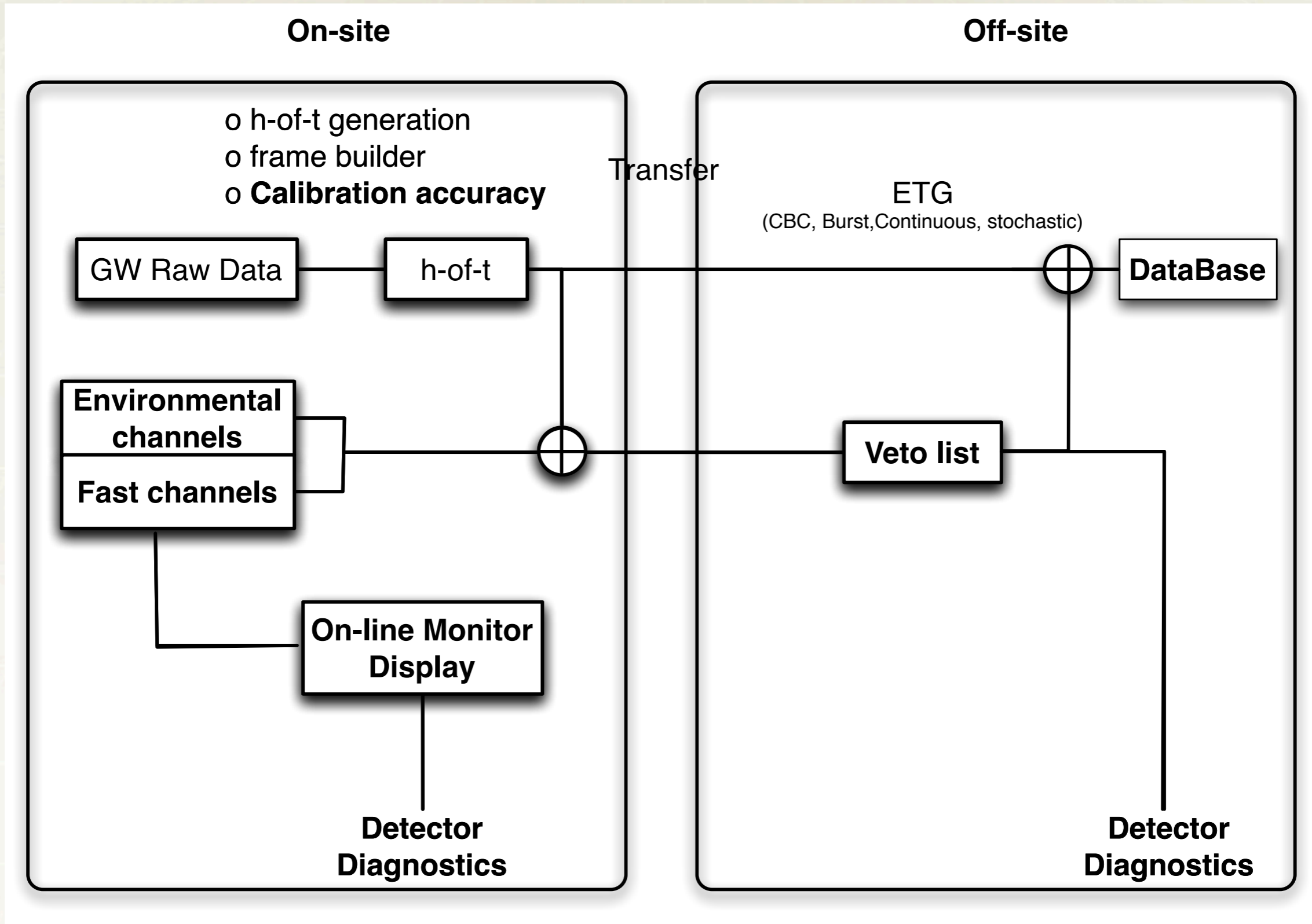
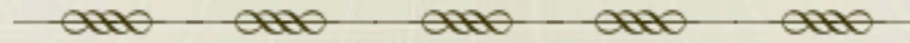

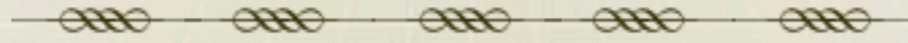

## Selecting Physics and Environmental Monitor (PEM) (GIF)

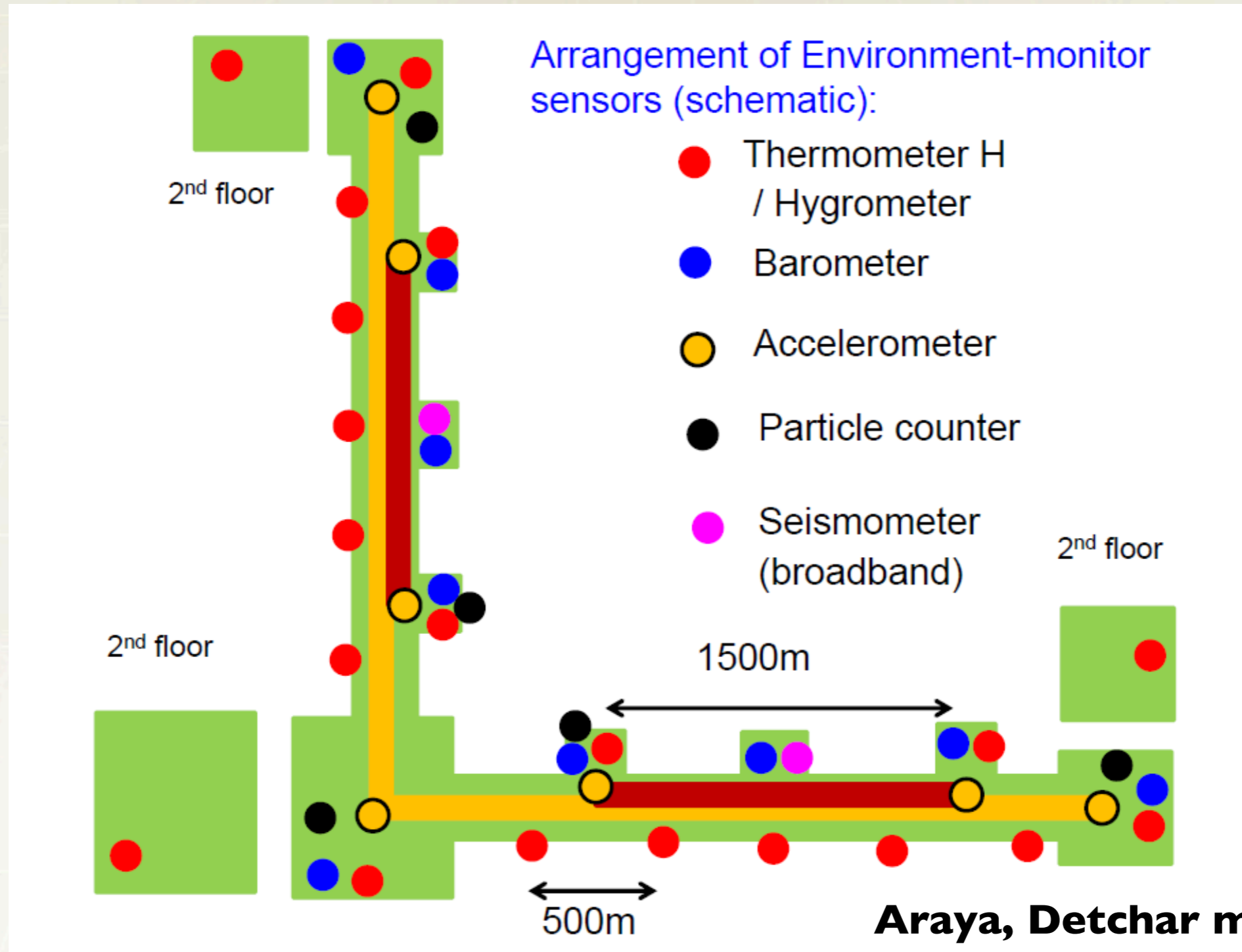

**Araya, Detchar meeting  
in May 2012**

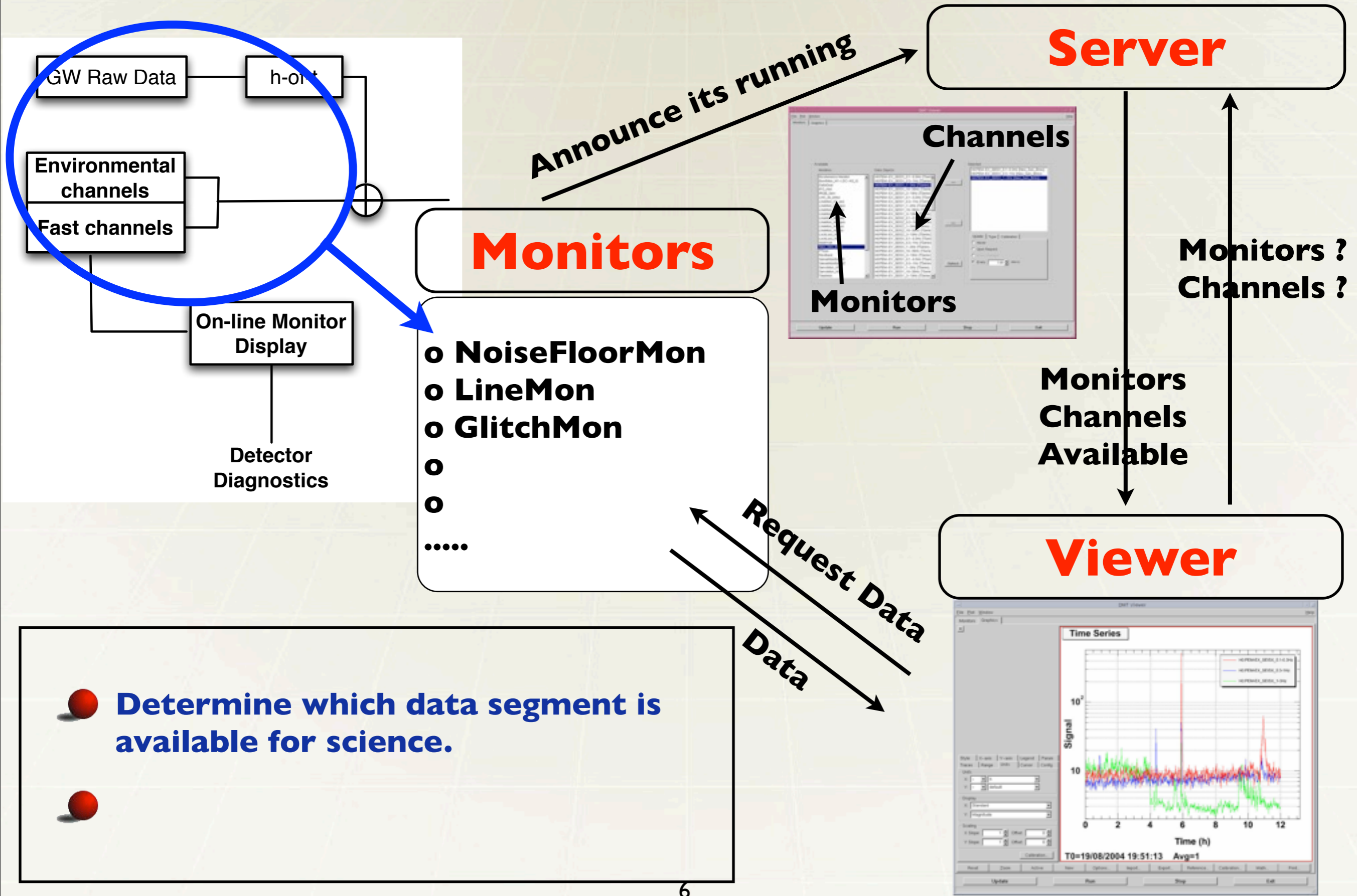

# NAOJ Developing the system on digital at NAOJ

Hayama(NAOJ), Miyakawa(ICRR), Yamamoto, Yuzurihara(OCU), Susa(Titech), Dan (UT)

- **Simple standalone system** (RT PC + ADC, Client WS, router) has been **delivered to NAOJ** on 12/6/2011.
- 3days work for installation, lecture and training
- **Online analysis software** will be developed by DAS group.



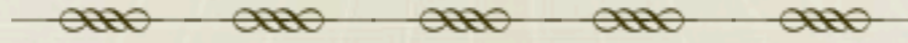

- **Data quality information**
- **Real-time segment-database generation**  
**Data quality information of science mode, lock, calibration, ...**
- **Categorization**
- **Triggered event database**
- **Real-time veto analysis**
- **Daily Report tool**



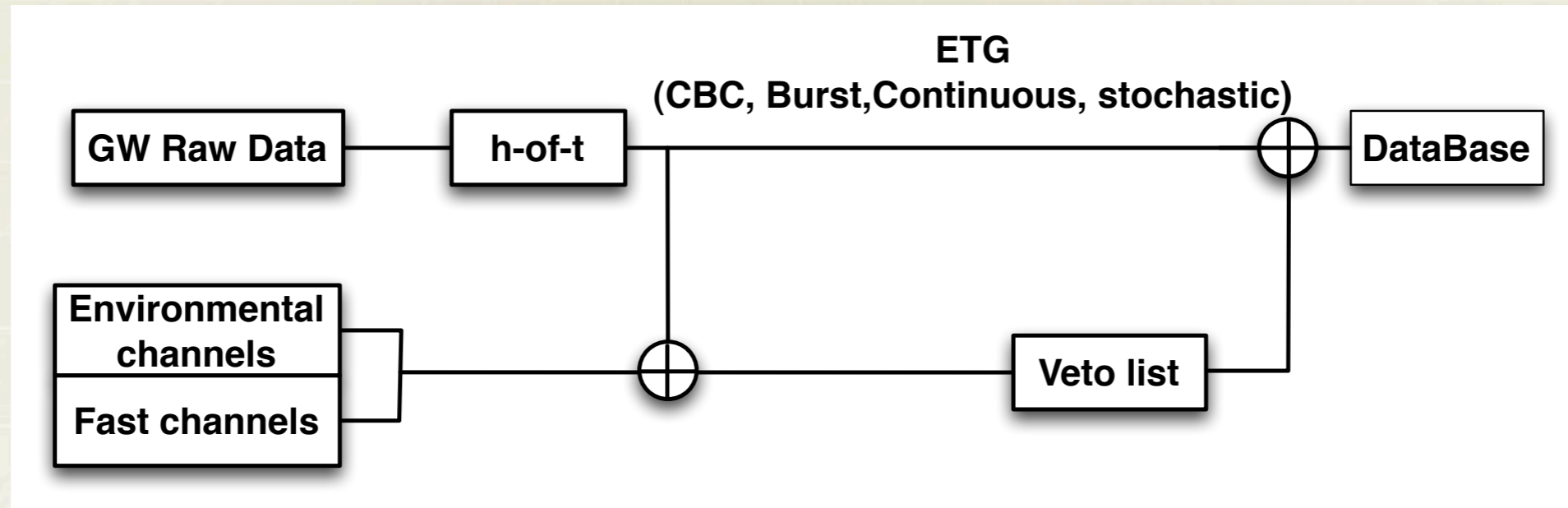

## Veto list generation

### Transient GW (CBC, Burst)

- Real-time glitch detection
- Glitch classification
- Coincidence analysis between the GW channel and auxiliary sensor channels.
- ...

### Continuous GW (pulsar, LMXB, ...)

- Line tracking
- Line detection
- Removal of high frequency spikes
- ...

### Stochastic GW (Early Univ, ...)

- Noise floor monitor
- Non-stationary
- ...

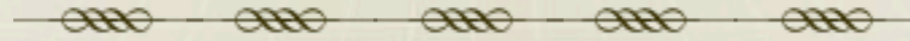

- **Import of LVC software**

- **Data quality monitor (Not all, but some )**

- **Glitch detection pipeline (Several pipelines, need sophistication in progress.)**

- **Coincidence analysis pipeline <- collaboration with UTB**

- **New software requirement / sophistication**

- **Noise modeling (power spectrum and, probably, glitch) (New method developed. Next slide)**

- **Multivariate analysis <- collaboration with Korea GW.**

- **Glitch classification (One paper accepted.)**

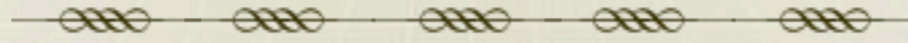

**0.6**

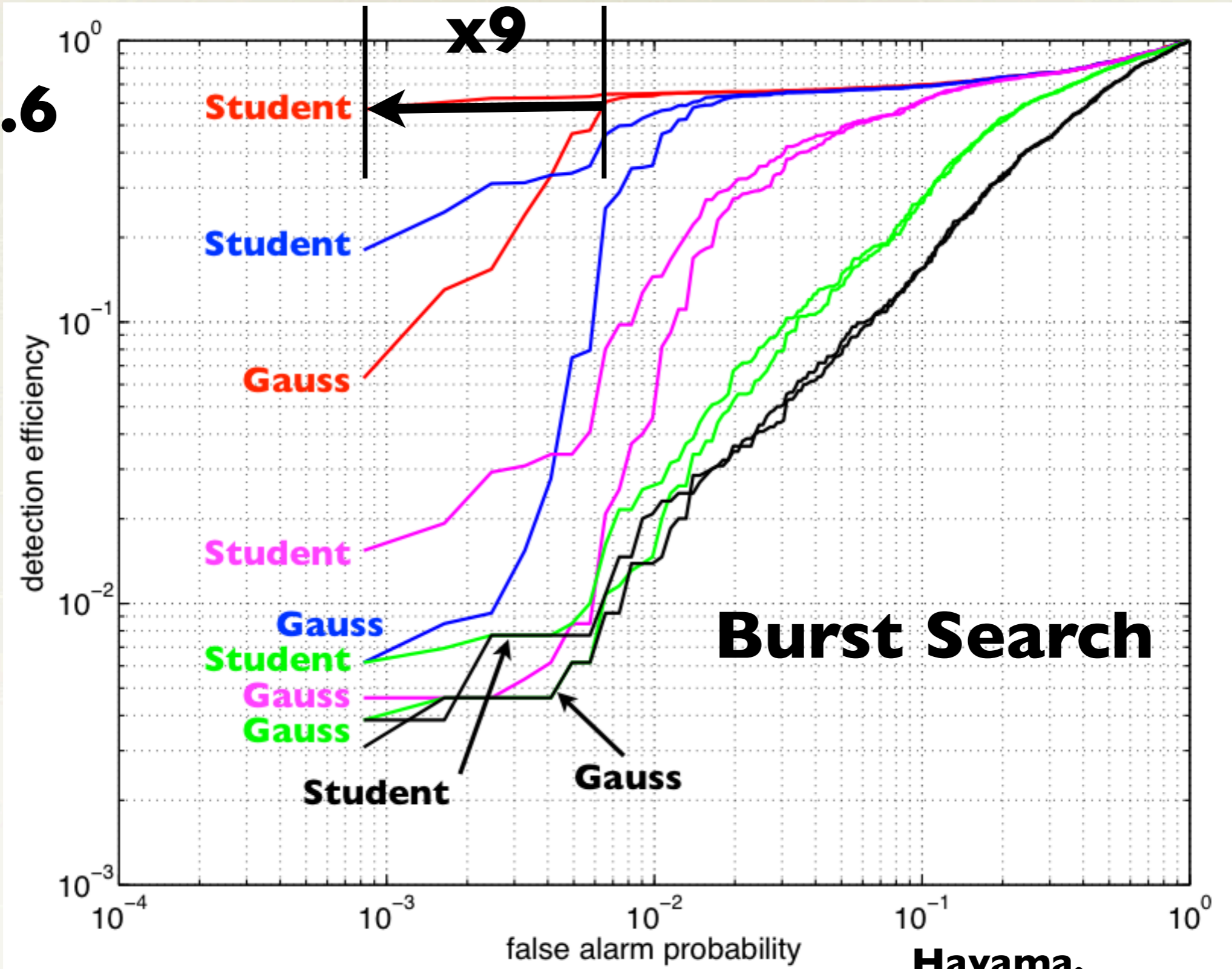

**Hayama,  
paper submission ready**

# Application of ANNs to Glitch Identification

## Study using Auxiliary Channels

John J. Oh<sup>1</sup>, Sang Hoon Oh<sup>1</sup>, Young-Min Kim<sup>1,2</sup>, Chang-Hwan Lee<sup>2</sup>,  
Edwin J. Son<sup>3</sup>, Ruslan Vaulin<sup>4</sup>, Lindy Blackburn<sup>5</sup>

<sup>1</sup> National Institute for Mathematical Sciences <sup>2</sup> Pusan National University  
<sup>3</sup> Sogang University <sup>3</sup> MIT <sup>4</sup> Goddard Space Flight Center, NASA

**Goals:** Applying artificial neural networks (ANNs) to auxiliary channel information,

- ◆ Provide a highly efficient and reliable noise transient (glitch) identification tool
- ◆ Develop a method to trace down the culprit channel(s) causing noise transient in strain data
- ◆ Potentially establish a new ranking statistic useful for CBC search

# Trying improvement

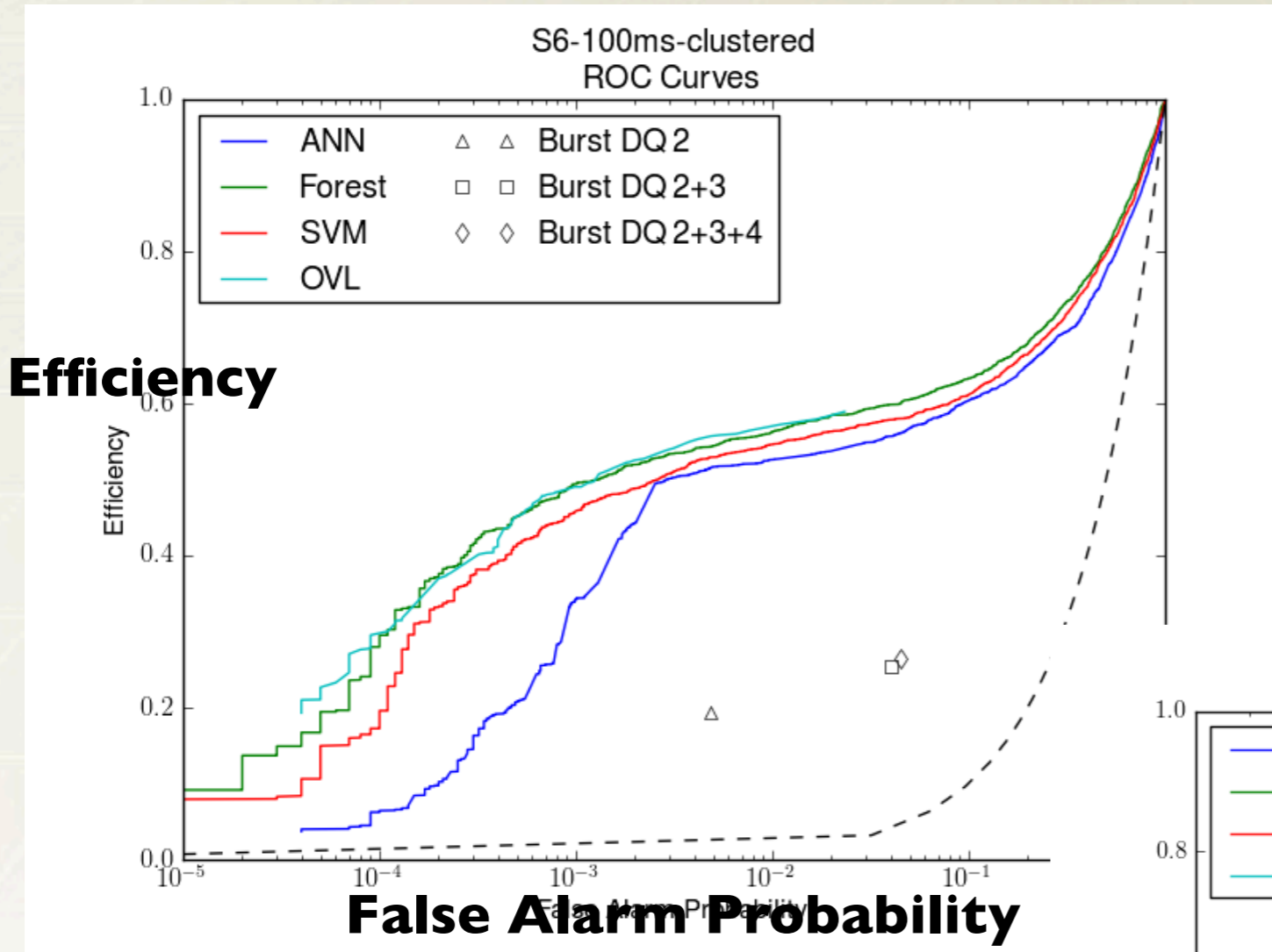
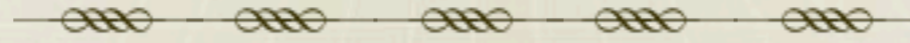

Efficiency

False Alarm Probability

Hodge, K. in GWPAW2012

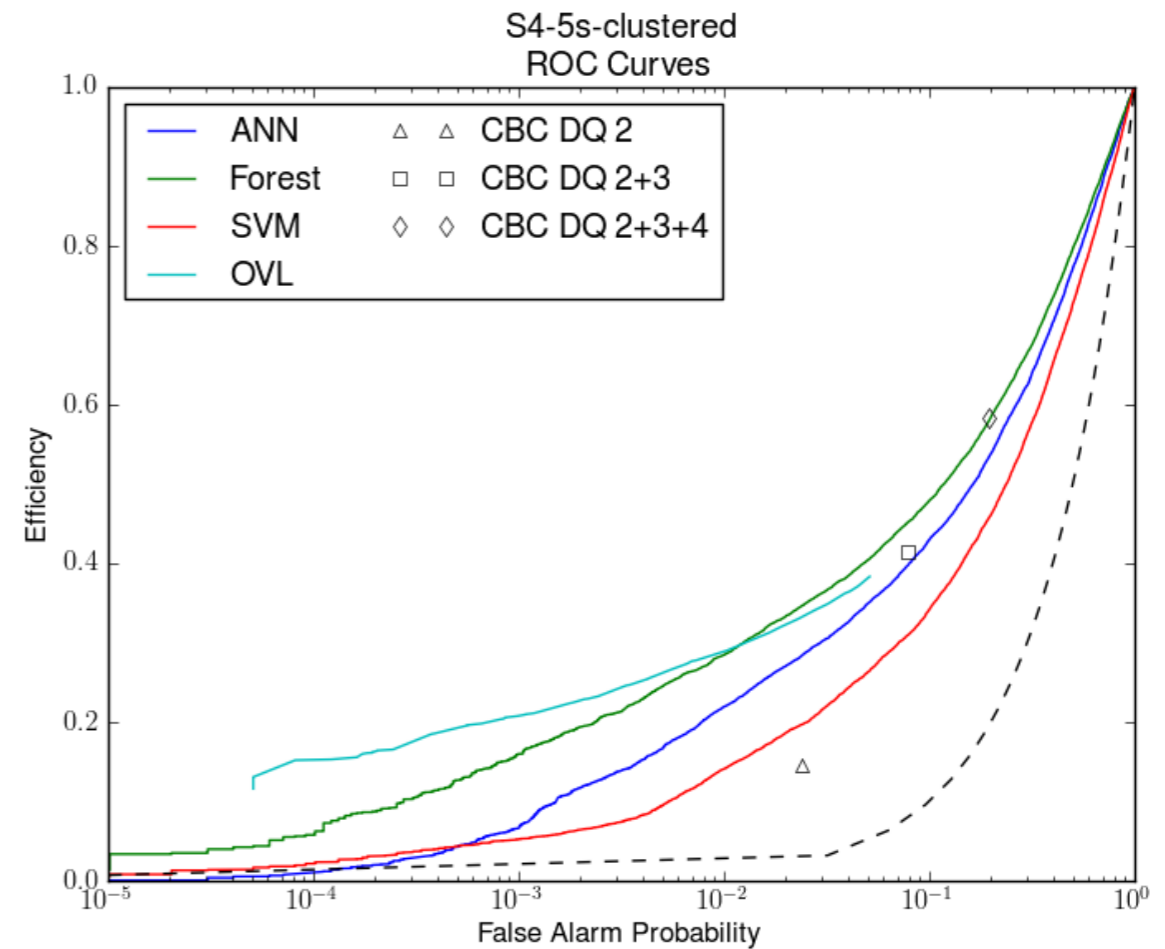

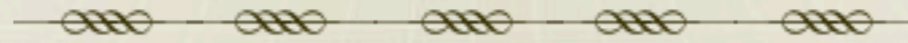

#### I. **Prototype test in CLIO**

- o Installation test of detchar basic system at NAOJ.
- o Test operation of detchar basic system during CLIO operation.
- o Software development.

Will do ~this fall.

#### II. **Computation platform**

- o 2Q-4Q2014: Implementation of detchar system in a pre-process server.
- o 1Q-3Q2015: Installation of the pre-process server to a building.

#### III. **Test operation**

- o Operation of the detchar system during GIF operation from ~ June, 2015.
- o Operation during iKAGRA in ~ Nov. 2015.
- o Software development

#### IV. **Operation**

- o Operation during bKAGRA from ~ Aug. 2018.