

Report on KAGRA detector characterization

Detector characterization group

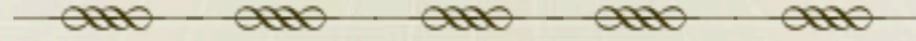

- Determine which data segment is available for science.**
- Detector diagnostics: finding non-stationary components in channels.
The best way is to kill noise sources before KAGRA observing.**
- Distribution of Veto information**

- Construction of detchar system in a pre-process server.**
- Evaluation/setting of EMs with GIF**
- Veto list**
- Distribution of veto list to other collaborations.**
- Influence of the accuracy of calibration on h-of-t reconstruction.**

- The unique information of KAGRA should be taken care with detchar and distributed so that other collaborators are not concerned about it to some extent.**

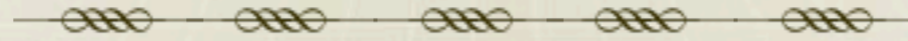

KAGRA GW telescope

PEM, Aux. channels, Online-monitors, diagnostics

Detector Characterization

Veto info, target veto, Data quality, calibration accuracy

Data Analysis

- **Channels: Interfaced with many subsystems**

Flow Chart

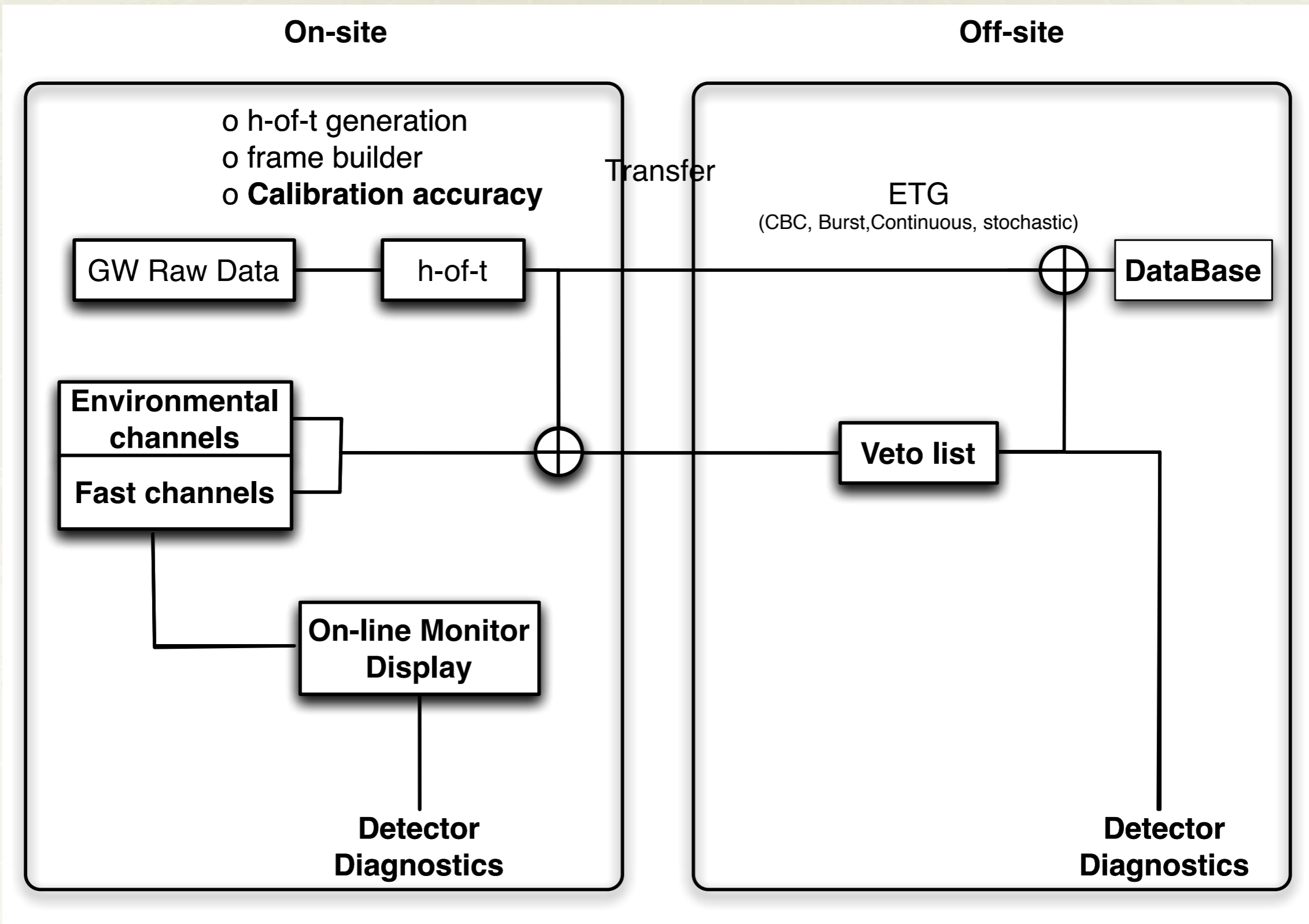
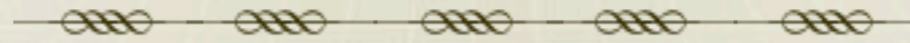

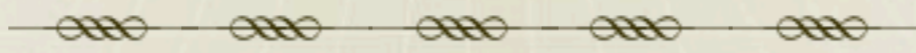

Selecting Physics and Environmental Monitor (PEM) (GIF)

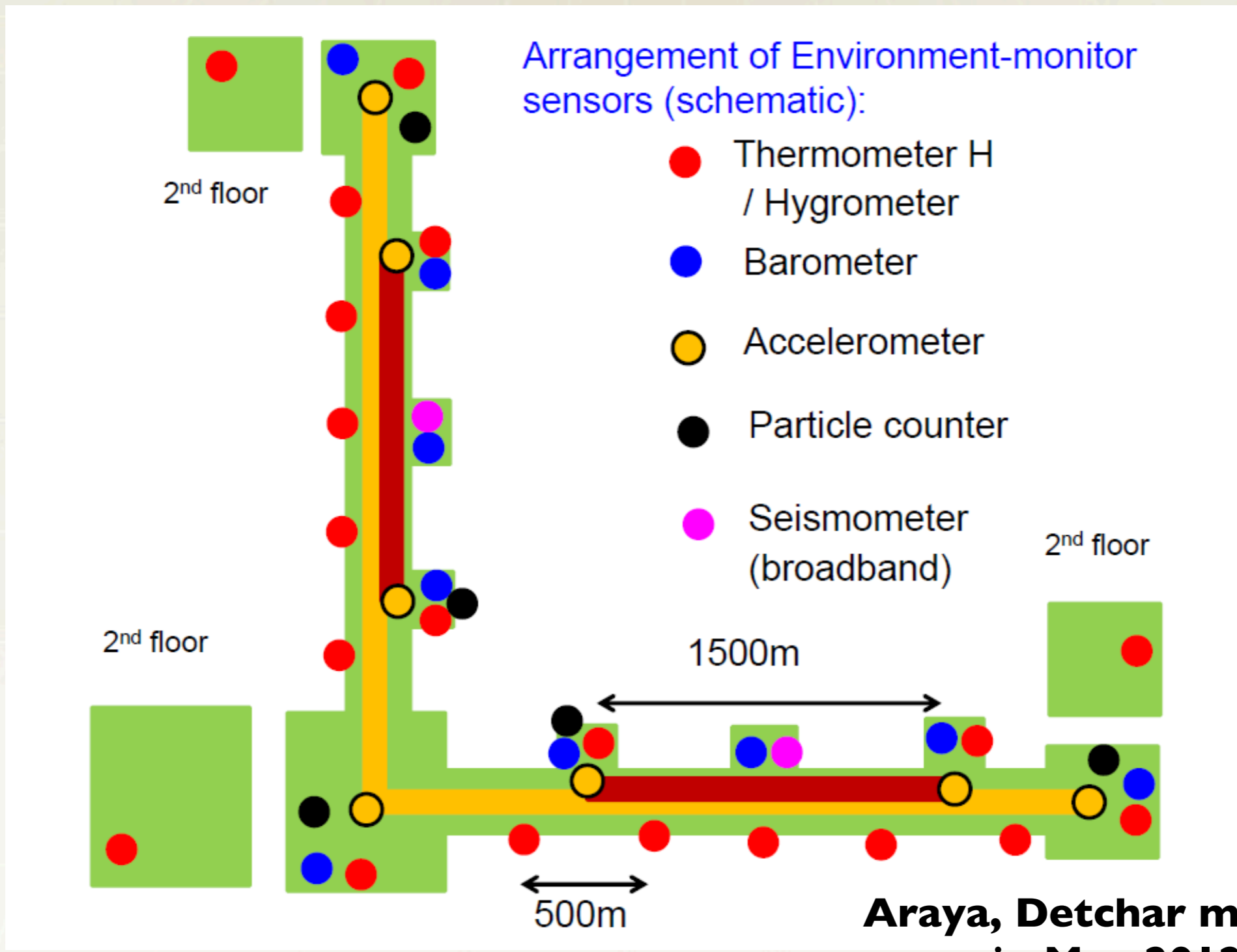

Araya, Detchar meeting in May 2012

Detchar Base System

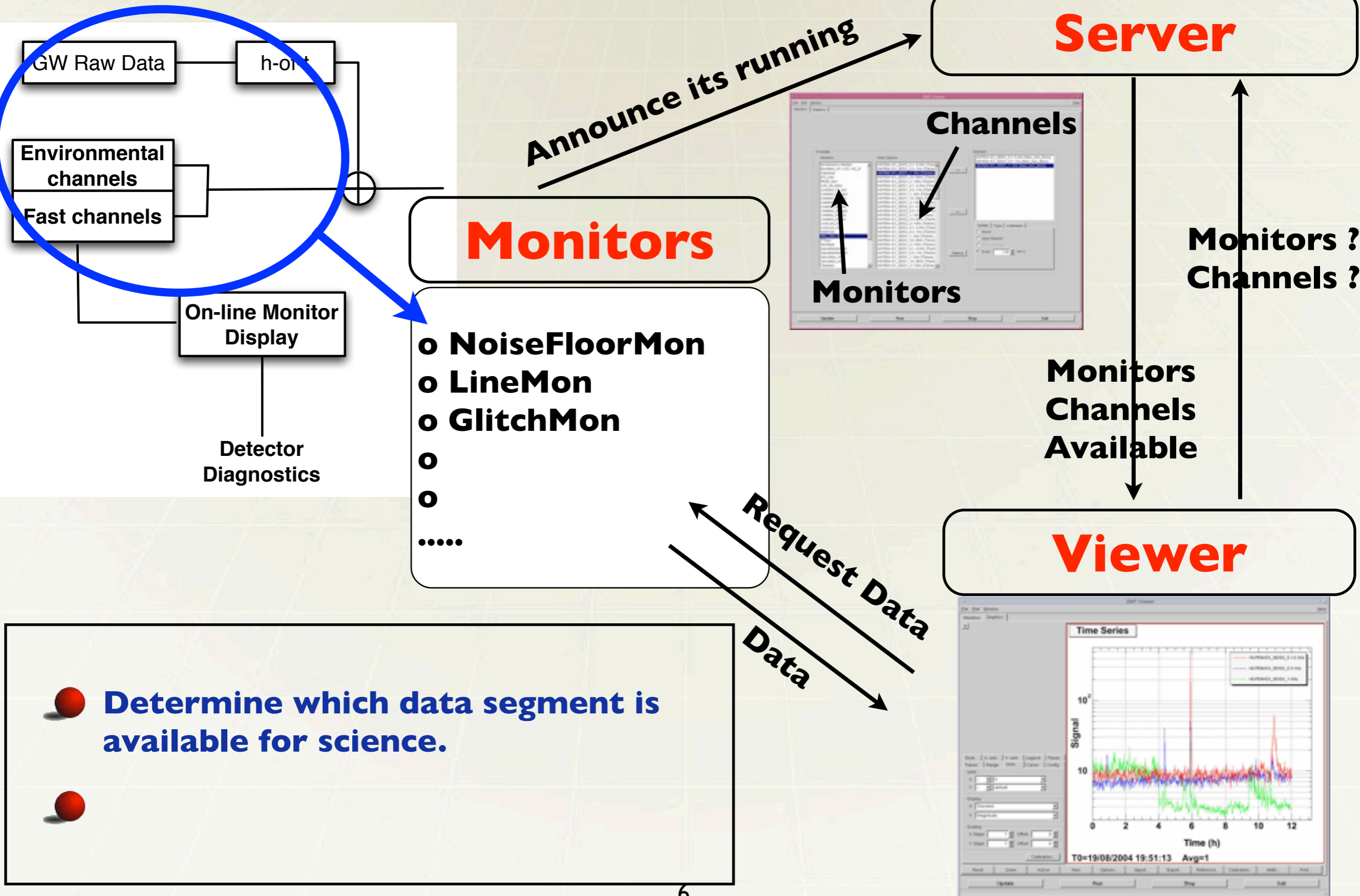

Hayama(NAOJ), Miyakawa(ICRR), Yamamoto, Yuzurihara(OCU), Susa(Titech), Dan (UT)

- **Simple standalone system** (RT PC + ADC, Client WS, router) has been **delivered to NAOJ** on 12/6/2011.
- 3days work for installation, lecture and training
- **Online analysis software** will be developed by DAS group.



Diagnosis on
Mac through
wireless LAN



RT PC + ADC

Client WS

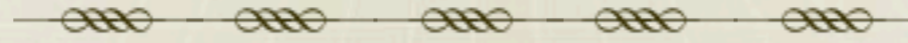

- Data quality information**
- Real-time segment-database generation**
Data quality information of science mode, lock, calibration, ...
- Categorization**
- Triggered event database**
- Real-time veto analysis**
- Daily Report tool**

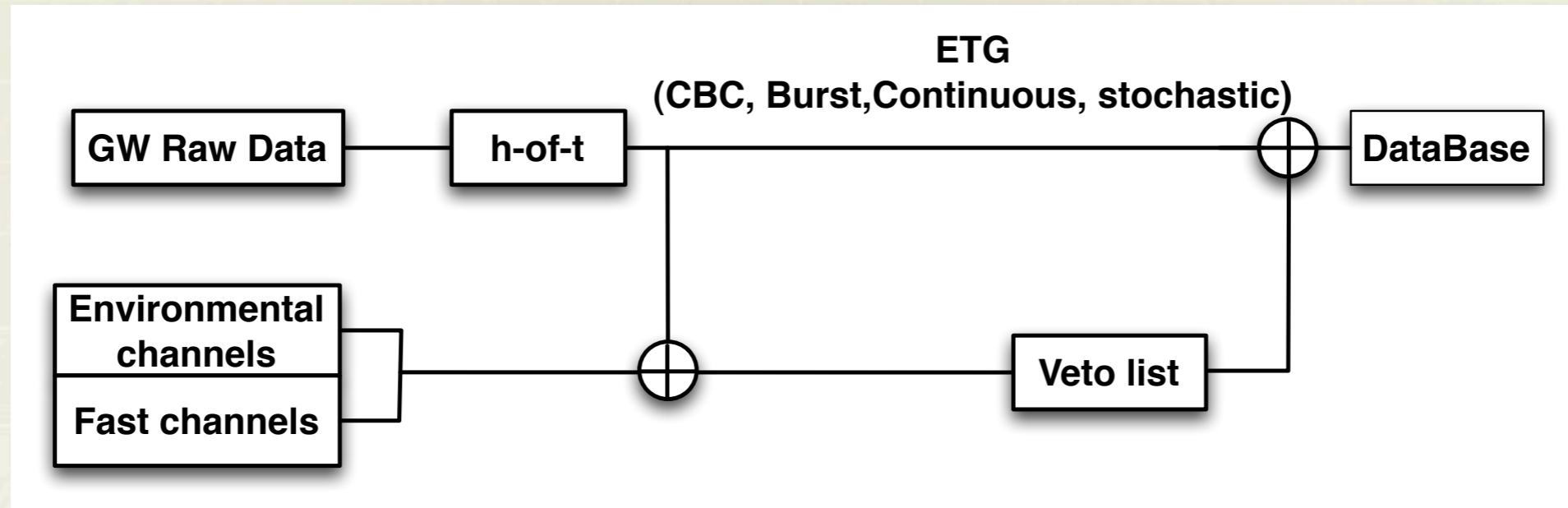

Veto list generation

Transient GW (CBC, Burst)

- Real-time glitch detection
- Glitch classification
- Coincidence analysis between the GW channel and auxiliary sensor channels.
- ...

Continuous GW (pulsar, LMXB, ...)

- Line tracking
- Line detection
- Removal of high frequency spikes
- ...

Stochastic GW (Early Univ, ...)

- Noise floor monitor
- Non-stationary
- ...

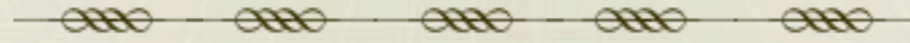

- **Import of LVC software**
 - **Data quality monitor**
 - **Glitch detection pipeline**
 - **Coincidence analysis pipeline**
- **New software requirement / sophistication**
 - **Glitch classification**
 - **Noise modeling (power spectrum and, probably, glitch)**
 - **Tools to know when and how glitches shows up?**
 - **Multivariate analysis**

Application of ANNs to Glitch Identification

Study using Auxiliary Channels

John J. Oh¹, Sang Hoon Oh¹, Young-Min Kim^{1,2}, Chang-Hwan Lee²,
Edwin J. Son³, Ruslan Vaulin⁴, Lindy Blackburn⁵

¹ National Institute for Mathematical Sciences ² Pusan National University

³ Sogang University ³ MIT ⁴ Goddard Space Flight Center, NASA

Goals: Applying artificial neural networks (ANNs) to auxiliary channel information,

- ◆ Provide a highly efficient and reliable noise transient (glitch) identification tool
- ◆ Develop a method to trace down the culprit channel(s) causing noise transient in strain data
- ◆ Potentially establish a new ranking statistic useful for CBC search

Trying improvement

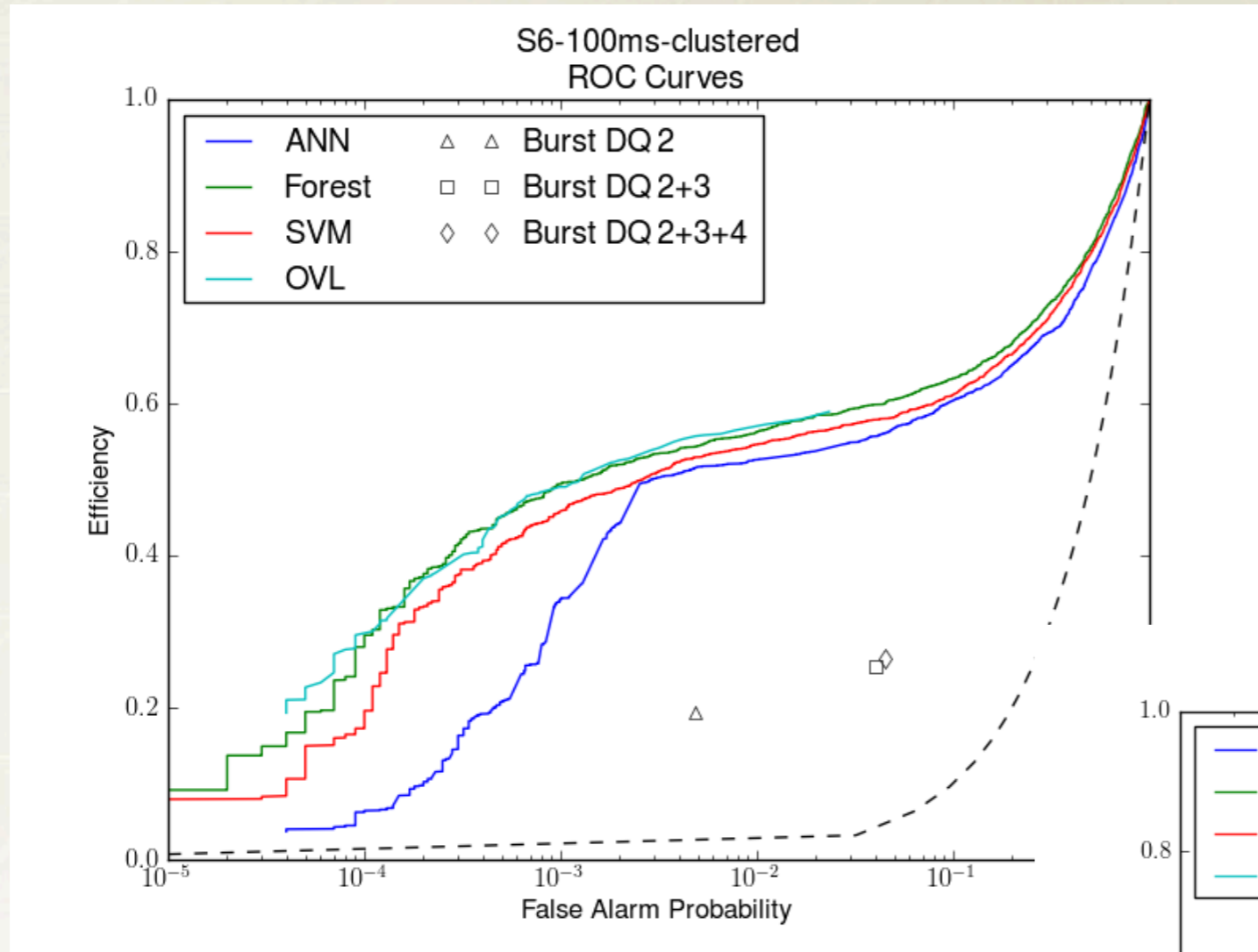
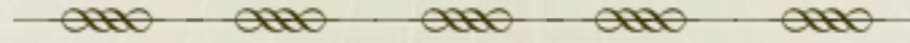

Hodge, K. in GWPAW2012

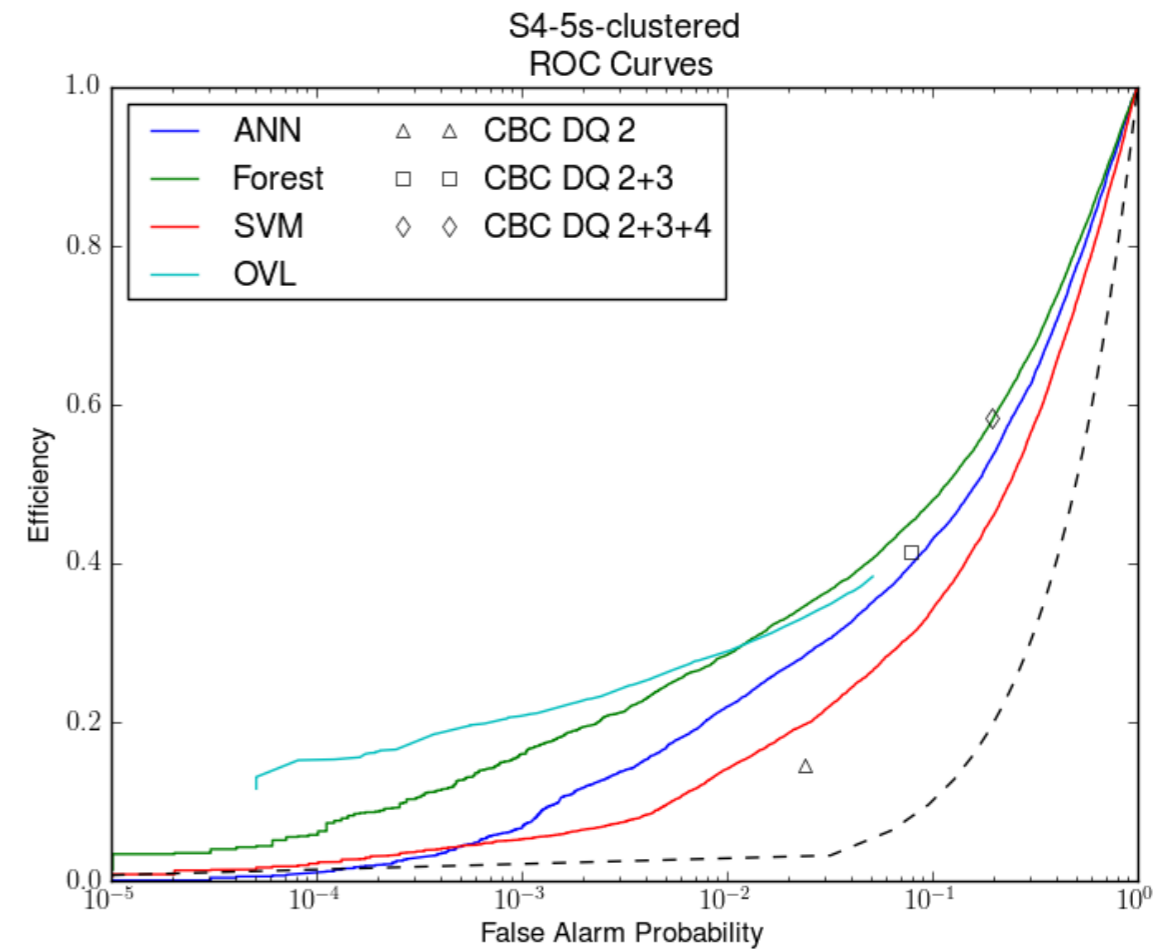

Activities of Korea DetChar

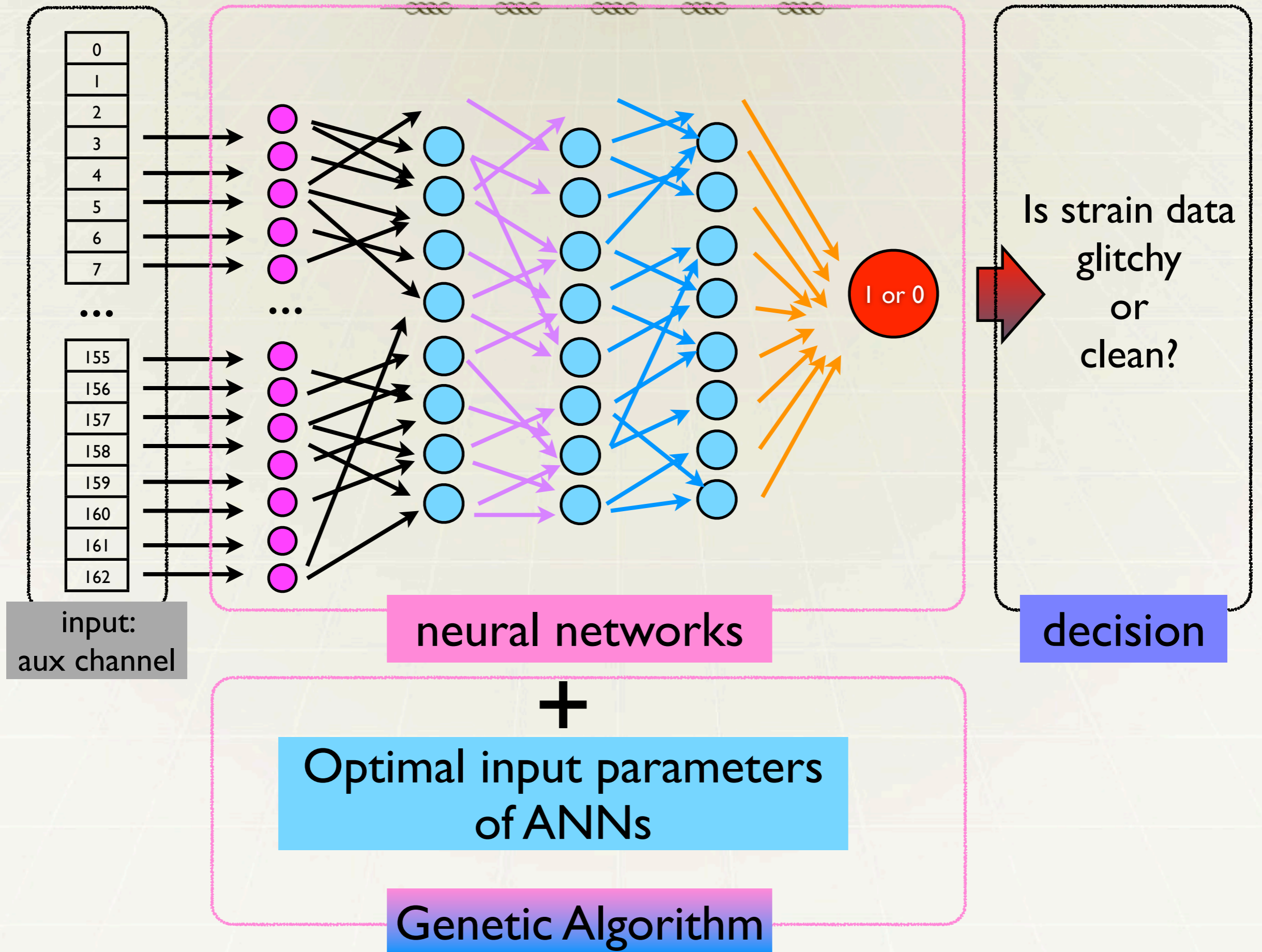

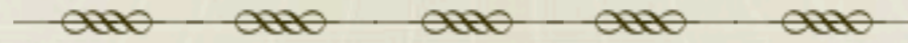

I. **Prototype test in CLIO**

- o Installation test of basic detchar system at NAOJ and soft development.
- o Test operation of basic detchar system during CLIO operation.
- o Software development

II. **Computation platform**

- o 2Q-4Q2014: Implementation of detchar system in a pre-process server.
- o 1Q-3Q2015: Installation of the pre-process server to a building.

III. **Test operation**

- o Operation of the detchar system during GIF operation from ~ June, 2015.
- o Operation during iKAGRA in ~ Nov. 2015.
- o Software development

IV. **Operation**

- o Operation during bKAGRA from ~ Aug. 2018.

Risk Management

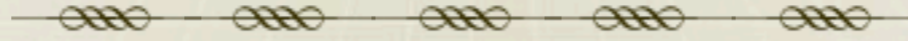

Schedule

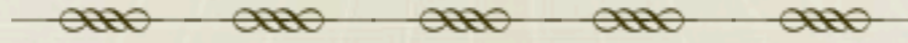

- **Visit MINS for collaboration on ANN.**
-