

Interface Control Document of the LCGT Project

2009/9/6 (ver 1.1)

LCGT Project

Foreword

This document, Interface Control Document (ICD), defines the interfaces among the subsystems constituting the LCGT (Large scale Cryogenic Gravitational wave Telescope). LCGT project is now in the phase of detailed design which includes finalizing the detailed parameters. That means the interfaces are changing literally day by day; which explains why this document is being updated frequently – every 2 weeks or so. This process of updating the interface will continue until the completion of the LCGT or even beyond. The authorization of the parameter changes will be given at the LCGT collaboration meeting which is held every two weeks.

An Interface Control Document generally defines only the interface between the whole system and its users, but we have chosen a different way to minimize the number of documents thus reducing our workload. As a result, this ICD also includes a brief description of the subsystem and the requirements for each of the subsystems, because we intend to expand this document, in the near future, into covering the Configuration Control Document as well.

This ICD currently is for providing each of the subsystem members of the LCGT project with the knowledge of other subsystem's interface parameters and requirements, but it will, as mentioned above, hopefully play in the future the role of describing the design parameters of the whole system.

One may refer to the “LCGT Design Document” for clarifying the premises and the process of determining the parameters given in this ICD which includes only the result of designing, not its process.

Finally let me express my sincere respect and appreciation for all the LCGT members who have contributed to this document and will continuously update it in the future. Let me specifically emphasize that Dr. Osamu Miyakawa has done a great job for providing the computer tool and also for editing this document.

Ichiro Nakatani
Project Manager of LCGT,
Institute for Cosmic Ray Research
The University of Tokyo

Index

1. Laser Source Subsystem
2. Input Output Optics Subsystem
3. Interferometer Sensing And Control Subsystem
4. Digital Control Subsystem
5. Interferometer Support Subsystem
 - 5.1 Scattered Light Control
 - 5.2 60Hz Control
 - 5.3 Thermal Lensing Control
 - 5.4 Clean Environment
6. Vibration Isolation Subsystem
7. Cryocooler Subsystem
8. Vacuum Subsystem
9. Data Acquisition Subsystem
10. Analysis Center Subsystem
11. Data Analysis Subsystem

Subgroup Name	Laser Source Subsystem
Subgroup Leader	Norikatsu Mio The University of Tokyo

Doc version	Date	Description
Rev. A-0		

11.1 ① サブシステム:レーザー光源

レーザー光源サブシステムは、光源本体、電源、冷却系、制御系、モニター系、インターロックシステム(安全管理用)からなる。また、光源全体は、クリーン環境下におかれる。

② システムの所掌範囲

光源本体は、半導体レーザー励起 Nd:YAG レーザーをベースにした、注入同期レーザーシステムと光増幅器からなる。電源は、商用交流電源から励起 LD を駆動する安定化電源、制御系を駆動する安定化電源からなる。冷却系は、励起 LD とレーザー結晶を水冷する。制御系は、機械的・光学的な制御素子と制御用電気回路群からなる。モニター系は、レーザー装置の状態を見るための測定器類を総合して言う。インターロックシステムは、緊急事態に備えて、レーザー発振の安全な停止を行なうシステムである。

他のシステムとの接続

1.	出力光→入射光学系	光
2.	干渉計→制御信号系	電気信号
3.	モニター系→データ収録系	電気信号
4.	施設→電源	商用電源
5.	施設→冷却水系	水
6.	施設→インターロック系	電気信号
7.	施設→光源全体	クリーンルームの設置
8.	干渉計→インターロック系	電気信号

③ サブシステムへの要求仕様の整理

1. 出力:150 W
2. 波長:1064 nm
3. 周波数雑音@100Hz, $\delta\nu \leq 10^{-8} \text{ Hz}/\sqrt{\text{Hz}}$
4. 強度雑音@100Hz, $\delta I / I \leq 10^{-7} / \sqrt{\text{Hz}}$
5. 周波数制御帯域 >1 MHz
6. 入力端子:周波数制御、強度制御、インターロック

7. 出力信号:出力、制御信号レベル、温度、発振モード、内部情報
8. 電源:単相 200 V、150A(例起用 LD、冷却装置)
9. 電源:単相 100 V、100A(制御装置、モニター装置等)
10. クリーン度:クラス 100
11. 1次冷却水:15度、流量:TBD

④関連するサブシステム間のインターフェースの定義:

1. 出力光→入射光学系
 - 入射光学系の光学モードに合わせて、レーザービームの光学軸の位置・角度(アラインメント)、ビーム半径の調整。
 - アラインメント調整用のミラー角度はデジタル制御可能なマウントを用いる。
2. 干渉計→制御信号系
 - 周波数制御信号:アナログ信号、帯域1MHz
 - 強度制御信号:アナログ信号、大域 1MHz
 - インターロック:デジタル信号(DC 付近)
 - アラインメント制御:デジタル信号(DC 付近)
3. モニター系→データ収録系
 - 出力:アナログ信号(高速 10kHz)、デジタル信号(DC 付近)
 - 制御信号レベル:アナログ信号(高速 10kHz)、デジタル信号(DC 付近)
 - 温度:デジタル信号(DC 付近)
 - 発振モード:TBD
 - 内部情報:TBD
4. 施設→電源
 - 単相 200 V、150A
 - 単相 100 V、100A
5. 施設→冷却水系
 - 1次冷却水:15度、流量:TBD
6. 施設→インターロック系 電気信号
 - 非常事態通報:デジタル信号
7. 施設→光源全体 クリーンルームの設置
 - 光源全体は、独立したクリーンルーム内に設置
 - 出入り口のセンサーでインターロックを行なう

- 干渉計を収納する真空タンクにつながる入射窓フランジは、クリーンルーム内に設置
- 8. 干渉計→インターロック系 電気信号
- 非常事態通報: デジタル信号
- アンロック信号: デジタル信号

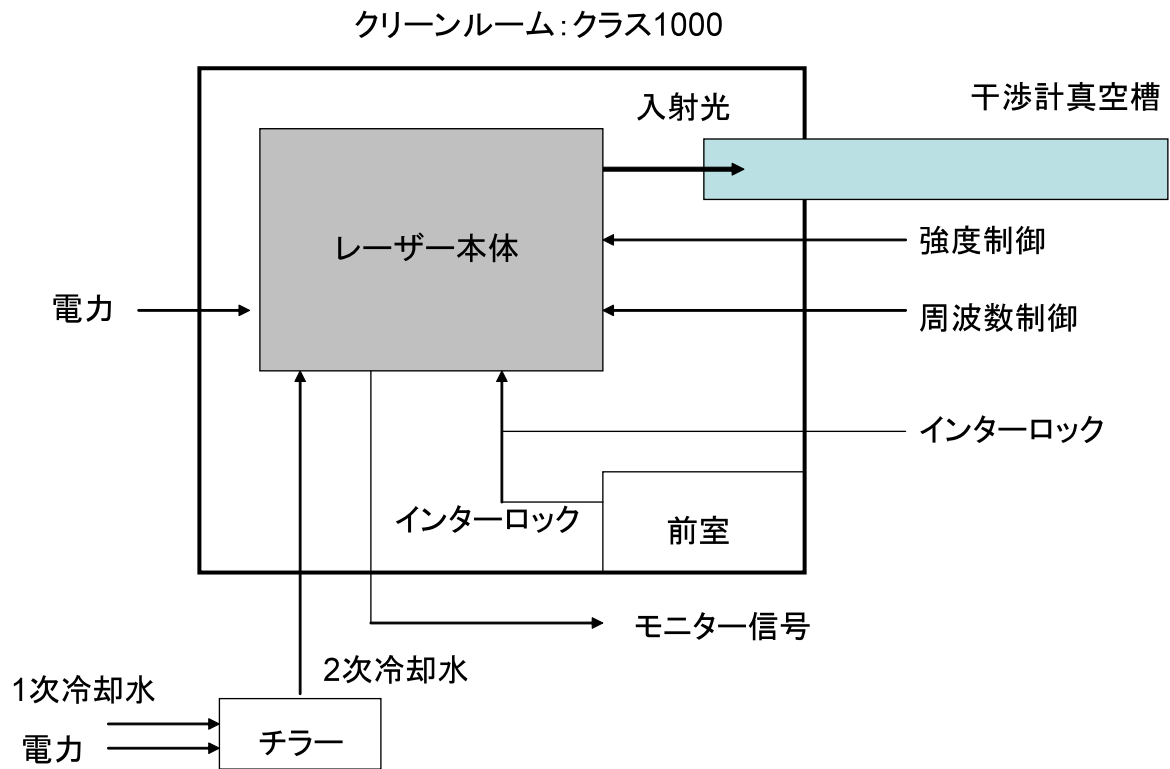

Interface Control Document of the LCGT Project

Subgroup Name	Input-Output Optics Subsystem (入射・射出光学系サブシステム)
Subgroup Leader	Shigenori Moriwaki The University of Tokyo

Doc version	Date	Description
Rev. A-1	2010-04-18	Kick-off draft

APPROVAL AUTHORITIES

用語集 / Glossary

AM	Amplitude modulation
MC	Mode cleaner
MMT	Mode matching telescope
FI	Faraday isolator
FN	Frequency noise
HWP	Half wave plate
PBS	Polarizing beam splitter
MZM	Mach-Zehnder modulator
PM	Phase modulation
PRM	Power recycling mirror
RIN	Relative intensity noise
SEM	Signal extraction mirror
WFS	Wave front sensing

1. 各サブシステムの簡単な定義 / Concise definition of **Input-Output Optics**

Subsystem

LCGT 建設完了までに各サブグループが責任を持って提供すべき機能と、それを実現するためのハードウェア、ソフトウェア。

No.	機能 / Function	ハードウェア・ソフトウェア / Hardware, software
1	Mode and RF Sideband Cleaner (MC1)	Suspended triangular ring cavity with 10m baseline in vacuum
2	Mode Cleaner (MC2)	Suspended triangular ring cavity with 15m baseline in vacuum
3	Phase Modulator for MC1(PMMC1)	Electro-Optic Modulator for 8MHz (TBD) on the input table
4	Faraday Isolator for MC1 (FI1)	Faraday rotator and polarizing beamsplitter in vacuum
5	Mode Matching Telescope for MC1 input (MMT1)	A pair of convex/concave mirrors mounted on the input table
6	Mode Matching Telescope between MC1 and MZM (MMT2)	A pair of convex/concave mirrors suspended in vacuum
7	Mach-Zehnder Modulator(MZM)	Mach-Zehnder interferometer which contains electro-optic modulators for 10MHz phase and 60MHz amplitude modulations
8	Faraday Isolator for MC2 (FI2)	Suspended Faraday rotator and polarizing beamsplitter in vacuum
9	Mode Matching Telescope for MC2 input (MMT3)	A pair of convex/concave mirrors suspended in vacuum
10	Mode Matching Telescope between MC2 and PRM (MMT4)	A pair of convex/concave mirrors suspended in vacuum
11	Output mode cleaner (OMC)	Rigid-body ring cavity which excludes deformed component of the anti-symmetric port beam
12	Mode Matching Telescope between SEM and OMC (MMT5)	A pair of convex/concave mirrors suspended in vacuum
13	Photo Detectors (PDs)	Length and wave front sensing photodetectors at the Dark Port, the Bright Port and the Pick-off Port

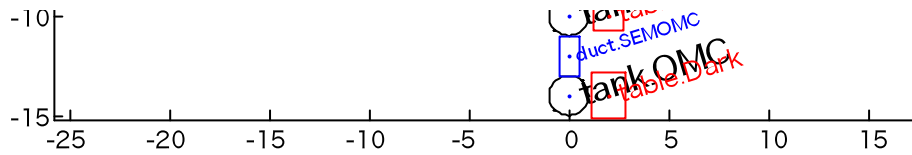

2. 要求仕様 / Required specifications for Input-Output Optics Subsystem

1で示した機能に対する要求仕様が記述されている LCGT design document version 2 での section 番号、関連 sub-system、Design document version 2 からの変更の有無と可能性。

No.	機能 / Function	Described section (**)	Related sub-system(s)	変更有り /modified	変更の可能性 有り/to be modified
1	Mode and RF Sideband Cleaner (MC1)	7.2, 7.3	Laser	<input type="checkbox"/>	<input type="checkbox"/>
2	Mode Cleaner (MC2)	7.2, 7.3	ISC	<input type="checkbox"/>	<input checked="" type="checkbox"/>
3	Phase Modulator for MC1(PMMC1)	7.3	Laser, ISC	<input checked="" type="checkbox"/>	<input checked="" type="checkbox"/>
4	Faraday Isolator for MC1 (FI1)	7.9	ISC	<input checked="" type="checkbox"/>	<input checked="" type="checkbox"/>
5	Mode Matching Telescope for MC1 input (MMT1)	Not yet	ISC	<input checked="" type="checkbox"/>	<input checked="" type="checkbox"/>
6	Mode Matching Telescope between MC1 and MZM (MMT2)	7.5	ISC	<input checked="" type="checkbox"/>	<input checked="" type="checkbox"/>
7	Mach-Zehnder Modulator(MZM)	7.7	ISC	<input type="checkbox"/>	<input checked="" type="checkbox"/>
8	Faraday Isolator for MC2 (FI2)	7.9	ISC	<input type="checkbox"/>	<input checked="" type="checkbox"/>
9	Mode Matching Telescope for MC2 input (MMT3)	7.5	ISC	<input type="checkbox"/>	<input checked="" type="checkbox"/>
10	Mode Matching Telescope between MC2 and PRM (MMT4)	7.5	ISC	<input checked="" type="checkbox"/>	<input checked="" type="checkbox"/>
11	Output mode cleaner (OMC)	7.4	ISC	<input type="checkbox"/>	<input checked="" type="checkbox"/>
12	Mode Matching Telescope between SEM and OMC (MMT5)	7.9	ISC	<input type="checkbox"/>	<input checked="" type="checkbox"/>
13	Photo Detectors (PDs)	7.8	ISC, Digital System	<input type="checkbox"/>	<input checked="" type="checkbox"/>

** Section in LCGT Design Document , Version 2

3. インターフェース / Interface of the **Input-Output Optics Subsystem**

各サブシステムの詳細設計を行うにあたり、決定しなければならない仕様、他のサブシステムで決めて欲しい仕様、もしくは合意されている仕様

* 実際に建設が始まったら決まっていないと困ること、建設完了までに決まっていないといけないこと。

この

欄は、人ではなく **subsystem** 名か↓

	事項 / Item	関連サブシステム / Related sub-system	要求値 / Value	合意済 / Confirmed
	MC2 output power	ISC	75W	ISC
	MC2 output spatial mode	ISC, Bandwidth	TEM00, M2<1.1 (waist size and location: TBD)	Not yet
	MC2 output polarization	ISC	S-pol, Is/Ip<0.01	Not yet
	MC2 output frequency noise	ISC	FN<4x10 ⁻⁸ Hz/rtHz at 100Hz	ISC
	MC2 output intensity noise	ISC	RIN<2x10 ⁻⁸ /rtHz at 100Hz	ISC
	MC2 output beam jitter	ISC	TBD	Not yet
	MC2 output phase modulation	ISC	PM m>(TBD) at f1=11.25MHz, AM g>(TBD) at f2=45MHz, PM m>(TBD) at f_WFS=(TBD).	Not yet
	MC2 output frequency tuning range	ISC	TBD	Not yet
	MC2 output intensity attenuation range	ISC	TBD	Not yet
	MC1 input power	Laser	150W	ISC
	MC1 input spatial mode	Laser	TEM00, M2<1.2 (waist size and location: TBD)	Not yet
*	Power consumption	坑内施設	TBD	not yet
*	Waist heat	坑内施設	TBD	not yet
*	Location and space	坑内施設	TBD	not yet
	Installation schedule	???	TBD	Not yet
	Budget allocation	???	TBD	Not yet
	Man power allocation	???	TBD	Not yet

↑ 当該サブシステムが決めないといけないことには * 印を付けること。

Infrastructure (vacuum chambers, beam tubes and opyical benches) for the Input-Output Optics Subsystem:

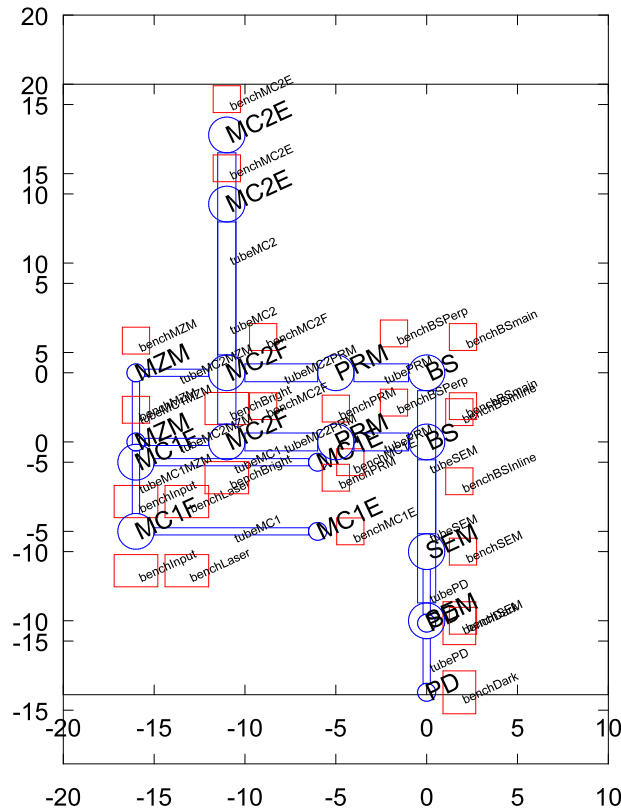

Locations of the centers and diameters of the vacuum chambers in the center area. The origin of the coordinate is at the center of beamsplitter chamber (BS).

#name	#description	#posx(m)	#posy(m)	#diameter(m)
BS	Beamsplitter chamber	0	0	2
PRM	Power recycling mirror chamber	-5	0	2
MC2F	Front chamber for second mode cleaner	-11	0	2
MC2E	End chamber for second mode cleaner	-11	13.3	2
MZM	Mach-Zehnder modulator chamber	-16	0	1
MC1F	Front chamber for first mode cleaner	-16	-5	2
MC1E	End chamber for first mode cleaner	-6	-5	1
SEM	Signal extraction mirror chamber	0	-10	2

0. サブシステムの現状 / Current status of the **Input-Output Optics Subsystem**

a) Conceptual design (サブシステムの定義) は確定しましたか? 確定 / 未定

- * 未定な部分がある場合、検討項目を簡単に記述して下さい。
- * Conceptual design の変更に伴い、予想される影響（検討事項）と関連 sub-group。

b) Alternative design は残っていますか? 残っている / いない

- * Alternative design の採用により生じると予想される影響（検討項目）と 関連 sub-group。

DC リードアウト導入への対応が保留中。

各光学素子の AR 面の残反射光の処理経路、MC に用いる鏡のウエッジ角の大きさが未検討。

Faraday アイソレータの真空内防振・水冷系のデザイン。水冷系の導入で万一破綻した場合、電気光学位相変調アイソレータのデザイン。

熱変形に対するモード補償の機能を MMT や MC1, MC2 に持たせるかどうか。

関連 sub-group: ISC (干渉計制御 sub-group)

c) 今年予算承認されたとした場合、年度内に決定すべき項目と関連 sub-group。

実験室内の配置、消費電力、廃熱量について坑内施設と打ち合わせる必要がある。

Subgroup Name	Interferometer Sensing And Control Subsystem
Subgroup Leader	Yoichi Aso The University of Tokyo

Doc version	Date	Description
Rev. A-0		

Interface Control Document for the ISC sub-system

Preface

This is a draft of the ICD for the LCGT-ISC sub-system.

Sub-System Definition

The role of the Interferometer Sensing and Control (ISC) sub-system is to keep the interferometer at its optimal operation point and extract the gravitational wave signal with low noise. This sub-system can be functionally broken into two parts: Sensing and Control.

Sensing

In order to control the interferometer, we have to know the state of the interferometer. Sensing part of this sub-system defines the methods to extract information about the state of the interferometer. We sort the degrees of freedom (DOFs) of an interferometer into three categories.

Length Sensing

The word "length" here means the distances between the mirrors. In addition to the geometric lengths, a change in the laser frequency also appears as an apparent change in the lengths for an interferometer. Therefore, the laser frequency is counted as a length here. There are 5 length DOFs to be controlled for a Dual-Recycled Fabry-Perot Michelson Interferometer (DRFPMI).

Name	Notation	Description
Michelson (MICH)	l-	Differential change of the Michelson arm lengths
Power Recycling Cavity Length (PRCL)	l+	Length of the power recycling cavity
Signal Recycling Cavity Length (SRCL)	ls	Length of the signal recycling cavity
Differential Arm Length (DARM)	L-	Differential change of the arm cavity lengths
Common Arm Length (CARM)	L+	Common change of the arm cavity lengths

Out of those DOFs, MICH, PRCL and SRCL are called "central part", "short DOFs" or "スモール系". DARM and CARM are called "arm DOFs", "long DOFs" or "ラージ系". CARM is often regarded as being equivalent to the laser frequency variation. DARM contains the gravitational wave signal, so it is the most important DOF.

Alignment Sensing

In order for a laser beam to properly resonate inside the interferometer, the beam and the mirrors of the interferometer must be aligned well. Alignment sensing is a mechanism to monitor errors in the alignment. A mirror has three rotational degrees of freedom, out of which only two (pitch and yaw) are important for an interferometer. For each of pitch and yaw, there are 6 alignment DOFs in an interferometer.

Name	Description
Common Stable (CS)	

Common Unstable (CU)	
Differential Stable (DS)	
Differential Unstable (DU)	
Power Recycling Mirror (PRM)	
Signal Recycling Mirror (SRM)	

CS, CU, DS, DU are the DOFs of the arms in the Sidles-Sigg basis [ref].

Auxiliary Signals

There are other signals which may have to be monitored (and possibly corrected for by feedbacks) during the operation of an interferometer.

Name	Description
Thermal lensing	Heat deposited on the mirrors by the laser beam can create a lensing effect. This lens mainly manifests itself as a mismatch of the spatial modes between the recombined beams at the dark port.
AS_I	If we use RF readout for the DARM, we may have to monitor the I-phase signal of the AS-port PD, which does not contain any GW signal but comes from junk light at the AS-port. AS-I could saturate the AS-PD in RF and reduce the dynamic range for the GW signal channel (AS-Q). If so, we can feedback the AS-I into the AS-PD current to cancel it.
SPOB	SPOB is Sideband Picked Off at Beam-splitter. The light picked off inside the PRC is demodulated at twice the frequency of the sidebands to serve as a measure of the sideband power in the PRC.

Control

Once the information about the state of the interferometer is obtained, we feedback the information to keep the interferometer at the optimal operation point. Feedback has to be strong enough to keep the error signals in linear regions so that up-conversion and other noises related to the non-linearity are well suppressed.

The control part consists of two successive components: Filtering and Actuation.

Filtering

Type	Description	Related Subsystems
Digital	Most of the ISC feedback filters will be implemented as digital filters.	Digital
Analog	Analog electronics are used where a wide feedback bandwidth is required. This will be the case mainly for the laser stabilization loops i.e. the frequency and intensity stabilization servos.	IFO support

Actuator

Actuators change the state of an interferometer.

Name	Description	Related Subsystems
Suspension actuators	These actuators move the mirrors. This is the realm of the suspension sub-system. ISC group will set requirements for the suspension actuators	Suspension
Laser actuators	Laser intensity and frequency has to be controllable with a high bandwidth.	IOO

Thermal	If necessary, the thermal deformations of the mirrors have to be compensated by some way, such as illuminating the mirrors with CO2 lasers.	IFO Support
---------	---	-------------

Requirements

The requirements for the ISC system ultimately come from the target sensitivity. Again the requirements for the ISC subsystem are divided into Sensing and Control.

Requirements for Sensing

DARM	The DARM sensing noise should be below the target sensitivity.
Other DOFs	The noises in the DOFs other than DARM affect the sensitivity through feedback. The sensing noises should be small enough to allow descent feedback gains for the auxiliary loops.

Requirements for Control

DARM	DARM actuator noise directly appears in the DARM noise spectrum. This has to be kept below the target sensitivity.
Other DOFs	Actuator noises in the DOFs other than DARM appear in the DARM signal through various couplings. The couplings have to be modeled and estimated to set the requirements for the actuator noises.

Interface with Other Sub-Systems

The ISC sub-system is realized by connecting hardware components provided by other sub-systems. So establishing good interface with the related sub-systems is imperative. Since the ISC requirements are set directly from the target sensitivity, ISC sets the requirements for other sub-systems in most cases.

Issues	Description	Numbers	Related Subsystems	Consensus
Laser Power			IOO	
Laser Frequency Noise			IOO	
Laser Frequency Control			IOO	
Laser Intensity Noise			IOO	
Laser Intensity Control			IOO	
Modulation			IOOI	
Input Mode Cleaner			IOO	
Output Mode Cleaner			IOO	
Seismic RMS			Suspension	
Mirror actuators			Suspension	

Mirror Loss			Mirror	
Mirror Transmittance			Mirror	
Mirror Coating			Mirror	
Folding RCs			IOO, Mirror, Suspension, Vacuum	
Vacuum Layout	Optical layout of the interferometer determines the layout of the vacuum tubes and chambers.		Vacuum	
Vacuum Pressure			Vacuum	
PD	Requirements for power handling, quantum efficiency, noise, bandwidth etc		IOO	
Analog Electronics Standards			IFO support	

Subgroup Name	Digital Subsystem
Subgroup Leader	Osamu Miyakawa ICRR U-Tokyo

Doc version	Date	Description
Rev. A-0	2009-06-2	Kick-off draft written in wiki format
Rev. A-1	2009-08-07	Converted to MS-Word format
Rev. A-2	2010-04-15	Fixed several parameters by the experience at CLIO digital system

Glossary

ADC	Analog to Digital Converter
DAC	Digital to Analog Converter
AA	Anti aliasing
AI	Anti imaging
UGF	unity gain frequency
IFO	interfoemter

1. Definition of subsystem

This system provides the functions which digitalize analog sensing signals extracted from interferometers, produce signals in computers for controlling the interferometers and data acquisitions, and re-produce analog signals to actuate the interferometer.

2. Task area

No.	Function	Description, equipments
1	Digital control system	Main system. PC, ADC/DAC, AA/AI filter, whitening/dewhitening filter, real time OS, control software, monitor software, data storage.
2	Detector tuning system	Adjusts interferometer parameters. Tuning software.
3	Detector diagnosis system	Interferometer self diagnosis. Diagnosis software.
4	Long term monitor	Monitor software, data storage
5	Auto lock / auto alignment sequencer	Real time lock code (fast), auto lock and alignment scripts (slow).
6	Detector operation system for GW observation	Operators, operation scheduling, auto lock scripts.
7	GW search data calibration	Real time calibration shown in the control room. Projectors, calibration signals, real time calibration software
8	Real time data analysis	Real time data analysis shown in the control room. Projectors, real time data analysis software

3. Required specifications

Item	Requirements	Comment
Sampling rate	>16kHz	
Dynamic range of input	>+/-15V	Half on differential
Dynamic range of output	>+/-10V	Half on differential
ADC noise	<3uV/rHz	
DAC noise	<3uV/rHz	
time delay	<100usec	To realize 300Hz UGF
Input channel numbers	>1024ch	(16kHz:>128ch, 2kHz:>256ch, 64Hz>512ch)
Output channel numbers	>256ch	for suspensions, PZTs
Stored channel	16kHz:>64ch, 2kHz:>256ch, 64Hz>512ch	

4. Interface between systems

	Item	Related sub-system	Requirements	Agreement
*	Sampling rate	Data acquisition, Data analysis, IFO control	16384Hz(sampeled at 65536Hz and decimated to 16384Hz) option:up to 65536Hz for limited number of channels	not yet
	Number of channels	Data acquisition, Data analysis, IFO control	16kHz:64ch, 2kHz:256ch, 64Hz:512ch 16Hz:2048 epics channels (see channel list)	not yet
*	Data bit resolution	Data acquisition	24bit = 4 Byte integer	not yet
	Data transfer rate	Data acquisition	4MB/sec for 16kHz, 2MB/sec for 2kHz, 128kB/sec for 64Hz 128kB/sec for 16Hz	not yet
	Saved parameters (using conlog)	Data analysis, IFO control	See parameter list	not yet
*	ADC dynamic range	IFO control	Full differential +/-10V = effective range +/-20V	not yet
*	DAC dynamic range	IFO control	Full differential +/-5V = effective range +/-10V	not yet
*	through delay	IFO control	80usec	not yet
*	ADC noise level	IFO control	2uV/rHz	not yet
*	DAC noise level	IFO control	1.5uV/rHz	not yet
*	AA filter noise level	IFO control	0.1u V/rHz	not yet
*	AI filter noise level	IFO control	0.1u V/rHz	not yet
*	whitening filter noise level	IFO control	1n V/rHz	not yet
*	dewhitening filter noise level	IFO control	1n V/rHz	not yet
*	whitening filter input impedance	IFO control	TBD	not yet
*	dewhitening filter output impedance	IFO control	TBD	not yet
	Connector shape	IFO control	D-SUB9 @ AA and AI BNC or SMA (or LEMO) for single 2pin LEMO for differential @ whitening / dewhitening and binary	not yet

			switch	
*	Power consumption	Infrastructure	TBD	not yet
*	Waste heat and cooling	Infrastructure	TBD	not yet
	Network capability	Infrastructure	10Gbps ethernet	not yet
*	Optical fiber cable capability for real time PC, clock timing system	Infrastructure	TBD	not yet
	GPS antenna	Infrastructure, Data acquisition	TBD	
	Location and space	Infrastructure, Data acquisition, IFO control	3 racks at center room, 1 rack at X end room, 1 rack at Y end room for control system 10 racks at data center	not yet
*	Remote control switch	Vacuum, Infrastructure	TTL(0V-5V)	not yet
	Wireless LAN (digital system on laptop PC)	Infrastructure	IEEE802.11n(300Mbps)	not yet

↑ Mark * on items which this subsystem needs to define.

5. Other related subsystems

No.	Function	Related sub-system	Description, equipments
1	CCD monitor	IFO support	
2	Inter lock	Infrastructure, IFO support	
3	Entrance monitor system	Infrastructure	
4	Real time monitors at control room	Infrastructure, IFO support, Data acquisition, Data analysis	
5	Control PCs at control room	Infrastructure, Data analysis	Linux, 2-3 heads/PC, 10 PCs at least

6. Channel list

a. 16kHz (total 64ch)

Part	Channel point	Channel number	Description
Laser	Output laser power[W]	1	
	IFO Input laser power[W]	1	
MC	REFL	1	
	MC length feedback	1	
	MC frequency feedback	1	
LSC	I&Q dor DARM, CARM, MICH, PRC, SRC, etc.	10	
	error, feedback	10	
SUS	length * 10 suspensions	10	

b. 2kHz (total 256ch)

Part	Channel point	Channel number	Description
ASC	WFS	5xpitch, yaw=50	
	Oplev	10xpitch, yaw=100	

c. 64Hz Long term monitor (total 512ch)

Part	Channel point	Channel number	Description
Temperature[deg]	room	10	center, end, arm

	table	10	laser, REFL, AS, pickoff, end
	suspensions	50	Low temperature
	mirrors	50	Low temperature
Humidity[%]	rooms	10	center, end, arm
Dust	rooms	10	center, end, arm
Laser	crystal temperature[degree] and etc.	10	
	Master laser power[W]	2	
	Output laser power[W]	2	
	IFO Input laser power[W]	2	
Seismic	Room, outside, 3-axis	30	
Sound	Room, outside, table		

7. Saved parameter list

Gain, switch, offset, filter bank, filter on/off, matrix components and all other parameters on Epics channel

Subgroup Name	Interferometer Support Subsystem
Subgroup Leader	Shinji Miyoki ICRR, The University of Tokyo

Doc version	Date	Description
Rev. A-0		

．'''干渉計サポート'''

* (1) 散乱光

おもに、クライオスタットに侵入する 300K 領域からの輻射の散乱光に起因する熱流量対策について設計する。

ただし、CLIO において、内山君、都丸君による、理論的見積もりの修正、その実験的検証、及び、対策案の実験的結果があるので、それを基本に設計する。

* (2) 60Hz

鉦山内という岩板環境におけるグラウンドの取り回しと、ハム(60Hz)の低減(撲滅)に関して指針を定める。

* (3) 熱レンズ

おもに、熔融石英製の BS における熱レンズ効果についてその見積もり、シミュレーション、対策を考える。ただし、すでに LIGO により、別レーザーによる光学素子の二次元加熱法が進行しているので、その方法を基本に考える。

その後、LIGO の山本さんが、「高品質な熔融石英が得られれば、BS の熱レンズは考えなくていいのでは」という提案を頂き、その線で行くことにしました。

* (4) クリーン環境

振動源にならないクリーン環境の設置を考える。

Subgroup Name	Scattered Light Control
Subgroup Leader	Shinji Miyoki ICRR, UT

Doc version	Date	Description
Rev. A-0	2009-05-31	Kick-off draft

Glossary

SLC	Scattered Light Control
DLC	Diamond Liked Carbon (coating)
NIP	Nickel Phosphorus (coating)

1. 各サブシステムの簡単な定義 / Concise definition of Scattered Light Control

LCGT 建設完了までに各サブグループが責任を持って提供すべき機能と、それを実現するための基本的対策。

No.	機能 / Function	基本的対策 / Policy
1	SLC for Main 3km Duct	- Diamond Liked Carbon (DLC) or NIP Coated Baffles
2	SLC for Radiation Shield Duct	Diamond Liked Carbon (DLC) or NIP Coated Baffles Radiation Protector coated by DLC or NIP around Mirrors in the inner shield.
3	SLC for Main IFO Optics	Proper wedge angle Low reflection low scattered loss AR coating Optical dumping set for the high intensity AR reflected light Optical dumping set for the high angle scattered light
4	SLC for Input Output Optics	HR mirrors are desirable Back side should be polished and AR coated Proper wedge Optical dumping set for the transmitted light
5	SLC for Vacuum Windows	Proper edge Double AR coated Optical dumping set for the high intensity AR reflected light
6	SLC for Photo Detectors	Housed in NIP coated box Optical dumping set for the high intensity AR reflected light Optical dumping set for the reflected light fro PDs
7	SLC for non-Linear Optics	Optical dumping set for the high intensity AR reflected light Brewster angle cutting
8	SLC for Beam Axes	Iris NIP coated meshed metal tube beam guide

2. 要求仕様 / Required specifications Scattered Light Control

1で示した機能に対する要求仕様が記述されている LCGT design document version 2 での section 番号、関連 sub-system、Design document version 2 からの変更の有無と可能性。

No.	機能 / Function	Described section (**)	Required value	modified	to be modified
1	SLC for Main 3km Duct	14.2	Less than 1/10 of the targeted Sensitivity (2×10^{-21} is designed)	<input type="checkbox"/>	<input checked="" type="checkbox"/>
2	SLC for Radiation Shield Duct	New	Less than 1/30 of the designed heat for one mirror (~ 300mW) Practical baffles design is proven in CLIK (Tomaru) Practical mirror shield is proven in CLIO (Uchiyama)	<input type="checkbox"/>	<input checked="" type="checkbox"/>
3	SLC for Main IFO Optics	New	Damp 10ppm loss from one mirror	<input type="checkbox"/>	<input checked="" type="checkbox"/>
4	SLC for Input Output Optics	New	Not fixed	<input type="checkbox"/>	<input checked="" type="checkbox"/>
5	SLC for Vacuum Windows	New	Not fixed	<input type="checkbox"/>	<input checked="" type="checkbox"/>
6	SLC for Photo Detectors	New	Not fixed	<input type="checkbox"/>	<input checked="" type="checkbox"/>
7	SLC for non-Linear Optics	New	Not fixed	<input type="checkbox"/>	<input checked="" type="checkbox"/>
8	SLC for Beam Axes	New	Not fixed	<input type="checkbox"/>	<input checked="" type="checkbox"/>

** Section in LCGT Design Document

3. インターフェース / Interface of the Scattered Light Control

各サブシステムの詳細設計を行うにあたり、決定しなければならない仕様、他のサブシステムで決めて欲しい仕様、もしくは合意されている仕様

* 実際に建設が始まったら決まっていなくて困ること、建設完了までに決まっていなくていけないこと。

	事項 / Item	関連サブシステム / Related sub-system	要求値 / Value	合意済 / Confirmed
	SLC for Main 3km Duct	Vacuum SPI	Outgas level	By Vacuum for DLC, not NIP
*	SLC for Radiation Shield Duct	Vacuum Cryostat Refrigerator	Refrigerator power to evacuate the heat load from 300K area.	By Cryostat system
	SLC for Main IFO Optics	Vacuum ISC Mirror Coating	Position Scattered light level, angle	Not yet
*	SLC for Input Output Optics	Vacuum	Housed in vacuum?	Not yet
*	SLC for Vacuum Windows			not yet
*	SLC for Photo Detectors	Clean Environment Sound Environment	Clean air introduction Box material	not yet
*	SLC for non-Linear Optics	Input optics	Scattered light level	not yet
*	SLC for Beam Axes	Input Optics Design	Layout	not yet

↑ 当該サブシステムが決めないといけないことには * 印を付けること。

Subgroup Name	60Hz Control
Subgroup Leader	Shinji Miyoki ICRR, UT

Doc version	Date	Description
Rev. A-0	2009-05-31	Kick-off draft

1. 各サブシステムの簡単な定義 / Concise definition of the 60Hz Control

LCGT建設完了までに各サブグループが責任を持って提供すべき機能と、それを実現するための基本的対策。

No.	機能 / Function	基本的対策 / Policy
1	Primary Power Source	Grounding AC line purity enhancement
2	Secondary Power Source	Noise cut trance introduction AC-AC or AC-DC? conversion
3	Grounding Control for Instruments	Common ground bar Electro conductive concrete introduction
4	Signal Cross Talk control	Categorization (RF, AM, AC, DC, Network) Electrical shield introduction Separation between categories
5	Special Treatment for Specific Instruments	Battery with the auto charge system
6	Signal Transfer	AM : Differential amp, Isolation amp, Optical coupler RF : Ground cutting using transfer

2. 要求仕様 / Required specifications of the 60Hz Control

1で示した機能に対する要求仕様が記述されている LCGT design document version 2 での section 番号、関連 sub-system、Design document version 2 からの変更の有無と可能性。

No.	機能 / Function	Described section (**)	Required value	modified	to be modified
1	Primary power source	New	Obey the manufacturer level	<input type="checkbox"/>	<input checked="" type="checkbox"/>
2	Secondary power source	New	TBD	<input type="checkbox"/>	<input checked="" type="checkbox"/>
3	Grounding control for instruments	New	Grounding Copper Bar Introduction	<input type="checkbox"/>	<input checked="" type="checkbox"/>
4	Signal cross talk control	New	TBD	<input type="checkbox"/>	<input checked="" type="checkbox"/>
5	Special treatment for specific instruments	New	TBD	<input type="checkbox"/>	<input checked="" type="checkbox"/>
6	Signal transfer	New	TBD	<input type="checkbox"/>	<input checked="" type="checkbox"/>

** Section in LCGT Design Document

3. インターフェース / Interface of the 60Hz Control

各サブシステムの詳細設計を行うにあたり、決定しなければならない仕様、他のサブシステムで決めて欲しい仕様、もしくは合意されている仕様

* 実際に建設が始まったら決まっていないと困ること、建設完了までに決まっていないといけないこと。

	事項 / Item	関連サブシステム / Related sub-system	要求値 / Value	合意済 / Confirmed
1	Primary power source and grounding	Facility	TBD	Not yet
2	Secondary power source	Facility	TBD	Not yet
3	Grounding control for instruments	Facility	TBD	Not yet
4	Signal cross talk control	Facility	TBD	Not yet
5	Special treatment for specific instruments	Data taking Data analysis Facility	TBD	not yet
6	Signal transfer	Data taking Data analysis Facility	TBD	not yet

↑ 当該サブシステムが決めないといけないことには * 印を付けること。

Subgroup Name	Thermal Lensing Control
Subgroup Leader	Shinji Miyoki ICRR, UT

Doc version	Date	Description
Rev. A-0	2009-05-31	Kick-off draft

1. 各サブシステムの簡単な定義 / Concise definition of the Thermal Lensing Control

LCGT 建設完了までに各サブグループが責任を持って提供すべき機能と、それを実現するための基本的対策。

No.	機能 / Function	基本的対策 / Policy
1	Beam Splitter	Prepare super low absorption loss SiO ₂ (< 0.1ppm/cm, possibly 0.02 ppm/cm), which will be prepared in Ad-LIGO, then minimize thermal lensing problem For the worst case, the thermal compensation method used in LIGO will be introduced.
2	Non-Linear Optics	Apply beam profile design accounting for the thermal lensing. Wider beam introduction into the EOMs and Faraday Isolators.
3	Mode Cleaner	Design to set the wider beam size on the mirrors
4	Input Test Mass (option)	Prepare super low absorption loss SiO ₂ (< 0.1ppm/cm) which will be prepared in Ad-LIGO, then minimize thermal lensing problem

2. 要求仕様 / Required specifications the Thermal Lensing Control

1で示した機能に対する要求仕様が記述されている LCGT design document version 2 での section 番号、関連 sub-system、Design document version 2 からの変更の有無と可能性。

No.	機能 / Function	Described section (**)	Required value	modified	to be modified
1	Beam Splitter	New	Absorption loss < 0.1ppm/cm for SiO2 Coating Absorption loss < 0.5 ppm?	<input type="checkbox"/>	<input checked="" type="checkbox"/>
2	Non-Linear Optics	7.7 7.9	TBD	<input type="checkbox"/>	<input checked="" type="checkbox"/>
3	Mode Cleaner	7.2	Absorption loss : no problem Coating Absorption loss < 0.5 ppm?	<input type="checkbox"/>	<input checked="" type="checkbox"/>
4	Input Test Mass (option)	New	Absorption loss < 0.1ppm/cm for SiO2	<input type="checkbox"/>	<input checked="" type="checkbox"/>

** Section in LCGT Design Document

3. インターフェース / Interface of the Thermal Lensing Control

各サブシステムの詳細設計を行うにあたり、決定しなければならない仕様、他のサブシステムで決めて欲しい仕様、もしくは合意されている仕様

* 実際に建設が始まったら決まっていないと困ること、建設完了までに決まっていないといけないこと。

	事項 / Item	関連サブシステム / Related sub-system	要求値 / Value	合意済 / Confirmed
*	Beam Splitter			Not yet
*	Non-Linear Optics	Input Optical System Design	Adjustable optical layout	Not yet
*	Mode Cleaner	Input Optical System Design	Adjustable optical layout	Not yet
*	Input Test Mass (option)	Mirror	Absorption loss < 0.1ppm/cm for SiO ₂	Not yet

↑ 当該サブシステムが決めないといけないことには * 印を付けること。

Subgroup Name	Clean Environment
Subgroup Leader	Shinji Miyoki ICRR, UT

Doc version	Date	Description
Rev. A-0	2009-05-31	Kick-off draft

1. 各サブシステムの簡単な定義 / Concise definition of the Clean Environment Control

LCGT建設完了までに各サブグループが責任を持って提供すべき機能と、それを実現するための基本対策。

No.	機能 / Function	基本対策 / Policy
1	Primary Clean Air (C class)	Production at out of the tunnel Class 10000 Transfer the air to secondary clean air production
2	Secondary Clean Air (B class)	Production at the access tunnel area. Class 1000 For a part of 3km tunnel near cryostat, Center, End stations, for cleaning before mechanics and electronics installing A part of the air directly introduced to (A, S class) air production instruments
3	Special Clean Air (A class)	Optics assembly area (Working bench, Cryostat area) Class 100
4	Super Clean Air (S Class)	Mirror assembly area Class <100

2. 要求仕様 / Required specifications for the Clean Environment Control

1で示した機能に対する要求仕様が記述されている LCGT design document version 2 での section 番号、関連 sub-system、Design document version 2 からの変更の有無と可能性。

No.	機能 / Function	Described section (**)	Required value	modified	to be modified
1	Primary Clean Air (C class)	New	Class 10000	<input type="checkbox"/>	<input checked="" type="checkbox"/>
2	Secondary Clean Air (B class)	New	Class 1000	<input type="checkbox"/>	<input checked="" type="checkbox"/>
3	Special Clean Air (A class)	New	Class 100	<input type="checkbox"/>	<input checked="" type="checkbox"/>
4	Super Clean Air (S Class)	New	< Class 100	<input type="checkbox"/>	<input checked="" type="checkbox"/>

** Section in LCGT Design Document

3. インターフェース / Interface of the Clean Environment Control

各サブシステムの詳細設計を行うにあたり、決定しなければならない仕様、他のサブシステムで決めて欲しい仕様、もしくは合意されている仕様

* 実際に建設が始まったら決まっていないと困ること、建設完了までに決まっていないといけないこと。

	事項 / Item	関連サブシステム / Related sub-system	要求値 / Value	合意済 / Confirmed
*	Primary Clean Air (C class)	Facility	Space Cost	Not yet
*	Secondary Clean Air (B class)	Facility	Space Cost Tunnel design Meshed floor	Not yet
*	Special Clean Air (A class)	Facility	Cost Meshed floor	Not yet
*	Super Clean Air (S Class)	Facility	Cost Meshed floor	Not yet

↑ 当該サブシステムが決まらないといけないことには * 印を付けること。

Interface Control Document of LCGT

Subgroup Name	Vibration Isolation System
Subgroup Leader	Ryutaro Takahashi National Astronomical Observatory of Japan
Sub-leader	Takashi Uchiyama Institute for Cosmic Ray Research
Sub-leader	Shinji Miyoki Institute for Cosmic Ray Research

Doc version	Date	Description
Rev. A-2	2010-04-15	Revised draft

APPROVAL AUTHORITIES

Concise definition of vibration isolation system

System requirement

Displacement of the test mass mirrors must be less than $6 \times 10^{-18} \text{m/Hz}^{1/2}$ at 5Hz where the seismic noise and the radiation pressure noise are crossed. RMS motion must be less than 0.1 μm . The test mass mirrors are cooled to 20K through heat links.

SAS

Core optics are suspended by SASs. Two kinds of SASs are used in LCGT. Type-A SAS consists of an IP, three stage MGAS filters and a cryogenic mirror suspension. Type-B SAS consists of an IP, two stage MGAS filters and a mirror suspension. Type-A SASs are used for FM1, FM2, EM1 and EM2. Type-B SASs are used for BS, PRM, SEM, MC2F and MC2E.

Stack

Three stage stacks are used for BS, PRM, SEM, MC2F, MC2E, MC1F, MC1E, MMT and PD. Rubbers are enclosed by welded bellows. Some optics are placed on the stage 0.

Glossary

SAS	Seismic Attenuation System
IP	Inverted Pendulum
MGAS	Monolithic Geometric Anti Spring
PF	Platform
IM	Intermediate Mass
MB	Magnet Box
TM	Test Mass
RM	Recoil Mass
ACC	Accelerometer
LVDT	Linear Variable Differential Transformer
FM	Front Mirror
EM	End Mirror
BS	Beam Splitter
PRM	Power Recycling Mirror
SEM	Signal Extraction Mirror
MC	Mode Cleaner
MMT	Mode Matching Telescope
PD	Photo Detector

Figure: Schematic drawing of the vibration isolation system.

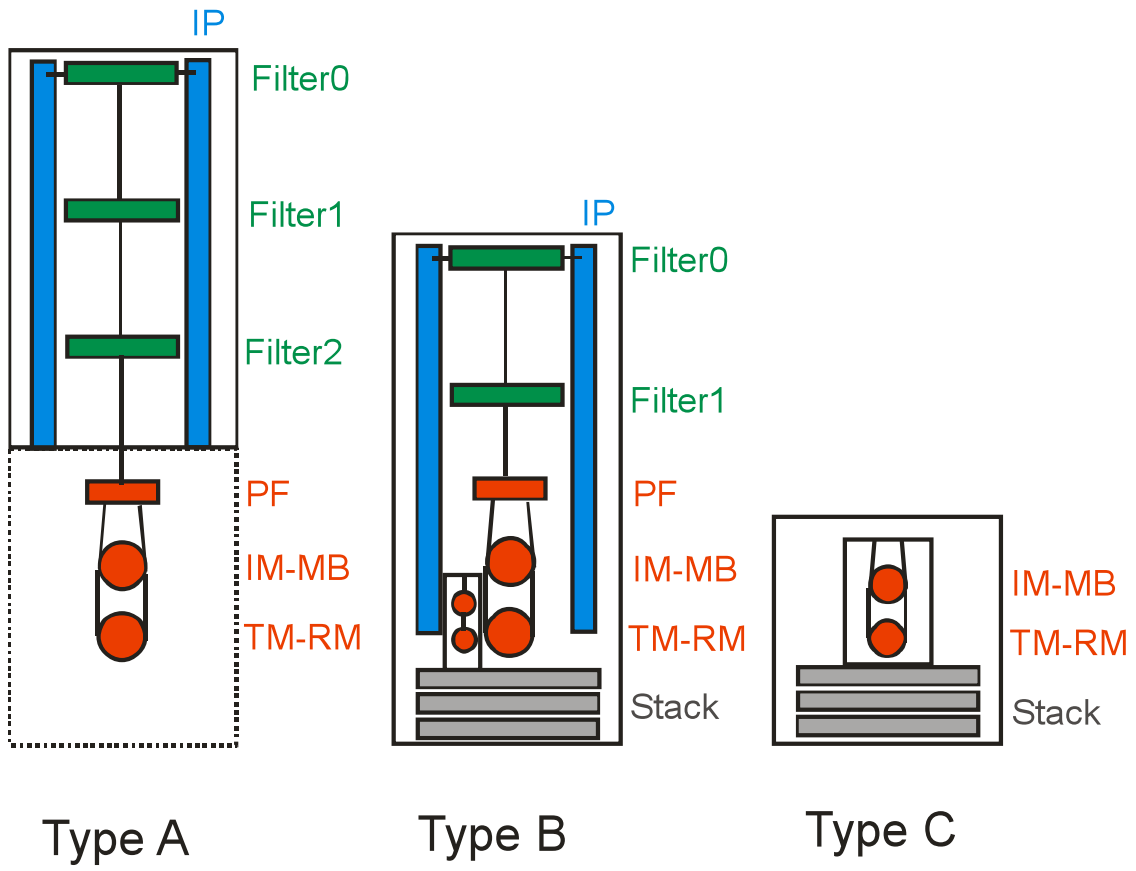

Table: Specification of the vibration isolation system

		#	Electric	Interface
Type-A SAS		4		Vacuum
Inverted pendulum (IP)				
Leg	30mHz	3		
ACC	$<10^{-10}\text{m/Hz}^{1/2}@1\text{Hz}$	3	DC15V	Control
LVDT	$<10^{-8}\text{m/Hz}^{1/2}@1\text{Hz}$	3	DC15V	Control
Actuator	10mm/V	3	DC15V	Control
Moter slider	H	3	DC12V	Control
Filter0	120kg			
MGAS	H: 0.55Hz, V: 0.2Hz	1		
H-LVDT	$<10^{-8}\text{m/Hz}^{1/2}@1\text{Hz}$	1	DC15V	Control
Filter1	120kg			
MGAS	H: 0.55Hz, V: 0.2Hz	1		
H-LVDT	$<10^{-8}\text{m/Hz}^{1/2}@1\text{Hz}$	1	DC15V	Control
Filter2	120kg			
MGAS	H: 0.5Hz, V: 0.2Hz	1		
H-LVDT	$<10^{-8}\text{m/Hz}^{1/2}@1\text{Hz}$	1	DC15V	Control
Piezo-moter	Yaw	1	?	Control
Platform (PF)	120kg, 14K			
mini-GAS	V: 0.7Hz	4		
Piezo-moter	V	4	?	Control
Moter slider	H	2	DC12V	Control
Position Sensor	$<10^{-9}\text{m/Hz}^{1/2}@1\text{Hz}$	8	DC15V	Control
Actuator	1mm/V	8	DC15V	Control
Heat link	H: 14mHz, V: 8mHz, 1W			Cryostat
Intermediate mass (IM)	60kg, 15K			
Heat link	1W			Cryostat
Magnet block (MB)	60kg, 14K			
Position Sensor	$<10^{-9}\text{m/Hz}^{1/2}@1\text{Hz}$	6	DC15V	Control
Actuator	0.1mm/V	6	DC15V	Control
Test mass (TM)	30kg, 20K			Optics
Recoil mass (RM)	30kg, 15K			
Actuator	0.01mm/V	4	DC15V	Control

		#	Electric	Interface
Type-B SAS		5		Vacuum
Inverted pendulum (IP)				
Leg	30mHz	3		
ACC	$<10^{-10}\text{m}/\text{Hz}^{1/2}@1\text{Hz}$	3	DC15V	Control
LVDT	$<10^{-8}\text{m}/\text{Hz}^{1/2}@1\text{Hz}$	3	DC15V	Control
Actuator	10mm/V	3	DC15V	Control
Moter slider	H	3	DC12V	Control
Filter0	60kg			
MGAS	H: 0.55Hz, V: 0.2Hz	1		
H-LVDT	$<10^{-8}\text{m}/\text{Hz}^{1/2}@1\text{Hz}$	1	DC15V	Control
Filter1	60kg			
MGAS	H: 0.55Hz, V: 0.2Hz	1		
H-LVDT	$<10^{-8}\text{m}/\text{Hz}^{1/2}@1\text{Hz}$	1	DC15V	Control
Piezo-moter	Yaw	1	?	Control
Platform (PF)	60kg			
mini-GAS	V: 2Hz	4		
Piezo-moter	V	4	?	Control
Moter slider	H	2	DC12V	Control
Position Sensor	$<10^{-9}\text{m}/\text{Hz}^{1/2}@1\text{Hz}$	8	DC15V	Control
Actuator	1mm/V	8	DC15V	Control
Intermediate mass (IM)	30kg			
Magnet block (MB)	30kg			
Position Sensor	$<10^{-9}\text{m}/\text{Hz}^{1/2}@1\text{Hz}$	6	DC15V	Control
Actuator	0.1mm/V	6	DC15V	Control
Test mass (TM)	16kg			Optics
Recoil mass (RM)	16kg			
Actuator	0.1mm/V	4	DC15V	Control

		#	Electric	Interface
Stack	H: 2Hz	9		Vacuum
Stage 0				
Breadboard	200kg	1		
Bellows		3		
Rubber		3		
Stage 1				
Block	200kg	3		
Bellows		9		
Rubber		9		
Stage 2				
Block	200kg	3		
Bellows		9		
Rubber		9		

General requirement		Band	Interface
PSD displacement	$6 \times 10^{-18} \text{m/Hz}^{1/2}$	5Hz	
RMS displacement	0.1 μm	0.1–4Hz	Control
RMS velocity	0.1 $\mu\text{m/s}$	DC–4Hz	Control
RMS pitch	10nrad	1–10Hz	Control
RMS pitch	1 μrad	0.1–1Hz	Control
RMS yaw	10nrad	1–10HZ	Control
RMS yaw	1 μrad	0.1–1Hz	Control

Geometry of Payload for LCGT (Type-A)

		M [kg]	Ix [m ² kg]	Iy [m ² kg]	Iz [m ² kg]
PF	Al	120	3.80	3.80	7.20
IM	Al	60	1.00	0.61	1.30
MB	SUS	60	2.20	1.60	3.50
TM	Sapphire	30	0.23	0.17	0.17
RM	Al	30	0.68	0.55	0.55

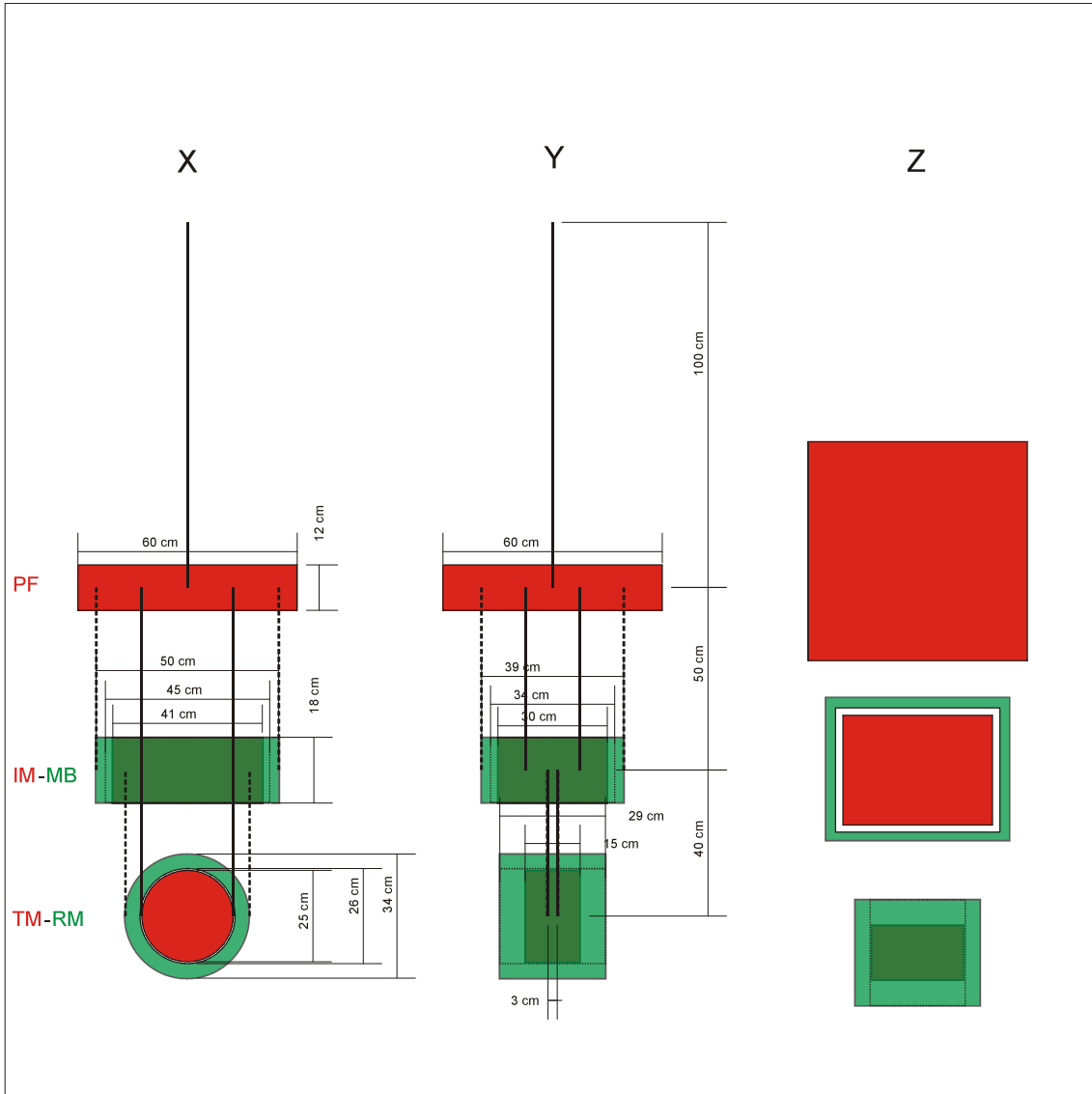

Geometry of Payload for LCGT (Type-B)

		M [kg]	Ix [m ² kg]	Iy [m ² kg]	Iz [m ² kg]
PF	Al	60	1.20	1.20	2.30
IM	Al	30	0.32	0.19	0.42
MB	SUS	30	0.76	0.53	1.20
TM	Silica	16	0.13	0.09	0.09
RM	Al	16	0.32	0.27	0.27

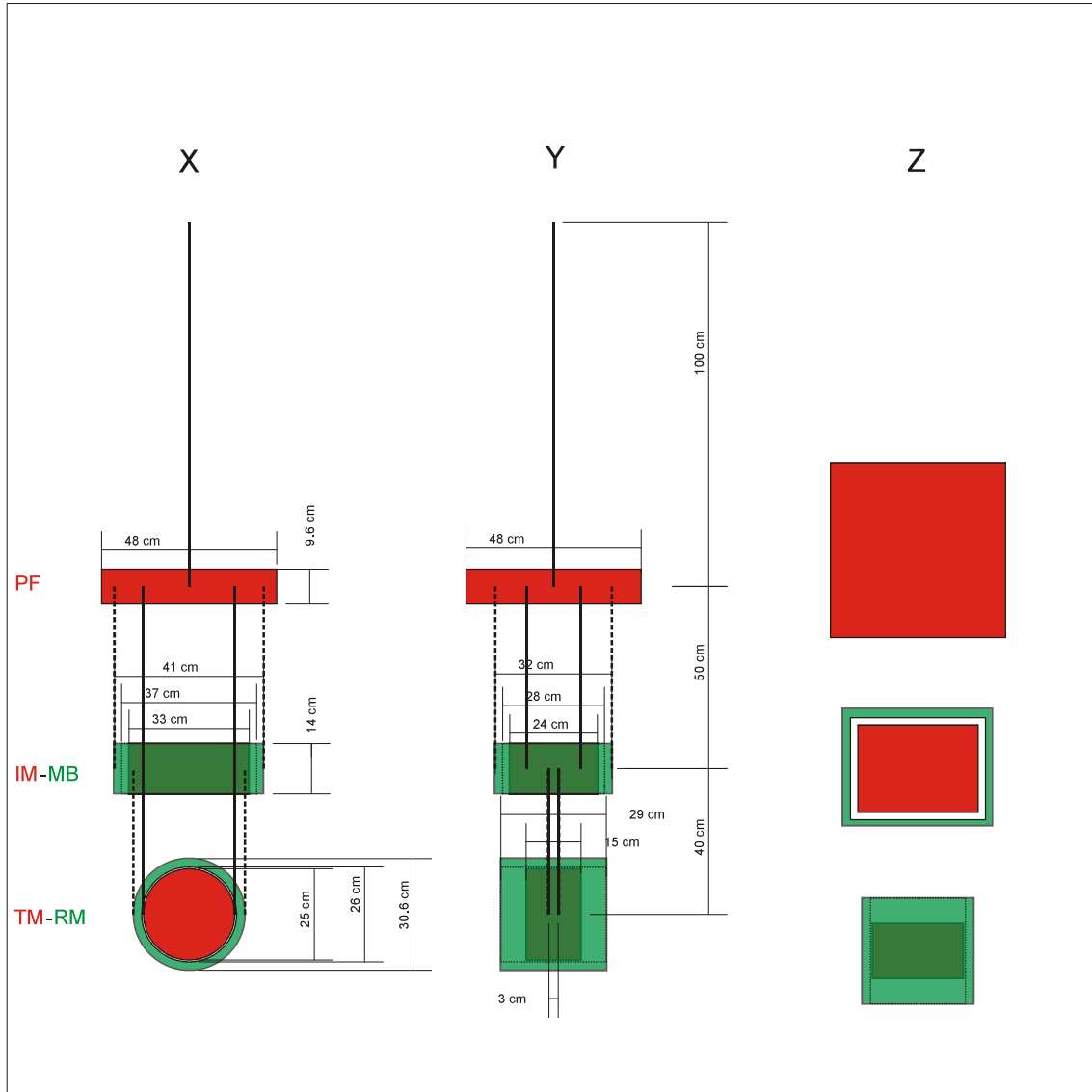

Subgroup Name	Cryocooler Subsystem
Subgroup Leader	Toshikazu Suzuki High Energy Accelerator Research Organization
Subleader	Tomiyoshi Haruyama High Energy Accelerator Research Organization

Doc version	Date	Description
Rev. 0	2009-05-24	Kick-off draft

略語集 / Acronyms and Abbreviations

PTC	Pulse Tube Cryocooler
VRS	Vibration Reduction Stage

Cryocooler System

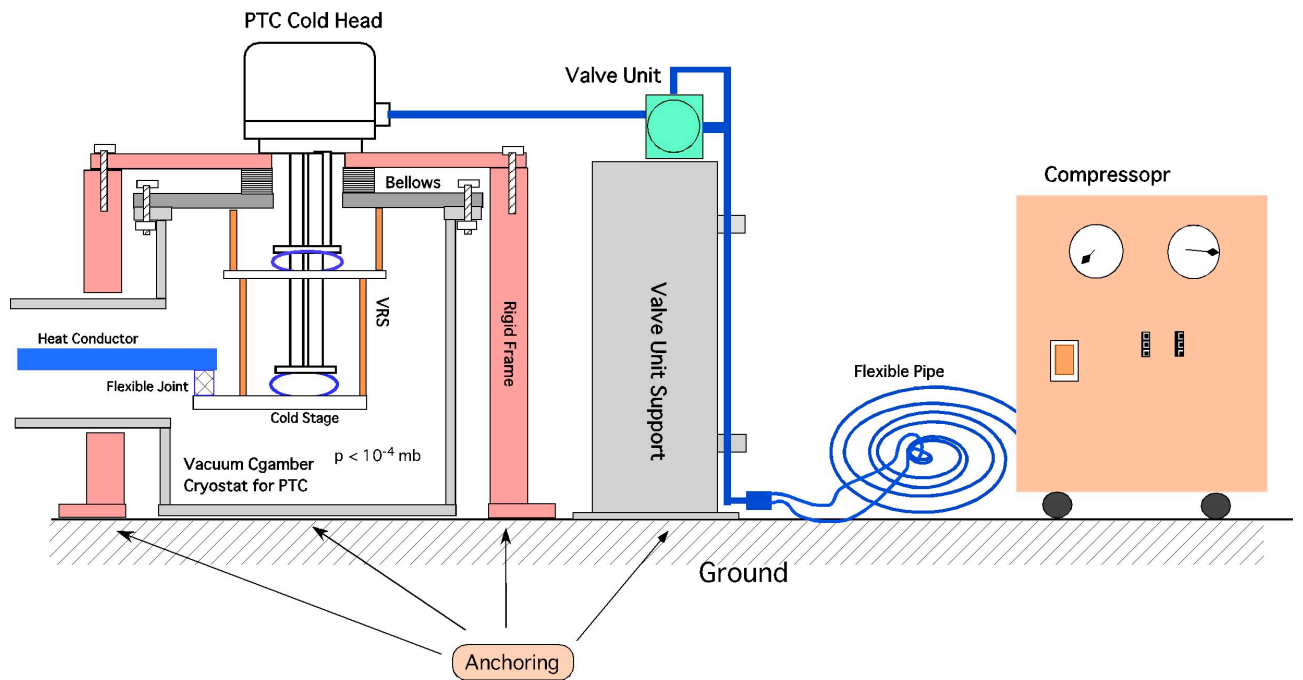

1. 各サブシステムの簡単な定義 / Concise definition of Cryocooler System

LCGT 建設完了までに各サブグループが責任を持って提供すべき機能と、それを実現するためのハードウェア、ソフトウェア。

No.	機能 / Function	ハードウェア・ソフトウェア / Hardware, software
1	Cooling Unit	Pulse Tube Cryocooler with remote valve unit.
2	Anchoring Structure for Cold Head	Rigid frame for PTC cold head and vacuum chamber with bellows connection.
3	Low vibration cold stage	VRS consist of rigid support and flexible heat link to PTC cold stage
4	Anchoring Structure for valve unit	Rigid support for valve unit and rigid piping to the PTC cold head.
5	Pressure supply unit	Helium gas compressor with low acoustic noise. Flexible pipe connection to the valve unit.
6	Heat path to Cryostat	Heat conductor, thermal insulator and mechanical support. Flexible connectur for heat conductor.
7	Floor for mechanical anchoring	Stable and rigid ground.
8		

2. 要求仕様 / Required specifications for Cryocooler System

1で示した機能に対する要求仕様が記述されている LCGT design document version 2 での section 番号、関連 sub-system、Design document version 2 からの変更の有無と可能性。

No.	機能 / Function	Described section (**)	Related sub-systems	変更有り modified	変更の可能性 有り to be modified
1	Cooling Unit	11.2.1		<input type="checkbox"/>	<input checked="" type="checkbox"/>
2	Anchoring Structure for Cold Head	11.2.2		<input type="checkbox"/>	<input checked="" type="checkbox"/>
3	Low vibration cold stage	11.2.2		<input type="checkbox"/>	<input checked="" type="checkbox"/>
4	Anchoring Structure for valve unit	11.2.2		<input type="checkbox"/>	<input checked="" type="checkbox"/>
5	Pressure supply unit			<input type="checkbox"/>	<input checked="" type="checkbox"/>
6	Heat path to Cryostat	11.1 、 11.2.3、10.2		<input type="checkbox"/>	<input checked="" type="checkbox"/>
7	Floor for mechanical anchoring	11.2.2、19.3		<input type="checkbox"/>	<input checked="" type="checkbox"/>
8				<input type="checkbox"/>	<input type="checkbox"/>
				<input type="checkbox"/>	<input type="checkbox"/>

** Section in LCGT Design Document , Version 2

3. インターフェース / Interface of the Cryocooler System

各サブシステムの詳細設計を行うにあたり、決定しなければならない仕様、他のサブシステムで決めて欲しい仕様、もしくは合意されている仕様

* 実際に建設が始まったら決まっていないと困ること、建設完了までに決まっていないといけないこと。

	事項 / Item	関連サブシステム / Related sub-system	要求値 / Value	合意済 / Confirmed
	Cooling power at Cryostat connection	Cryostat, Suspension design		
	Vibration at Cryostat connection	Cryostat, Suspension design		
	Cooling water. Available flow rate, temperature.	Construction, Facilities		
	Power consumption of compressor	Construction, Facilities		
	Tolerance of vibration and acoustic noise environment.	Vibration isolator, other equipments		
	Location of cryostat. Configuration of cryocooler systems.	Optics, Construction, Facilities		
	Working space around cryostat.	Construction, Facilities		
	Installation schedule			
	Budget allocation			
	Man power allocation			

↑ 当該サブシステムが決めないといけないことには * 印を付けること。

Subgroup Name	Vacuum subsystem
Subgroup Leader	Yoshio Saito KEK-High Energy Accelerator Research Organization
Sub-leader	Ryutaro Takahashi National Astronomical Observatory of Japan

Doc version	Date	Description
Rev. A-0	2009-05-28	Kick-off draft

Concise definition of vacuum system

Beam tube

Two 3-km vacuum tubes are kept in 2×10^{-7} Pa of vacuum pressure so as to reduce scattering-effects due to residual gas molecules.

The stainless-steel material SUS304L or SUS316 is among the most available for use as long tubes of 3km long and 1m in diameter. Since baking over the entire system of long tubes is not easy, further requiring a large electric power supply, some kinds of surface processing methods for reducing outgas are necessary to be applied to the unit tubes before installation in the tunnel. The ECB method is practically advantageous for large-chamber applications, because it can be performed without any large liquid reservoir or large coating system.

Baffles are characteristic of the beam tubes. The scattered light from the surface of tubes is blocked by the baffle. The surface of the baffle is treated with DLC coatings.

Chamber

Four kinds of vacuum chambers are used in LCGT. The size of each type is dependent in the structure of vibration isolation system for mirrors which are placed in the chamber; SAS + cryogenic mirror suspension in Type A chamber, SAS + mirror suspension in Type B chamber, and stack + mirror suspension in Type C chamber. The stainless-steel material SUS304 is among the most available for use as also large chambers of 1-2m in diameter.

Thirteen chambers are connected by the beam tubes with gate valves of DN1000 or DN400 each other.

Pumping system

From atmospheric pressure to several tens of Pa, a mechanical pump is first operated. A dry pump of the roots type equipped with multi-stages, recently being developed to reach a lower ultimate pressure of several Pa, is available.

To evacuate the system, 67 pumping units are placed at each chamber and every 100m along the 3-km tubes. After the tube pressure is reduced to be on the order of 10^{-5} Pa by operating turbo-molecular pumps, Spatter ion pumps are considered to be most convenient for further pumping and keeping the vacuum.

Glossary

SAS	Seismic Attenuation System
ECB	Electro-Chemical Buffing
DLC	Diamond-Like Carbon
TMP	Turbo Molecular Pump
SIP	Spatter Ion Pump

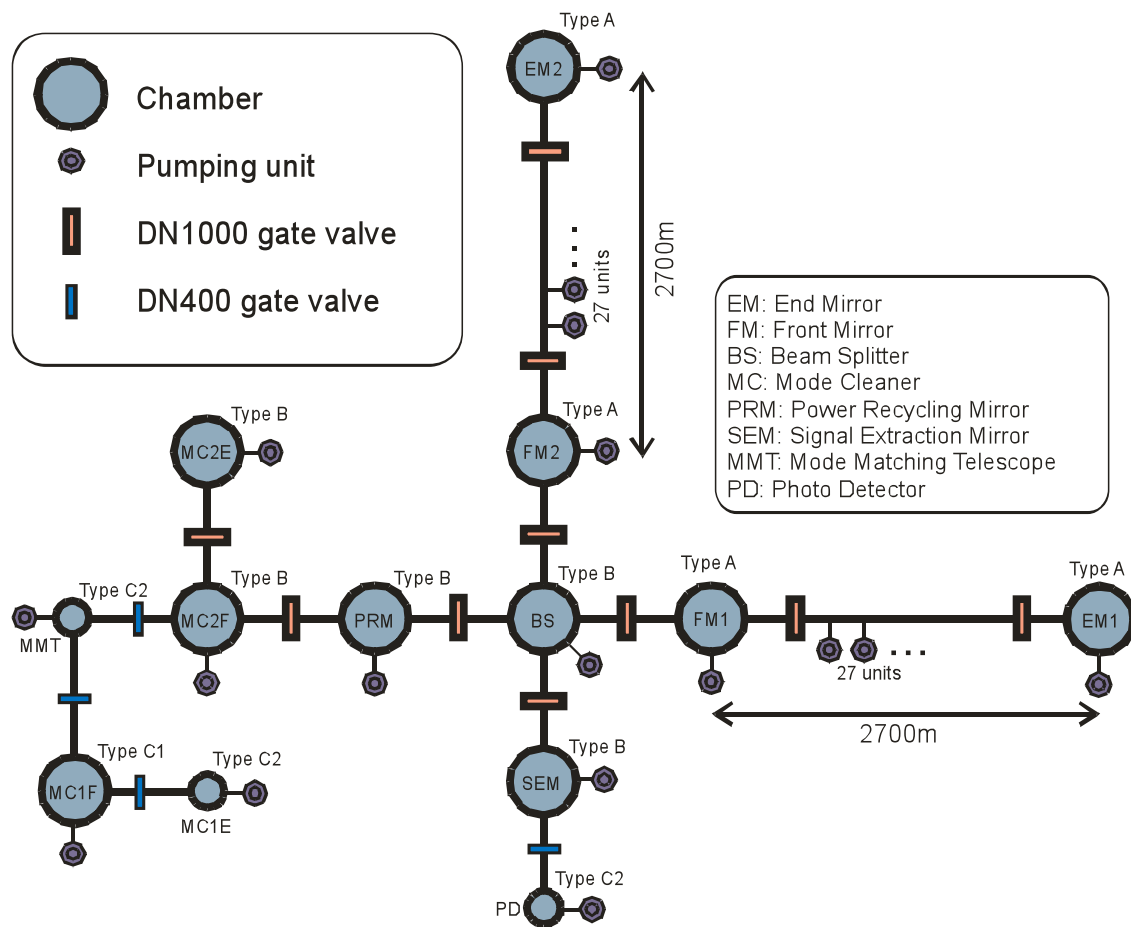

Figure: Schematic drawing of the vacuum-system design.

Table: Specification of the vacuum system

			#	Electric	Interface
Beam tube			2		
Pressure	2×10^{-7} Pa				
Length	3km				
Diameter	1m				
Height of cenetr	1.2m				SPI
Connection	Flange with Helicoflex				
Module tube			450		
Length	12m				
Thickness	8mm				
Material	SUS304L with ECB				
Bellows			450		
Length	0.7m				
Thickness	1mm				
Height	20mm (16wave)				
Material	SUS316L				
Baffle			450		
Height	50mm				
Angle	45°				
Material	SUS304 with DLC coatings				
Chamber					
Pressure	2×10^{-5} Pa				
Type A	2m ϕ x (3.5m + cryostat 3m)		4		SAS, Cryostat
Type B	2m ϕ x 4.5m		5		SAS, Stack
Type C1	2m ϕ x 3m		1		Stack
Type C2	1m ϕ x 2m		3		Stack
Material	SUS304 with ECB				
Viewport	DN160		?		IFO
Feedthrough	DN160		?		Control
Gate valve	DN1000		10		
Gate valve	DN400		4		
Initial pumping			10		
Root pump	100m ³ /h			AC200V	
Main pumping unit			67		
TMP	1m ³ /s			AC200V	
SIP	1m ³ /s			AC200V	
Dry pump	15m ³ /h			AC200V	
Vacuum gauge	$10^{-7} - 10^5$ Pa			AC100V	DAQ
Gate valve	DN200		(2)		
Angle valve	DN40		(3)		

Interface Control Document of the LCGT Project

Subgroup Name	Data Acquisition System
Subgroup Leader	Daisuke Tatsumi National astronomical observatory of Japan

Glossary

GPS	Global Positioning system
DAQ	Data Acquisition System
ADC	Analog to Digital Converter
bps	bit per second (a unit to indicate data flow capability)

1. Definition of subsystem

This subsystem should collect data from an interferometric detector.

Data storage, distribution and pre-processing for GW search are also provided for collaborators.

2. Task area

No.	Function	Hardware, software
1	Main DAQ system	Analog Digital Converter, Signal conditioning filter (whitening filter)
2	Frame Maker	Computer: Real time operation system to storage data with GW FRAME FORMAT.
3	Detector Diagnosis	Computer: Online data analysis soft for detector diagnosis and trend-data archive
4	Environment Monitor	Computer: Environmental data monitoring soft, display for user interface.
5	Time Keeper and Global Positioning System	GPS, GPS signal transmission system, GPS time server with Rubidium atomic clock, sampling clock distribution system for ADC and DAC.
6	Raw Data Archive	Computer, tape archive system and data storage system: Archived data database and its human interface.
7	Pre Analysis Server	Computer: Data re-formatting for GW signal search
8	Data Distribution	Computer and high-speed network: Data distribution system for collaborator's demands

2. Required specifications

	Item	Requirements
Main DAQ	Sampling rate	32768 Hz (down-sample from 65536 Hz)
	Number of channels	32
	Bit resolution	24 bit (4 byte integer)
	Anti-alias filter	10 kHz cut-off
	Data rate	4 MB/sec
	Frame length	1 second (32768 samples)
Frame builder	Operation system	UNIX
	(minimum) Hard disk	14.4 GB/hour x 70 hours = 1 TB
	Network interface	Gigabit Ethernet with optical fiber
Detector diagnosis	Sampling rate	16384 Hz (down-sample from 65536 Hz)
	Number of channels	512 CH = 64 CH x 8 stations
	Bit resolution	16 bit (2 byte integer)
	Anti-alias filter	5 kHz cut-off
	Data rate	2 MB/sec x 8 stations
Environmental monitor	Sampling rate	32 Hz (down-sample from 65536 Hz)
	Number of channels	512 CH = 64 CH x 8 stations
	Bit resolution	16 bit (2 byte integer)
	Anti-alias filter	10 Hz cut-off
	Data rate	2 kB/sec x 8 stations
Timing system and Global Positioning System	Time accuracy	< 1 micro sec
Raw data archive	from Main DAQ	4 MB/sec = 14.1 GB/hour
	from Diagnosis	2 MB/sec x 8 = 56.3 GB/hour
	from Environmental	2 kB/sec x 8 = 0.05 GB/hour
	Total data rate	20 MB/sec = 70.4 GB/hour
	Total data storage	100 TB in minimum
Pre analysis server	Computing power	300G Flops in minimum
Data Distribution	Network interface	Gigabit Ethernet with optical fiber

3. Interface between systems

Item	Related sub-system	Requirement	Confirmation
Observation band	Data analysis	10 Hz - 10 kHz	by DAS
ADC bit resolution	Data analysis	> 16 bits	by DAS
Number of channels for GW search	Data analysis	32 channels	by DAS
Pre-processed data formats	Data analysis	TBD	not yet
Acceptable delay time to distribute observation data for collaborators	Data analysis	< 1 hour	not yet
Data storage capability	Data analysis	100T bytes in minimum	not yet
Accuracy of time	Data analysis	< 1us	not yet
Computational capability for GW searches	Data analysis	300G Flops in minimum	not yet
Network capability	Infrastructure	10Gbps spec network switches Each 16 ports for 8 DAQ stations	not yet
Power consumption	Infrastructure	100 kW	not yet
Waist heat	Infrastructure	90 kW	not yet
Location and space	Infrastructure	24 m ² + 8 Racks	not yet
Installation schedule	Management	until 4th year end	not yet
Budget allocation	Management	50,000,000 Jpn Yen	not yet
Man power allocation	Management	2 person x 5 years	not yet

1. 各サブシステムの簡単な定義 / Concise definition of Data Analysis

LCGT 建設完了までに各サブグループが責任を持って提供すべき機能と、それを実現するためのハードウェア、ソフトウェア。

No.	機能 / Function	Hardware, Software
1	Computing power and software for event searches	Main Server, Network infrastructure, C, Matlab, etc.
2	Interface for grid computing as an international GW detector network	GRID server for distributed computing environment, Network infrastructure
3	Interface for LCGT collaborators as data center including document control	Main Server, Network infrastructure, Library management software (e.g. CVS)
4	Calibration Routine	Software and parameter table for calibration
5	Interface for external triggers such as GRB and SNs.	Main Server, Network infrastructure, C, Matlab, etc.
6	GW alert system	Main Server, Network infrastructure, C, Matlab, etc.
7	Interface for distributed computing system based on BOINIC (*)	Main Server, Network infrastructure, BOINIC
8	Processed data server	Mass storage for processed (calibrated) data sharing and distribution

* <http://boinc.oocp.org/indexj.php> : Software platform for Einstein@home

2. 要求仕様 / Required specifications for Data Analysis

1で示した機能に対する要求仕様が記述されている LCGT design document version 2 での section 番号、関連 sub-system、Design document version 2 からの変更の有無と可能性。

No.	機能 / Function	Described section (**)	Related sub-system(s)	変更有り modified	変更の可能 性有り to be modified
1	Computing Power		Data Analysis Subsystem	<input type="checkbox"/>	<input type="checkbox"/>
2	Data storage and archive		Data Analysis Subsystem Data Acquisition Subsystem	<input type="checkbox"/>	<input type="checkbox"/>
3	Commercially available software and libraries		Data Analysis Subsystem	<input type="checkbox"/>	<input type="checkbox"/>
4	Grid system		Data Analysis Subsystem	<input type="checkbox"/>	<input type="checkbox"/>
5	Database for stored data		Data Analysis Subsystem	<input type="checkbox"/>	<input type="checkbox"/>
6	Document control and archive		Data Analysis Subsystem	<input type="checkbox"/>	<input type="checkbox"/>
7	Interface for external trigger		Data Analysis Subsystem	<input type="checkbox"/>	<input type="checkbox"/>
8	GW alert system		Data Analysis Subsystem Data Acquisition Subsystem	<input type="checkbox"/>	<input type="checkbox"/>
9	Interface for BOINIC		Data Analysis Subsystem	<input type="checkbox"/>	<input type="checkbox"/>

** Section in LCGT Design Document, Version 2

3. インターフェース / Interface of the Data Analysis

各サブシステムの詳細設計を行うにあたり、決定しなければならない仕様、他のサブシステムで決めて欲しい仕様、もしくは合意されている仕様

* 実際に建設が始まったら決まっていないと困ること、建設完了までに決まっていないといけないこと。

	事項 / Item	関連サブシステム / Related sub-system	要求値 / Value	合意済 / Confirmed
*	Computing power	DAS	TBD	Not yet
*	Amount of data storage	DAS	TBD	Not yet
*	Data archive system	DAS, DAQ	TBD	Not yet
	Commercial software	DAS	TBD	Not yet
	Commercial libraries	DAS	TBD	Not yet
*	Database for stored data	DAS	TBD	Not yet
*	Document control and archive	DAS	TBD	Not yet
	External triggers	DAS	TBD	Not yet
	GW alert system	DAS, DAQ	TBD	Not yet

↑ 当該サブシステムが決めないといけないことには * 印を付けること。

Subgroup Name	Data Analysis Subsystem
Subgroup Leader	Hideyuki Tagoshi Osaka University

Doc version	Date	Description
Rev. A-0	2009-05-27	Kick-off draft
Rev. A-0	2009-06-02	Modified by Tagoshi
Rev. A-0	2009-06-03	Submitted to Kuroda

Glossary

NS	Neutron Star
BH	Black Hole
SN	Supernovae
SNR, S/N	Signal-to-Noise Ratio
GW	Gravitational Wave
inspiral	The inspiral of the coalescing compact binaries
CBC	Compact Binary Coalescence
DAQ	Data Acquisition Subsystem
ACS	Analysis Center Subsystem

1. 各サブシステムの簡単な定義 / Concise definition of Data Analysis

LCGT 建設完了までに各サブグループが責任を持って提供すべき機能と、それを実現するためのハードウェア、ソフトウェア。

No.	機能 / Function	GW sources / Search Methods
1	International network GW searches	Compact Binary Coalescences, Stochastic backgrounds, Bursts, All sky pulsar searches
2	LCGT standalone GW searches	External triggered search for CBC and Burst sources, Known pulsars searches, new search method developments, novel GW source searches
3	Astrophysical interpretation of GW search results	

2. 要求仕様 / Required specifications for Data Analysis

1で示した機能に対する要求仕様が記述されている LCGT design document version 2 での section 番号、関連 sub-system、Design document version 2 からの変更の有無と可能性。

No.	機能 / Function	Described section (**)	Related sub-system(s)	変更有り modified	変更の可能 性有り to be modified
1	CBC search	2.1, 2.4, 18.2.1, 18.4	Analysis Center Subsystem	<input type="checkbox"/>	<input type="checkbox"/>
2	Burst search	2.3, 2.4, 18.2.2, 18.4	Analysis Center Subsystem	<input type="checkbox"/>	<input type="checkbox"/>
3	Periodic source search	2.2, 18.2.3, 18.4	Analysis Center Subsystem	<input type="checkbox"/>	<input type="checkbox"/>
4	BH ringdown search	2.1.2, 2.3, 2.4, 18.4	Analysis Center Subsystem	<input type="checkbox"/>	<input type="checkbox"/>
5	Stochastic GW search	none	Analysis Center Subsystem	<input type="checkbox"/>	<input type="checkbox"/>
6	Data quality and character check	17.4	Data Acquisition Subsystem Analysis Center Subsystem	<input type="checkbox"/>	<input type="checkbox"/>
7	International collaboration	18.3	Analysis Center Subsystem	<input type="checkbox"/>	<input type="checkbox"/>
8				<input type="checkbox"/>	<input type="checkbox"/>
9				<input type="checkbox"/>	<input type="checkbox"/>

** Section in LCGT Design Document, Version 2

3. インターフェース / Interface of the Data Analysis

各サブシステムの詳細設計を行うにあたり、決定しなければならない仕様、他のサブシステムで決めて欲しい仕様、もしくは合意されている仕様

* 実際に建設が始まったら決まっていないと困ること、建設完了までに決まっていないといけないこと。

	事項 / Item	関連サブシステム / Related sub-system	要求値 / Value	合意済 / Confirmed
	Observable frequency range	DAQ	10 Hz - 10 kHz	
	ADC bit resolution	DAQ	> 16 bits	
	Search task data format	DAQ	TBD	Not yet
	Calibration code and data	DAQ	TBD	Not yet
	Data distribution method	DAQ, ACS	TBD	Not yet
*	Analysis computer system	DAQ, ACS	TBD	Not yet
*	CBC search code	ACS	TBD	Not yet
*	Burst search code	ACS	TBD	Not yet
*	Periodic source search code	ACS	TBD	Not yet
*	BH Ringdown search code	ACS	TBD	Not yet
*	Stochastic GW search code	ACS	TBD	Not yet
*	Data quality and character check code	ACS	TBD	Not yet
	human resource management	ACS	TBD	Not yet
	International collaboration	ACS	TBD	Not yet

↑ 当該サブシステムが決めないといけないことには * 印を付けること。